

### FEATURES

- Sample Rate: 175ksps
- 16-Bit No Missing Codes and  $\pm 3$ LSB Max INL
- 8-Channel Multiplexer with:
  - Single Ended or Differential Inputs and
  - Unipolar or Bipolar Conversion Modes
- SPI/MICROWIRE Serial I/O
- 2.7V Guaranteed Supply Voltage
- Pin Compatible with LTC1863/LTC1867
- True Differential Inputs
- On-Chip or External Reference
- Low Power: 750 $\mu$ A at 175ksps, 300 $\mu$ A at 50ksps
- Sleep Mode
- Automatic Nap Mode Between Conversions
- 16-Pin Narrow SSOP Package

### APPLICATIONS

- Industrial Process Control
- High Speed Data Acquisition
- Battery Operated Systems
- Multiplexed Data Acquisition Systems
- Imaging Systems

### DESCRIPTION

The [LTC<sup>®</sup>1863L/LTC1867L](#) are pin compatible, 8-channel 12-/16-bit A/D converters with serial I/O and an internal reference.

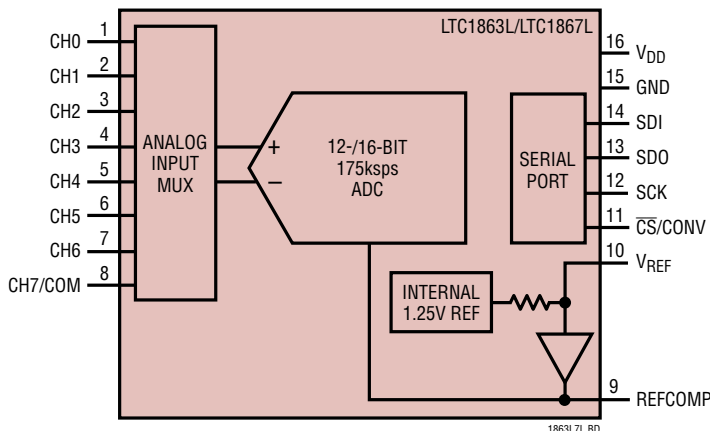
The 8-channel input multiplexer can be configured for either single-ended or differential inputs and unipolar or bipolar conversions (or combinations thereof). The ADCs convert 0V to 2.5V unipolar inputs or  $\pm 1.25$ V bipolar inputs. The ADCs typically draw only 750 $\mu$ A from a single 2.7V supply. The automatic nap and sleep modes benefit power sensitive applications.

The LTC1867L's DC performance is outstanding with a  $\pm 3$ LSB INL specification and 16-bit no missing codes over temperature.

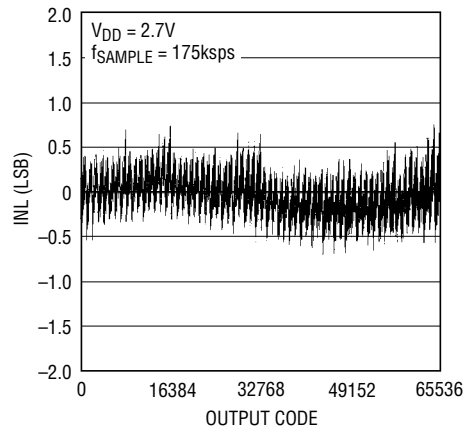
Housed in a compact, narrow 16-pin SSOP package, the LTC1863L/LTC1867L can be used in space-sensitive as well as low power applications.

All registered trademarks and trademarks are the property of their respective owners.

### BLOCK DIAGRAM



**Integral Nonlinearity vs Output Code  
(LTC1867L)**



1863L7L G01

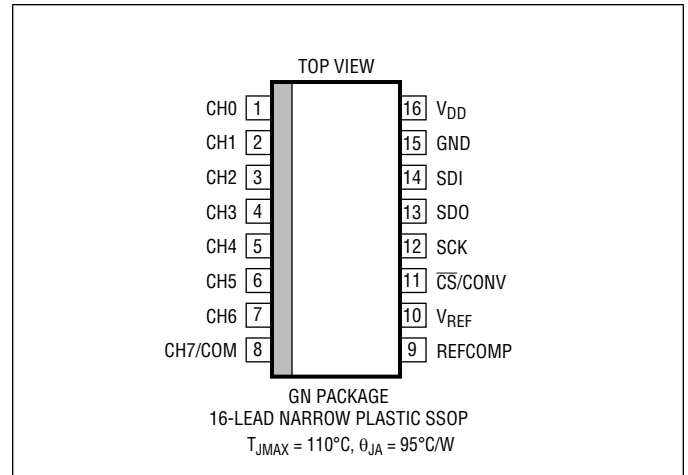
# LTC1863L/LTC1867L

## ABSOLUTE MAXIMUM RATINGS

(Notes 1, 2)

Supply Voltage ( $V_{DD}$ ) .....	-0.3V to 6V
Analog Input Voltage	
CH0-CH7/COM (Note 3) .....	-0.3V to ( $V_{DD} + 0.3V$ )
$V_{REF}$ , REFCOMP (Note 4) .....	-0.3V to ( $V_{DD} + 0.3V$ )
Digital Input Voltage (SDI, SCK, $\overline{CS}/CONV$ )	
(Note 4) .....	-0.3V to 10V
Digital Output Voltage (SDO) .....	-0.3V to ( $V_{DD} + 0.3V$ )
Power Dissipation .....	500mW
Operating Temperature Range	
LTC1863LC/LTC1867LC/LTC1867LAC .....	0°C to 70°C
LTC1863LI/LTC1867LI/LTC1867LAI .....	-40°C to 85°C
Storage Temperature Range .....	-65°C to 150°C
Lead Temperature (Soldering, 10 sec) .....	300°C

## PIN CONFIGURATION



Consult ADI Marketing for parts specified with wider operating temperature ranges.

## ORDER INFORMATION <http://www.linear.com/product/LTC1863L#orderinfo>

LEAD FREE FINISH	TAPE AND REEL	PART MARKING*	PACKAGE DESCRIPTION	TEMPERATURE RANGE
LTC1863LCGN#PBF	LTC1863LCGN#TRPBF	1863L	16-Lead Narrow Plastic SSOP	0°C to 70°C
LTC1863LIGN#PBF	LTC1863LIGN#TRPBF	1863L	16-Lead Narrow Plastic SSOP	-40°C to 85°C
LTC1867LCGN#PBF	LTC1867LCGN#TRPBF	1867L	16-Lead Narrow Plastic SSOP	0°C to 70°C
LTC1867LIGN#PBF	LTC1867LIGN#TRPBF	1867L	16-Lead Narrow Plastic SSOP	-40°C to 85°C
LTC1867LACGN#PBF	LTC1867LACGN#TRPBF	1867L	16-Lead Narrow Plastic SSOP	0°C to 70°C
LTC1867LAIGN#PBF	LTC1867LAIGN#TRPBF	1867L	16-Lead Narrow Plastic SSOP	-40°C to 85°C

Consult ADI Marketing for parts specified with wider operating temperature ranges. \*The temperature grade is identified by a label on the shipping container.

For more information on lead free part marking, go to: <http://www.linear.com/leadfree/>

For more information on tape and reel specifications, go to: <http://www.linear.com/tapeandreel/>. Some packages are available in 500 unit reels through designated sales channels with #TRMPBF suffix.

## CONVERTER CHARACTERISTICS

The ● denotes the specifications which apply over the full operating temperature range, otherwise specifications are at  $T_A = 25^\circ\text{C}$ .  $V_{DD} = 2.7V$ , external  $V_{REF} = 1.25V$  (Notes 5, 6)

PARAMETER	CONDITIONS		LTC1863L			LTC1867L			LTC1867LA			UNITS
			MIN	TYP	MAX	MIN	TYP	MAX	MIN	TYP	MAX	
Resolution		●	12			16			16			Bits
No Missing Codes		●	12			15			16			Bits
Integral Linearity Error	Unipolar (Note 7)	●			±1			±4			±3	LSB
	Bipolar	●			±1			±4			±3	LSB
Differential Linearity Error		●			±1	-2			-1			LSB
Transition Noise				0.1			1.6			1.6		LSB <sub>RMS</sub>
Offset Error	Unipolar (Note 8)	●			±3			±32			±32	LSB
	Bipolar	●			±4			±64			±64	LSB
Offset Error Match	Unipolar				±1			±4			±3	LSB
	Bipolar				±1			±4			±3	LSB
Offset Error Drift				±0.5			±0.5			±0.5		ppm/°C

186317Ifc

**CONVERTER CHARACTERISTICS** The ● denotes the specifications which apply over the full operating temperature range, otherwise specifications are at  $T_A = 25^\circ\text{C}$ .  $V_{DD} = 2.7\text{V}$ , external  $V_{REF} = 1.25\text{V}$  (Notes 5, 6)

PARAMETER	CONDITIONS	LTC1863L			LTC1867L			LTC1867LA			UNITS
		MIN	TYP	MAX	MIN	TYP	MAX	MIN	TYP	MAX	
Gain Error	Unipolar			±6			±96			±64	LSB
	Bipolar			±6			±96			±64	LSB
Gain Error Match	Unipolar			±1			±4			±3	LSB
	Bipolar			±1			±4			±3	LSB
Gain Error Tempco	Internal Reference		±20			±20			±20		ppm/°C
	External Reference		±3			±3			±3		ppm/°C
Power Supply Sensitivity	$V_{DD} = 2.7\text{V} - 3.6\text{V}$		±1			±3			±3		LSB

**DYNAMIC ACCURACY**  $V_{DD} = 3\text{V}$ , external  $V_{REF} = 1.25\text{V}$  (Note 5)

SYMBOL	PARAMETER	CONDITIONS	LTC1863L			LTC1867L/LTC1867LA			UNITS
			MIN	TYP	MAX	MIN	TYP	MAX	
SNR	Signal-to-Noise Ratio	1kHz Input Signal		73.1			83.7		dB
S/(N+D)	Signal-to-(Noise + Distortion) Ratio	1kHz Input Signal		73			83.1		dB
THD	Total Harmonic Distortion	1kHz Input Signal, Up to 5th Harmonic		-91.8			-92.3		dB
	Peak Harmonic or Spurious Noise	1kHz Input Signal		-94.8			-95.1		dB
	Channel-to-Channel Isolation	100kHz Input Signal		-100			-112		dB
	Full Power Bandwidth	-3dB Point		1.25			1.25		MHz

**ANALOG INPUT** The ● denotes the specifications which apply over the full operating temperature range, otherwise specifications are at  $T_A = 25^\circ\text{C}$ . (Note 5)

SYMBOL	PARAMETER	CONDITIONS	LTC1863L/LTC1867L/LTC1867LA			UNITS	
			MIN	TYP	MAX		
	Analog Input Range	Unipolar Mode (Note 9)		0 to 2.5		V	
		Bipolar Mode		±1.25		V	
$C_{IN}$	Analog Input Capacitance for CH0 to CH7/COM	Between Conversions (Sample Mode)		32		pF	
		During Conversions (Hold Mode)		4		pF	
$t_{ACQ}$	Sample-and-Hold Acquisition Time		●	2.01	1.68	μs	
	Input Leakage Current	On Channels, CHX = 0V or $V_{DD}$		●		±1	μA

**INTERNAL REFERENCE CHARACTERISTICS** (Note 5)

PARAMETER	CONDITIONS	LTC1863L/LTC1867L/LTC1867LA			UNITS
		MIN	TYP	MAX	
$V_{REF}$ Output Voltage	$I_{OUT} = 0$	1.235	1.25	1.265	V
$V_{REF}$ Output Tempco	$I_{OUT} = 0$		±20		ppm/°C
$V_{REF}$ Line Regulation	$2.7\text{V} \leq V_{DD} \leq 3.6\text{V}$		0.3		mV/V
$V_{REF}$ Output Resistance	$ I_{OUT}  \leq 0.1\text{mA}$		3		kΩ
REFCOMP Output Voltage	$I_{OUT} = 0$		2.5		V

**DIGITAL INPUTS AND DIGITAL OUTPUTS** The ● denotes the specifications which apply over the full operating temperature range, otherwise specifications are at  $T_A = 25^\circ\text{C}$ . (Note 5)

SYMBOL	PARAMETER	CONDITIONS	LTC1863L/LTC1867L/LTC1867LA			UNITS
			MIN	TYP	MAX	
$V_{IH}$	High Level Input Voltage	$V_{DD} = 3.6\text{V}$	●	1.9		V
$V_{IL}$	Low Level Input Voltage	$V_{DD} = 2.7\text{V}$	●		0.45	V

# LTC1863L/LTC1867L

## DIGITAL INPUTS AND DIGITAL OUTPUTS

The ● denotes the specifications which apply over the full operating temperature range, otherwise specifications are at  $T_A = 25^\circ\text{C}$ . (Note 5)

SYMBOL	PARAMETER	CONDITIONS	LTC1863L/LTC1867L/LTC1867LA			UNITS
			MIN	TYP	MAX	
$I_{IN}$	Digital Input Current	$V_{IN} = 0V$ to $V_{DD}$	●		±10	μA
$C_{IN}$	Digital Input Capacitance			2		pF
$V_{OH}$	High Level Output Voltage (SDO)	$V_{DD} = 2.7V, I_O = -10\mu A$ $V_{DD} = 2.7V, I_O = -200\mu A$	●	23	2.68 2.65	V V
$V_{OL}$	Low Level Output Voltage (SDO)	$V_{DD} = 2.7V, I_O = 160\mu A$ $V_{DD} = 2.7V, I_O = 1.6\mu A$	●		0.05 0.15	V V
$I_{SOURCE}$	Output Source Current	SDO = 0V			-9.7	mA
$I_{SINK}$	Output Sink Current	SDO = $V_{DD}$			6	mA
	Hi-Z Output Leakage	$\overline{CS}/CONV = \text{High}, SDO = 0V$ or $V_{DD}$	●		±10	μA
	Hi-Z Output Capacitance	$\overline{CS}/CONV = \text{High}$ (Note 10)	●		15	pF
	Data Format	Unipolar Bipolar			Straight Binary Two's Complement	

## POWER REQUIREMENTS

The ● denotes the specifications which apply over the full operating temperature range, otherwise specifications are at  $T_A = 25^\circ\text{C}$ . (Note 5)

SYMBOL	PARAMETER	CONDITIONS	LTC1863L/LTC1867L/LTC1867LA			UNITS	
			MIN	TYP	MAX		
$V_{DD}$	Supply Voltage	(Note 9)		2.7	3.6	V	
$I_{DD}$	Supply Current	$f_{SAMPLE} = 175\text{ksps}$ , Internal REF	●		0.75	mA	
		NAP Mode	●		170	μA	
		SLEEP Mode	●		0.2	3	μA
$P_{DISS}$	Power Dissipation	$f_{SAMPLE} = 175\text{ksps}$	●		2	2.7	mW

## TIMING CHARACTERISTICS

The ● denotes the specifications which apply over the full operating temperature range, otherwise specifications are at  $T_A = 25^\circ\text{C}$ . (Note 5)

SYMBOL	PARAMETER	CONDITIONS	LTC1863L/LTC1867L/LTC1867LA			UNITS	
			MIN	TYP	MAX		
$f_{SAMPLE}$	Maximum Sampling Frequency		●	175		kHz	
$t_{CONV}$	Conversion Time		●		3.2	3.7	μs
$t_{ACQ}$	Acquisition Time		●	2.01	1.68		μs
$f_{SCK}$	SCK Frequency					20	MHz
$t_1$	$\overline{CS}/CONV$ High Time	Short $\overline{CS}/CONV$ Pulse Mode	●	40	100		ns
$t_2$	SDO Valid After SCK↓	$C_L = 25\text{pF}$ (Note 11)	●		22	47	ns
$t_3$	SDO Valid Hold Time After SCK↓	$C_L = 25\text{pF}$	●	5	17		ns
$t_4$	SDO Valid After $\overline{CS}/CONV$ ↓	$C_L = 25\text{pF}$	●		20	40	ns
$t_5$	SDI Setup Time Before SCK↑		●	15	-6		ns
$t_6$	SDI Hold Time After SCK↑		●	15	6		ns
$t_7$	SLEEP Mode Wake-Up Time	$C_{REFCOMP} = 10\mu F, C_{VREF} = 2.2\mu F$			80		ms
$t_8$	Bus Relinquish Time After $\overline{CS}/CONV$ ↑	$C_L = 25\text{pF}$	●		30	50	ns

**Note 1:** Stresses beyond those listed under Absolute Maximum Ratings may cause permanent damage to the device. Exposure to any Absolute Maximum Rating condition for extended periods may affect device reliability and lifetime.

**Note 2:** All voltage values are with respect to GND (unless otherwise noted).

**Note 3:** When these pin voltages are taken below GND or above  $V_{DD}$ , they will be clamped by internal diodes. This product can handle input currents up to 100mA without latchup.

**TIMING CHARACTERISTICS** The ● denotes the specifications which apply over the full operating temperature range, otherwise specifications are at  $T_A = 25^\circ\text{C}$ . (Note 5)

**Note 4:** When these pin voltages are taken below GND, they will be clamped by internal diodes. This product can handle input currents up to 100mA below GND without latching. These pins are not clamped to  $V_{DD}$ .

**Note 5:**  $V_{DD} = 2.7\text{V}$ ,  $f_{\text{SAMPLE}} = 175\text{ksps}$  and  $f_{\text{SCK}} = 20\text{MHz}$  at  $25^\circ\text{C}$ ,  $t_r = t_f = 5\text{ns}$  and  $V_{\text{IN}^-} = 1.25\text{V}$  for bipolar mode unless otherwise specified.

**Note 6:** Linearity, offset and gain error specifications apply for both unipolar and bipolar modes. The INL and DNL are tested in bipolar mode.

**Note 7:** Integral nonlinearity is defined as the deviation of a code from a straight line passing through the actual endpoints of the transfer curve. The deviation is measured from the center of the quantization band.

**Note 8:** Unipolar offset is the offset voltage measured from  $+1/2\text{LSB}$  when the output code flickers between 0000 0000 0000 0000 and 0000 0000 0000 0001 for LTC1867L and between 0000 0000 0000 and 0000 0000 0001 for LTC1863L. Bipolar offset is the offset voltage

measured from  $-1/2\text{LSB}$  when output code flickers between 0000 0000 0000 0000 and 1111 1111 1111 1111 for LTC1867L, and between 0000 0000 0000 and 1111 1111 1111 for LTC1863L.

**Note 9:** Recommended operating conditions. The input range of  $\pm 1.25\text{V}$  for bipolar mode is measured with respect to  $V_{\text{IN}^-} = 1.25\text{V}$ . For unipolar mode, common mode input range is 0V to  $V_{DD}$  for the positive input and 0V to 1.5V for the negative input. For bipolar mode, common mode input range is 0V to  $V_{DD}$  for both positive and negative inputs.

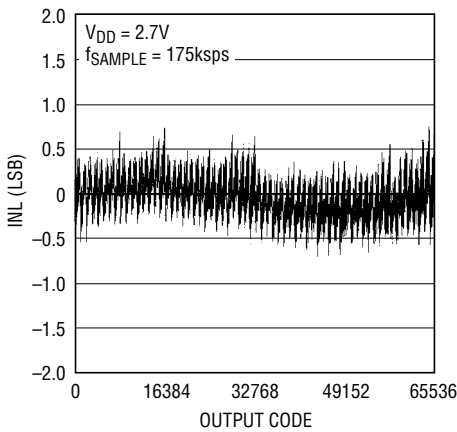
**Note 10:** Guaranteed by design, not subject to test.

**Note 11:**  $t_2$  of 47ns maximum allows  $f_{\text{SCK}}$  up to 10MHz for rising capture with 50% duty cycle and  $f_{\text{SCK}}$  up to 20MHz for falling capture (with 3ns setup time for the receiving logic).

**TYPICAL PERFORMANCE CHARACTERISTICS**

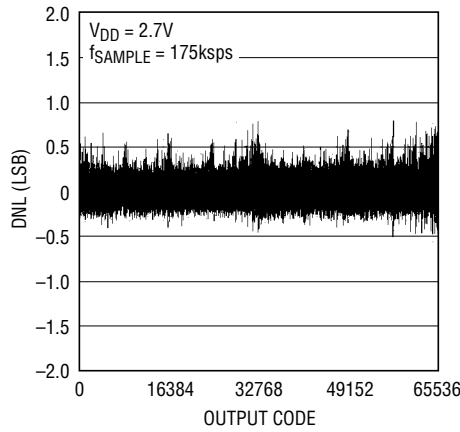
(LTC1867L)

**Integral Nonlinearity vs Output Code**



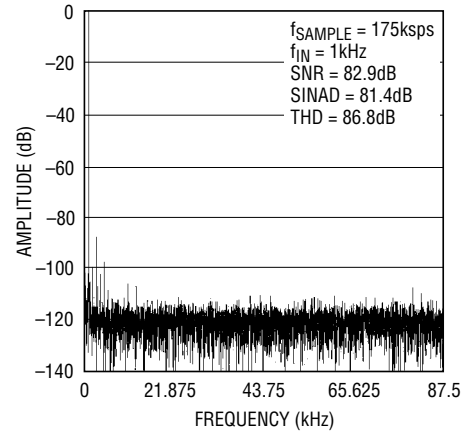
1863L7L G01

**Differential Nonlinearity vs Output Code**



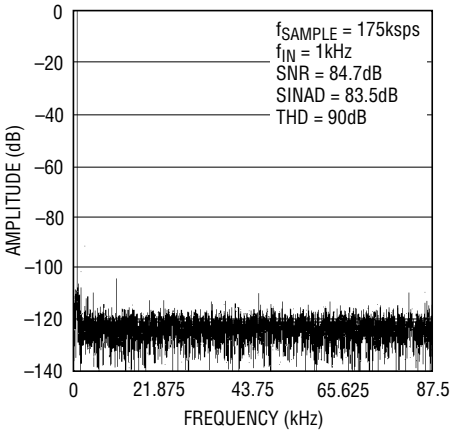
1863L7L G02

**4096 Points FFT Plot (VDD = 2.7V, Internal REF)**



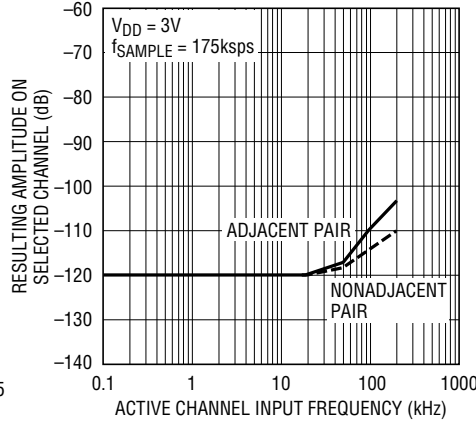
1863L7L G03

**4096 Points FFT Plot (VDD = 3V, REFCOMP = Ext 3V)**



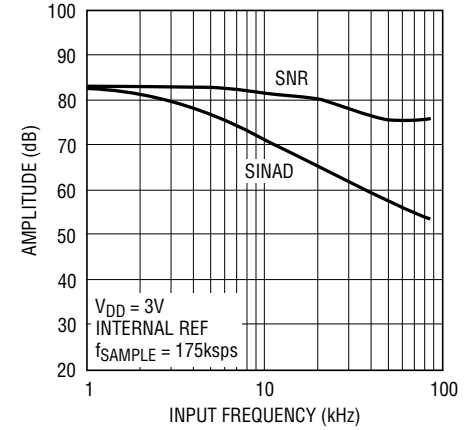
1863L7L G04

**Crosstalk vs Input Frequency**



1863L7L G05

**Signal-to-(Noise + Distortion) Ratio vs Input Frequency**



1863L7L G06

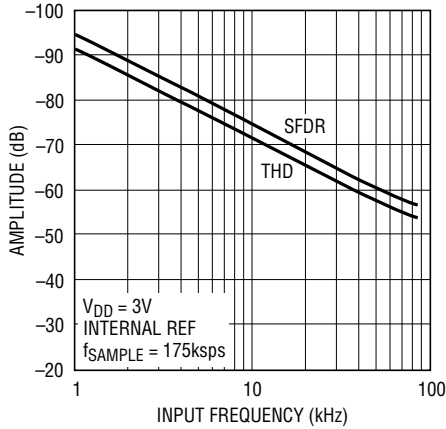
186317fe

# LTC1863L/LTC1867L

## TYPICAL PERFORMANCE CHARACTERISTICS

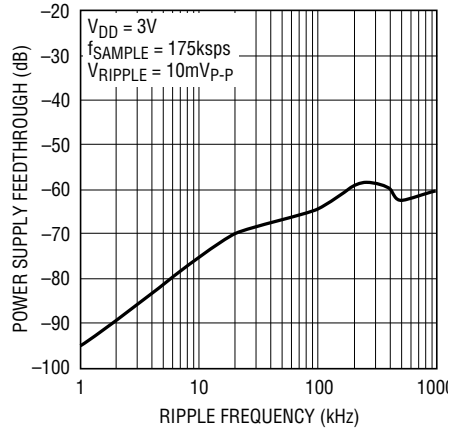
(LTC1867L)

**Total Harmonic Distortion vs Input Frequency**



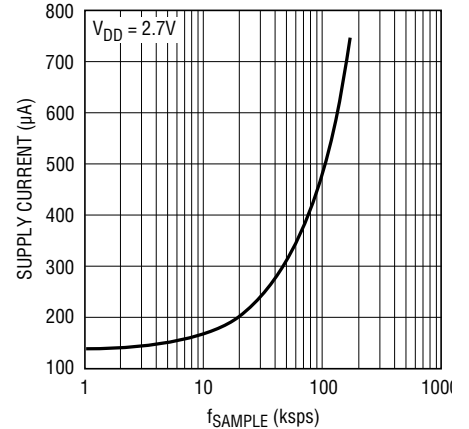
1863L7L G07

**Power Supply Feedthrough vs Ripple Frequency**



1863L7L G08

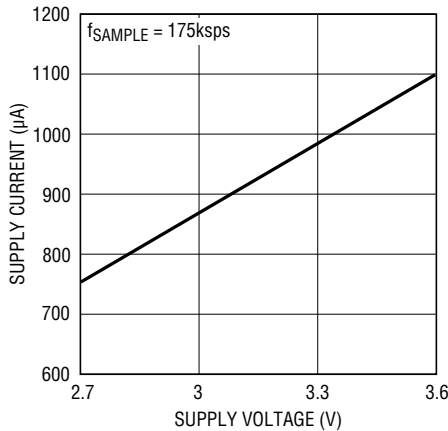
**Supply Current vs  $f_{SAMPLE}$  (LTC1863L/LTC1867L)**



1863L7L G09

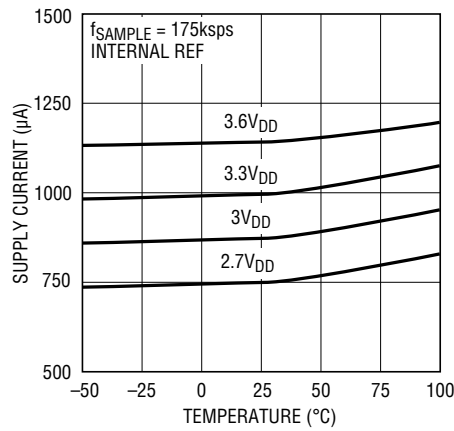
(LTC1863L/ LTC1867L)

**Supply Current vs Supply Voltage**



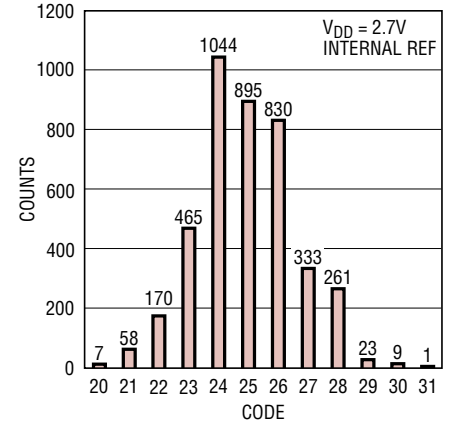
1963L7L G10

**Supply Current vs Temperature**



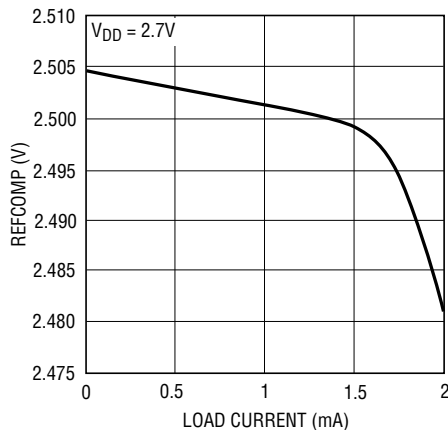
1863L7L G11

**Histogram for 4096 Conversions (LTC1867L)**



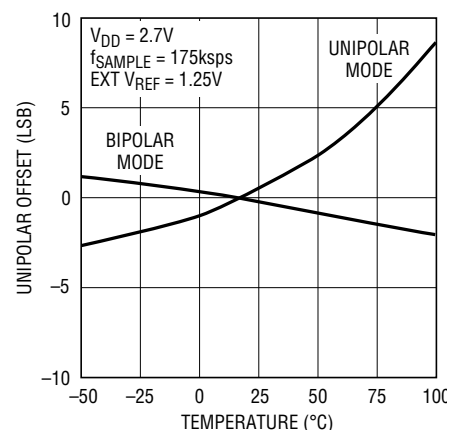
1863L7L G12

**REFCOMP vs Load Current**



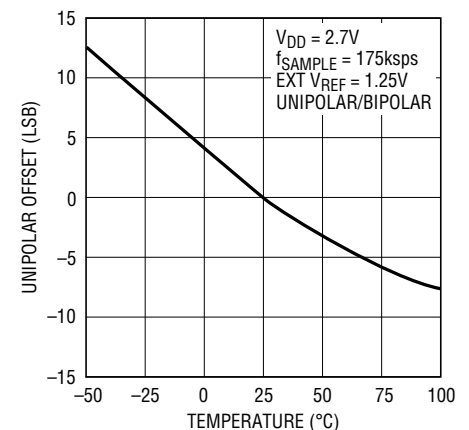
1863L7L G13

**Offset Drift (LTC1867L) vs Temperature**



1863L7L G14

**Gain Error Drift (LTC1867L) vs Temperature**

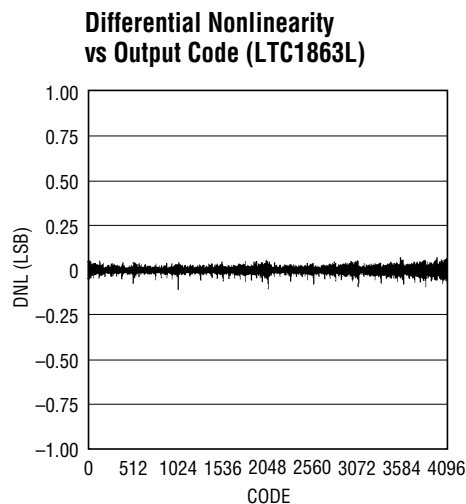
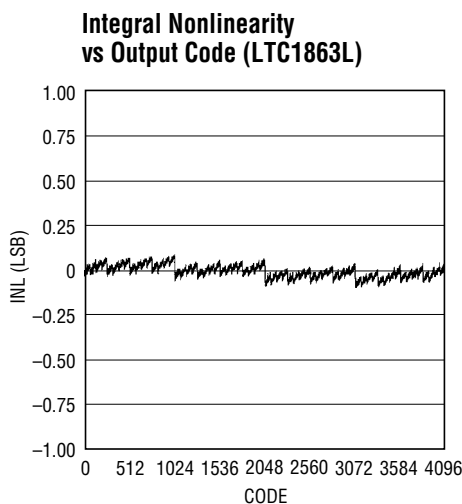


1863L7L G15

186317fe

## TYPICAL PERFORMANCE CHARACTERISTICS

(LTC1863L/ LTC1867L)



## PIN FUNCTIONS

**CHO-CH7/COM (Pins 1-8):** Analog Input Pins. Analog inputs must be free of noise with respect to GND. CH7/COM can be either a separate channel or the common minus input for the other channels. Unused channels should be tied to ground.

**REFCOMP (Pin 9):** Reference Buffer Output Pin. Bypass to GND with a 10 $\mu$ F tantalum capacitor in parallel with a 0.1 $\mu$ F ceramic capacitor (2.5V Nominal). To overdrive REFCOMP, tie  $V_{REF}$  to GND.

**$V_{REF}$  (Pin 10):** 1.25V Reference Output. This pin can also be used as an external reference buffer input for improved accuracy and drift. Bypass to GND with a 2.2 $\mu$ F tantalum capacitor in parallel with a 0.1 $\mu$ F ceramic capacitor.

**$\overline{CS}/CONV$  (Pin 11):** This input provides the dual function of initiating conversions on the ADC and also frames the serial data transfer.

**SCK (Pin 12):** Shift Clock. This clock synchronizes the serial data transfer.

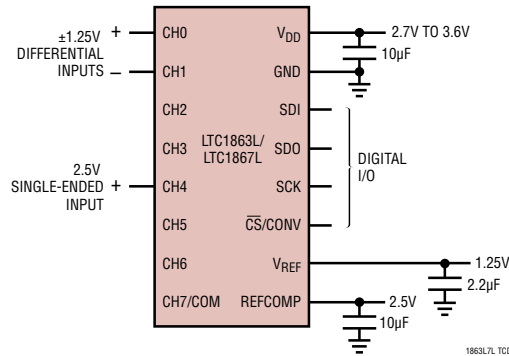
**SDO (Pin 13):** Digital Data Output. The A/D conversion result is shifted out of this output. Straight binary format for unipolar mode and two's complement format for bipolar mode.

**SDI (Pin 14):** Digital Data Input Pin. The A/D configuration word is shifted into this input.

**GND (Pin 15):** Analog and Digital GND.

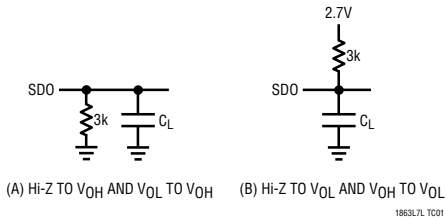
**$V_{DD}$  (Pin 16):** Analog and Digital Power Supply. Bypass to GND with a 10 $\mu$ F tantalum capacitor in parallel with a 0.1 $\mu$ F ceramic capacitor. When powering up the LTC1863L/LTC1867L, or any time  $V_{DD}$  falls below the minimum specified operating voltage, one dummy conversion must be initiated by providing a rising edge on the  $\overline{CS}/CONV$  pin. The first conversion result may be invalid and should be ignored. Once the  $\overline{CS}/CONV$  pin is returned low, a DIN word can be shifted into SDI to program the configuration for the next conversion. Wait at least  $t_7$ , the SLEEP Mode Wake-Up Time of 80ms, before initiating the second conversion to obtain a valid conversion result.

## TYPICAL CONNECTION DIAGRAM

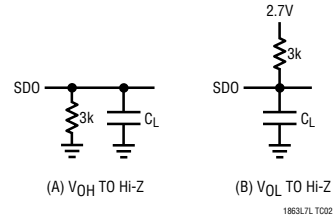


## TEST CIRCUITS

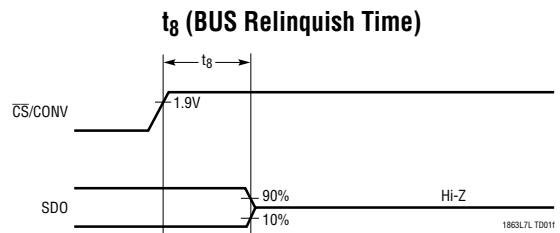
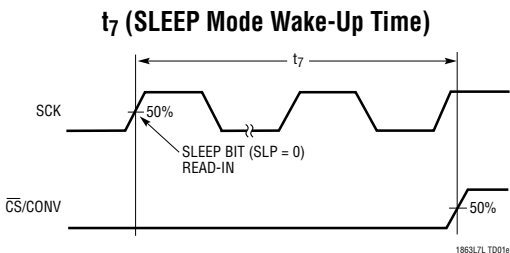
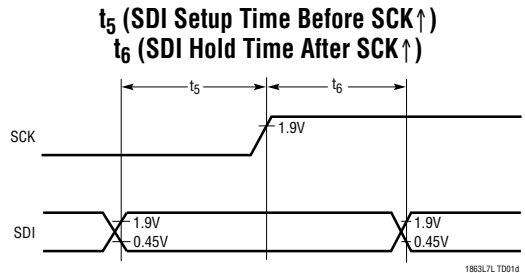
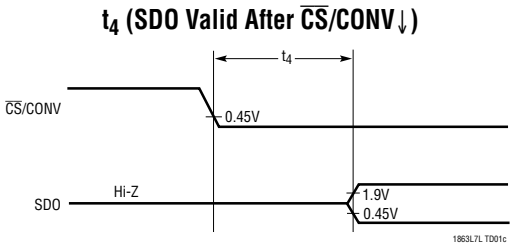
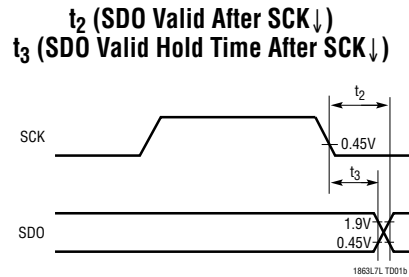
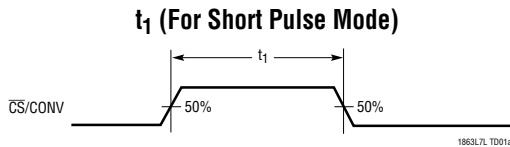
Load Circuits for Access Timing



Load Circuits for Output Float Delay



## TIMING DIAGRAMS





## APPLICATIONS INFORMATION

### Overview

The LTC1863L/LTC1867L are complete, low power, multiplexed ADCs. They consist of a 12-/16-bit, 175ksps capacitive successive approximation A/D converter, a precision internal reference, a configurable 8-channel analog input multiplexer (MUX) and a serial port for data transfer.

Conversions are started by a rising edge on the  $\overline{CS}/CONV$  input. Once a conversion cycle has begun, it cannot be restarted. Between conversions, the ADCs receive an input word for channel selection and output the conversion result, and the analog input is acquired in preparation for the next conversion. In the acquire phase, a minimum time of  $2.01\mu s$  will provide enough time for the sample-and-hold capacitors to acquire the analog signal.

During the conversion, the internal differential 16-bit capacitive DAC output is sequenced by the SAR from the most significant bit (MSB) to the least significant bit (LSB). The input is successively compared with the binary weighted charges supplied by the differential capacitive DAC. Bit decisions are made by a low power, differential comparator that rejects common mode noise. At the end of a conversion, the DAC output balances the analog input. The SAR content (a 12-/16-bit data word) that represents the analog input is loaded into the 12-/16-bit output latches. Analog Input Multiplexer

The analog input multiplexer is controlled by a 7-bit input data word. The input data word is defined as follows:

SD	OS	S1	S0	COM	UNI	SLP
----	----	----	----	-----	-----	-----

SD = SINGLE/DIFFERENTIAL BIT

OS = ODD/SIGN BIT

S1 = ADDRESS SELECT BIT 1

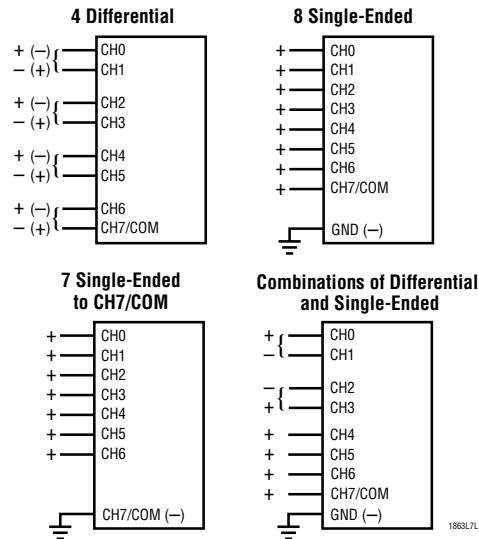
S0 = ADDRESS SELECT BIT 0

COM = CH7/COM CONFIGURATION BIT

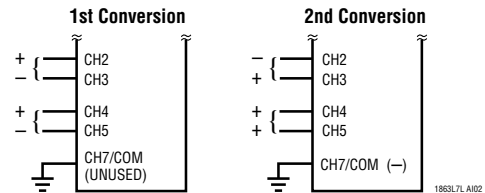
UNI = UNIPOLAR/BIPOLAR BIT

SLP = SLEEP MODE BIT

### Examples of Multiplexer Options



### Changing the MUX Assignment “On the Fly”



Tables 1 and 2 show the configurations when COM = 0, and COM = 1.

**Table 1. Channel Configuration (When COM = 0, CH7/COM Pin Is Used as CH7)**

SD	OS	S1	S0	COM	Channel Configuration	
					“+”	“-”
0	0	0	0	0	CH0	CH1
0	0	0	1	0	CH2	CH3
0	0	1	0	0	CH4	CH5
0	0	1	1	0	CH6	CH7
0	1	0	0	0	CH1	CH0
0	1	0	1	0	CH3	CH2
0	1	1	0	0	CH5	CH4
0	1	1	1	0	CH7	CH6
1	0	0	0	0	CH0	GND
1	0	0	1	0	CH2	GND
1	0	1	0	0	CH4	GND
1	0	1	1	0	CH6	GND
1	1	0	0	0	CH1	GND
1	1	0	1	0	CH3	GND
1	1	1	0	0	CH5	GND
1	1	1	1	0	CH7	GND

## APPLICATIONS INFORMATION

**Table 2. Channel Configuration (When COM = 1, CH7/COM Pin Is Used as COMMON)**

SD	OS	S1	S0	COM	CHANNEL CONFIGURATION	
					“+”	“-”
1	0	0	0	1	CH0	CH7/COM
1	0	0	1	1	CH2	CH7/COM
1	0	1	0	1	CH4	CH7/COM
1	0	1	1	1	CH6	CH7/COM
1	1	0	0	1	CH1	CH7/COM
1	1	0	1	1	CH3	CH7/COM
1	1	1	0	1	CH5	CH7/COM

### Driving the Analog Inputs

The analog inputs of the LTC1863L/LTC1867L are easy to drive. Each of the analog inputs can be used as a single-ended input relative to the GND pin (CH0-GND, CH1-GND, etc) or in pairs (CH0 and CH1, CH2 and CH3, CH4 and CH5, CH6 and CH7) for differential inputs. In addition, CH7 can act as a COM pin for both single-ended and differential modes if the COM bit in the input word is high. Regardless of the MUX configuration, the “+” and “-” inputs are sampled at the same instant. Any unwanted signal that is common mode to both inputs will be reduced by the common mode rejection of the sample-and-hold circuit. The inputs draw only one small current spike while charging the sample-and-hold capacitors during the acquire mode. In conversion mode, the analog inputs draw only a small leakage current. If the source impedance of the driving circuit is low then the LTC1863L/LTC1867L inputs can be driven directly. More acquisition time should be allowed for a higher impedance source.

The following list is a summary of the op amps that are suitable for driving the LTC1863L/LTC1867L.

LT<sup>®</sup>1468: 90MHz, 22V/μs 16-bit accurate amplifier

LT1469: Dual LT1468

LT1490A/LT1491A: Dual/quad micropower amplifiers, 50μA/amplifier max, 500μV offset, common mode range extends 44V above V<sup>-</sup> independent of V<sup>+</sup>, 3V, 5V and ±15V supplies.

LT1568: Very low noise, active RC filter building block, cutoff frequency up to 10MHz, 2.7V to ±5V supplies.

LT1638/LT1639: Dual/quad 1.2MHz, 0.4V/μs amplifiers, 230μA per amplifier, 3V, 5V and ±15V supplies.

LT1881/LT1882: Dual and quad, 200pA bias current, rail-to-rail output op amps, up to ±15V supplies.

LTC1992-2: Gain of 2 fully differential input/output amplifier/driver, 2.5mV offset, C<sub>LOAD</sub> stable, 2.7V to ±5V supplies.

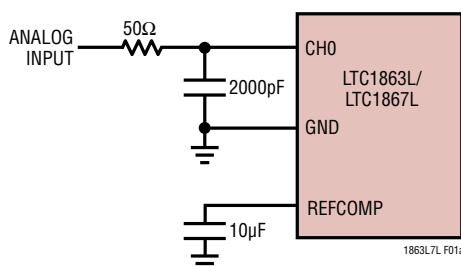
LT1995: 30MHz, 1000V/μs gain selectable amplifier, pin configurable as a difference amplifier, inverting and non-inverting amplifier, ±2.5V to ±15V supplies.

LTC6912: Dual programmable gain amplifiers with SPI serial interface, 2mV offset, 2.7V to ±5V supplies.

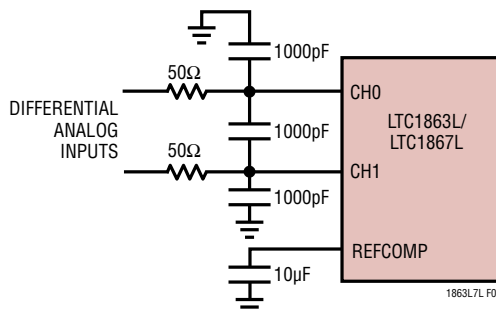
LTC6915: Zero drift, instrumentation amplifier with SPI programmable gain, 125dB CMRR, 0.1% gain accuracy, 10μV offset.

### Input Filtering

The noise and the distortion of the input amplifier and other circuitry must be considered since they will add to the LTC1863L/LTC1867L noise and distortion. Noisy input circuitry should be filtered prior to the analog inputs to minimize noise. A simple 1-pole RC filter is sufficient



**Figure 1a. Optional RC Input Filtering for Single-Ended Input**



**Figure 1b. Optional RC Input Filtering for Differential Inputs**

1863L7Ifc

## APPLICATIONS INFORMATION

for many applications. For instance, Figure 1 shows a 50Ω source resistor and a 2000pF capacitor to ground on the input will limit the input bandwidth to 1.6MHz. The source impedance has to be kept low to avoid gain error and degradation in the AC performance. The capacitor also acts as a charge reservoir for the input sample-and-hold and isolates the ADC input from sampling glitch sensitive circuitry. High quality capacitors and resistors should be used since these components can add distortion. NPO and silver mica type dielectric capacitors have excellent linearity. Carbon surface mount resistors can also generate distortion from self heating and from damage that may occur during soldering. Metal film surface mount resistors are much less susceptible to both problems.

### DC Performance

One way of measuring the transition noise associated with a high resolution ADC is to use a technique where a DC signal is applied to the input of the ADC and the resulting output codes are collected over a large number of conversions. For example, in Figure 2 the distribution of output codes is shown for a DC input that had been digitized 4096 times. The distribution is Gaussian and the RMS code transition noise is about 1.6LSB.

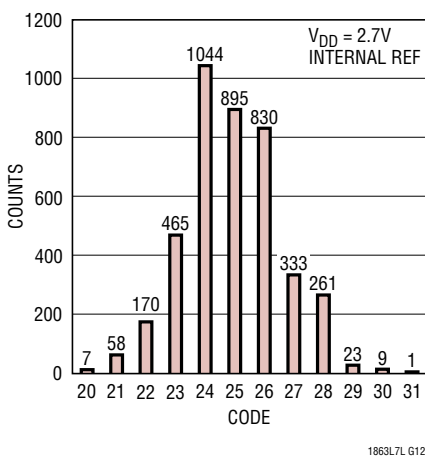


Figure 2. LTC1867L Histogram for 4096 Conversions

### Dynamic Performance

FFT (Fast Fourier Transform) test techniques are used to test the ADC's frequency response, distortion and noise at the rated throughput. By applying a low distortion sine wave and analyzing the digital output using an FFT

algorithm, the ADC's spectral content can be examined for frequencies outside the fundamental.

### Signal-to-Noise Ratio

The Signal-to-Noise and Distortion Ratio (SINAD) is the ratio between the RMS amplitude of the fundamental input frequency to the RMS amplitude of all other frequency components at the A/D output. The output is band limited to frequencies from above DC and below half the sampling frequency. Figure 3a shows a typical SINAD of 81.4dB with a 175kHz sampling rate and a 1kHz input. Higher SINAD can be obtained with a 3V supply. For example, when an external 3V is applied to REFCOMP (tie  $V_{REF}$  to GND), a SINAD of 83.5dB can be achieved as shown in Figure 3b.

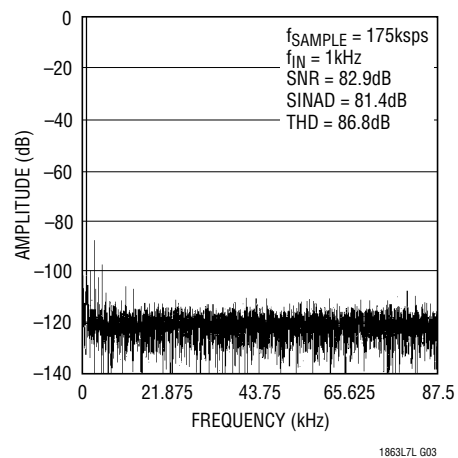


Figure 3a. LTC1867L Nonaveraged 4096 Point FFT Plot with 2.7V Supply

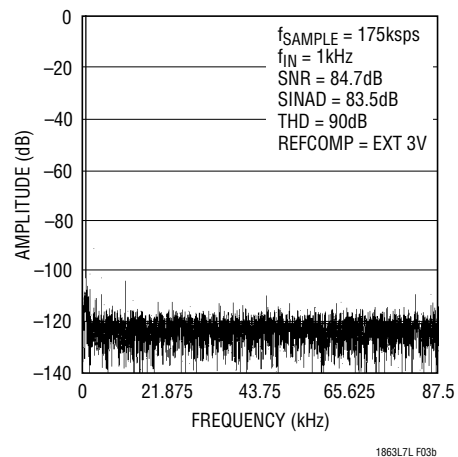


Figure 3b. LTC1867L Nonaveraged 4096 Point FFT Plot with 3V Supply

## APPLICATIONS INFORMATION

### Total Harmonic Distortion

Total Harmonic Distortion (THD) is the ratio of the RMS sum of all harmonics of the input signal to the fundamental itself. The out-of-band harmonics alias into the frequency band between DC and half the sampling frequency. THD is expressed as:

$$THD = 20 \log \frac{\sqrt{V_2^2 + V_3^2 + V_4^2 \dots + V_N^2}}{V_1}$$

where  $V_1$  is the RMS amplitude of the fundamental frequency and  $V_2$  through  $V_N$  are the amplitudes of the second through Nth harmonics.

### Internal Reference

The LTC1863L and LTC1867L have an on-chip, temperature compensated, curvature corrected, bandgap reference that is factory trimmed to 1.25V. It is internally connected to a reference amplifier and is available at  $V_{REF}$  (Pin 10). A 3k resistor is in series with the output so that it can be easily overdriven by an external reference if better drift and/or accuracy are required as shown in Figure 4. The reference amplifier gains the  $V_{REF}$  voltage by 2x to 2.5V at REFCOMP (Pin 9). This reference amplifier

compensation pin, REFCOMP, must be bypassed with a 10 $\mu$ F ceramic or tantalum in parallel with a 0.1 $\mu$ F ceramic for best noise performance.

### Digital Interface

The LTC1863L and LTC1867L have a very simple digital interface that is enabled by the control input,  $\overline{CS}/CONV$ . A logic rising edge applied to the  $\overline{CS}/CONV$  input will initiate a conversion. After the conversion, taking  $\overline{CS}/CONV$  low will enable the serial port and the ADC will present digital data in two's complement format in bipolar mode or straight binary format in unipolar mode, through the SCK/SDO serial port.

### Internal Clock

The internal clock is factory trimmed to achieve a typical conversion time of 3.2 $\mu$ s and a maximum conversion time, 3.7 $\mu$ s, over the full operating temperature range. The typical acquisition time is 1.68 $\mu$ s, and a throughput sampling rate of 175ksps is tested and guaranteed.

### Automatic Nap Mode

The LTC1863L and LTC1867L go into automatic nap mode when  $\overline{CS}/CONV$  is held high after the conversion is complete. With a typical operating current of 750 $\mu$ A and automatic 170 $\mu$ A nap mode between conversions, the power dissipation drops with reduced sample rate. The ADC only keeps the  $V_{REF}$  and REFCOMP voltages active when the part is in the automatic nap mode. The slower the sample rate allows the power dissipation to be lower (see Figure 5).

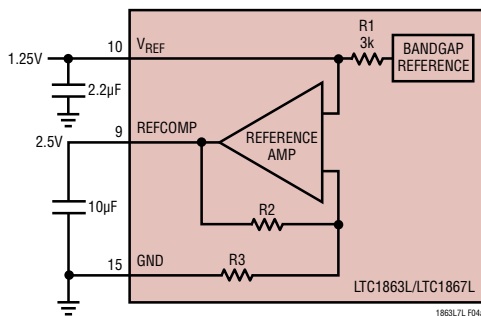


Figure 4a. LTC1867L Reference Circuit

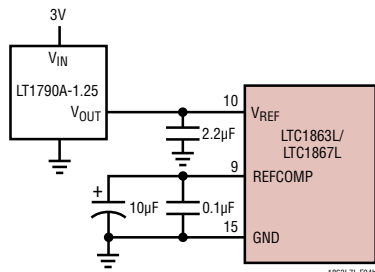


Figure 4b. Using the LT1790A-1.25 as an External Reference

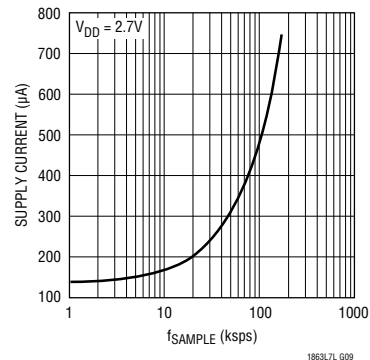


Figure 5. Supply Current vs  $f_{SAMPLE}$

## APPLICATIONS INFORMATION

If the  $\overline{\text{CS/CONV}}$  returns low during a bit decision, it can create a small error. For best performance ensure that the  $\overline{\text{CS/CONV}}$  returns low either within 100ns after the conversion starts (i.e. before the first bit decision) or after the conversion ends. If  $\overline{\text{CS/CONV}}$  is low when the conversion ends, the MSB bit will appear on SDO at the end of the conversion and the ADC will remain powered up.

### Sleep Mode

If the  $\text{SLP} = 1$  is selected in the input word, the ADC will enter SLEEP mode and draw only leakage current (provided that all the digital inputs stay at GND or  $V_{\text{DD}}$ ). After release from the SLEEP mode, the ADC needs 80ms to wake up (charge the  $2.2\mu\text{F}/10\mu\text{F}$  bypass capacitors on  $V_{\text{REF}}/\text{REFCOMP}$  pins).

### Board Layout and Bypassing

To obtain the best performance, a printed circuit board with a ground plane is required. Layout for the printed circuit board should ensure digital and analog signal lines are separated as much as possible. In particular, care should be taken not to run any digital signal alongside an analog signal.

All analog inputs should be screened by GND.  $V_{\text{REF}}$ ,  $\text{REFCOMP}$  and  $V_{\text{DD}}$  should be bypassed to this ground plane as close to the pin as possible; the low impedance of the common return for these bypass capacitors is essential to the low noise operation of the ADC. The width for these tracks should be as wide as possible.

### Timing and Control

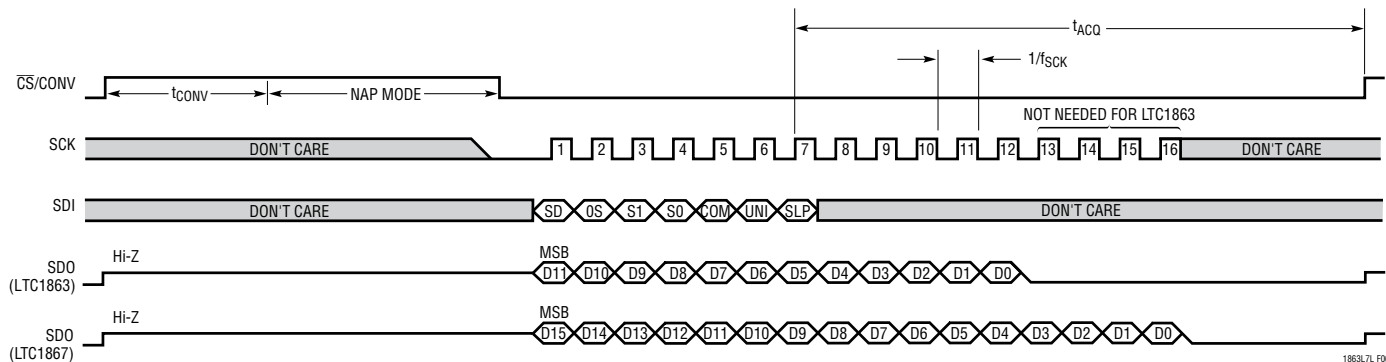
Conversion start is controlled by the  $\overline{\text{CS/CONV}}$  digital input. The rising edge transition of the  $\overline{\text{CS/CONV}}$  will start a conversion. Once initiated, it cannot be restarted until the conversion is complete. Figures 6 and 7 show the timing diagrams for two types of  $\overline{\text{CS/CONV}}$  pulses.

Example 1 (Figure 6) shows the LTC1863L/LTC1867L operating in automatic nap mode with  $\overline{\text{CS/CONV}}$  signal staying HIGH after the conversion. Automatic nap mode provides power reduction at reduced sample rate.

The ADCs can also operate with the  $\overline{\text{CS/CONV}}$  signal returning LOW before the conversion ends. In this mode (Example 2, Figure 7), the ADCs remain powered up. The digital output, SDO, will go HIGH immediately after the conversion is complete if the analog inputs are above half scale in unipolar mode or below half scale in bipolar mode. This is a way to measure the conversion time of the A/D converter.

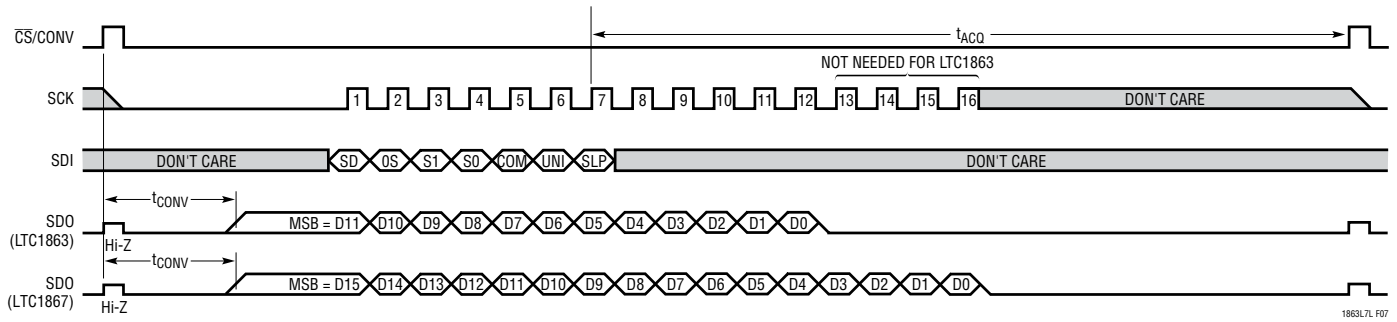
For best performance, it is recommended to keep SCK, SDI, and SDO at a constant logic high or low during acquisition and conversion, even though these signals may be ignored by the serial interface (DON'T CARE). Communication with other devices on the bus should not coincide with the conversion period ( $t_{\text{CONV}}$ ).

Figures 8 and 9 are the transfer characteristics for the bipolar and unipolar mode.

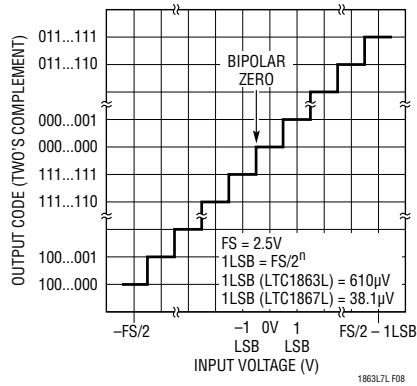


**Figure 6. Example 1,  $\overline{\text{CS/CONV}}$  Starts a Conversion and Remains HIGH Until Next Data Transfer. With  $\overline{\text{CS/CONV}}$  Remaining HIGH After the Conversion, Automatic Nap Modes Provides Power Reduction at Reduced Sample Rate**

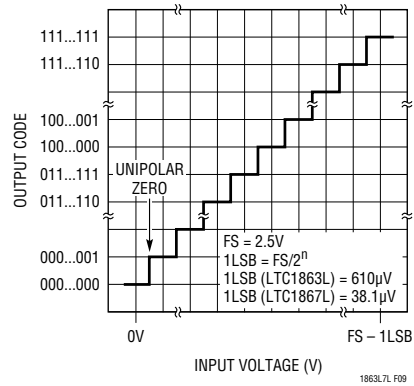
## APPLICATIONS INFORMATION



**Figure 7. Example 2,  $\overline{\text{CS/CONV}}$  Starts a Conversion With Short Active HIGH Pulse. With  $\overline{\text{CS/CONV}}$  Returning LOW Before the Conversion, the ADC Remains Powered Up**



**Figure 8. LTC1863L/LTC1867L Bipolar Transfer Characteristics (Two's Complement)**

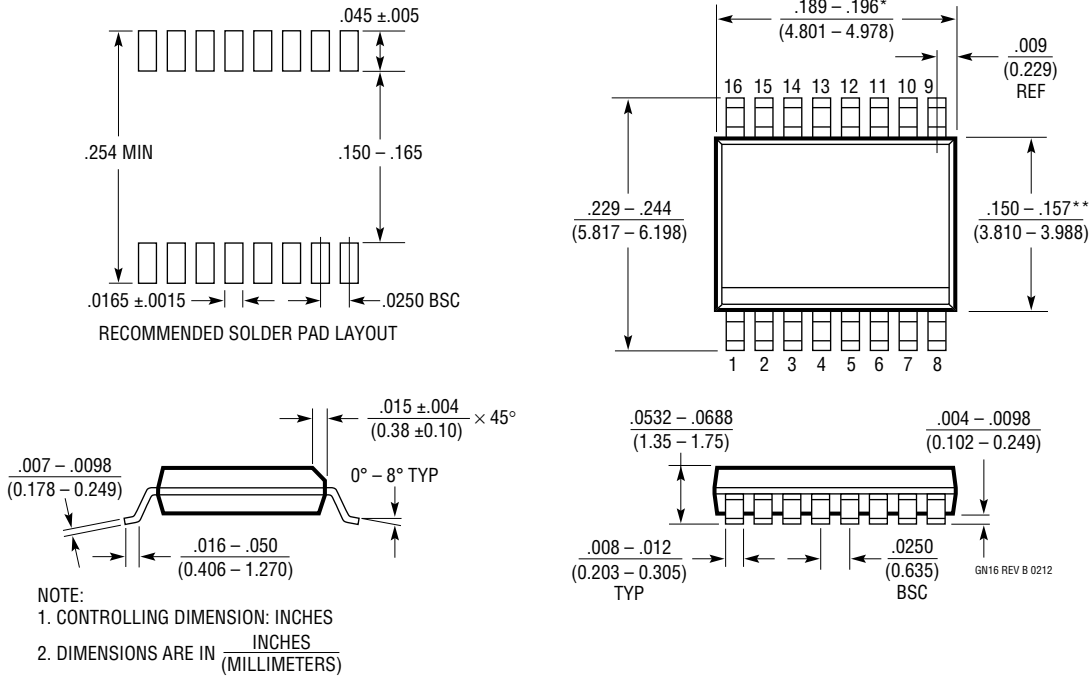


**Figure 9. LTC1863L/LTC1867L Unipolar Transfer Characteristics (Straight Binary)**

# PACKAGE DESCRIPTION

Please refer to <http://www.linear.com/product/LTC1863L#packaging> for the most recent package drawings.

## GN Package 16-Lead Plastic SSOP (Narrow .150 Inch) (Reference LTC DWG # 05-08-1641 Rev B)



# REVISION HISTORY

REV	DATE	DESCRIPTION	PAGE NUMBER
B	6/14	Fixed the Order Information.	2
C	5/15	Adjusted Notes 3 and 4 to specify input currents up to 100mA.	4, 5
E	2/18	Added text to V <sub>DD</sub> pin functions	7

## RELATED PARTS

PART NUMBER	DESCRIPTION	COMMENTS
<a href="#">LTC1417</a>	14-Bit, 400ksps Serial ADC	20mW, Unipolar or Bipolar, Internal Reference, SSOP-16 Package
<a href="#">LT1468/LT1469</a>	Single/Dual 90MHz, 22V/μs, 16-Bit Accurate Op Amps	Low Input Offset: 75μV/125μV
<a href="#">LTC1609</a>	16-Bit, 200ksps Serial ADC	65mW, Configurable Bipolar and Unipolar Input Ranges, 5V Supply
<a href="#">LT1790A</a>	Micropower Precision Series Reference	Bandgap, 60μA Max Supply Current, 10ppm/°C, SOT-23 Package
<a href="#">LTC1850/LTC1851</a>	10-Bit/12-Bit, 8-Channel, 1.25Msps ADC	Parallel Output, Programmable MUX and Sequencer, 5V Supply
<a href="#">LTC1852/LTC1853</a>	10-Bit/12-Bit, 8-Channel, 400ksps ADC	Parallel Output, Programmable MUX and Sequencer, 3V or 5V Supply
<a href="#">LTC1860/LTC1861</a>	12-Bit, 1-/2-Channel 250ksps ADC in MSOP	850μA at 250ksps, 2μA at 1ksps, SO-8 and MSOP Packages
<a href="#">LTC1860L/LTC1861L</a>	3V, 12-Bit, 1-/2-Channel 150ksps ADC	450μA at 150ksps, 10μA at 1ksps, SO-8 and MSOP Packages
<a href="#">LTC1863/LTC1867</a>	12-/16-Bit, 8-Channel 200ksps ADC	5V Supply, Pin Compatible with LTC1863L/LTC1867L
<a href="#">LTC1864/LTC1865</a>	16-Bit, 1-/2-Channel 250ksps ADC in MSOP	850μA at 250ksps, 2μA at 1ksps, SO-8 and MSOP Packages
<a href="#">LTC1864L/LTC1865L</a>	3V, 16-Bit, 1-/2-Channel 150ksps ADC in MSOP	450μA at 150ksps, 10μA at 1ksps, SO-8 and MSOP Packages



# Mouser Electronics

Authorized Distributor

Click to View Pricing, Inventory, Delivery & Lifecycle Information:

## [Analog Devices Inc.:](#)

[LTC1863LCGN#PBF](#) [LTC1867LCGN#PBF](#) [LTC1863LIGN](#) [LTC1863LIGN#TR](#) [LTC1867LIGN#PBF](#) [LTC1867LAIGN](#)  
[LTC1867LIGN#TR](#) [LTC1867LCGN#TRPBF](#) [LTC1867LIGN#TRPBF](#) [LTC1863LCGN#TR](#) [LTC1867LCGN#TR](#)  
[LTC1867LACGN#PBF](#) [LTC1867LACGN#TR](#) [LTC1867LACGN#TRPBF](#) [LTC1863LIGN#TRPBF](#)  
[LTC1867LAIGN#TRPBF](#) [LTC1863LCGN](#) [LTC1863LCGN#TRPBF](#) [LTC1867LACGN](#) [LTC1867LCGN](#)  
[LTC1867LAIGN#TR](#) [LTC1863LIGN#PBF](#) [LTC1867LIGN](#) [LTC1867LAIGN#PBF](#)