



Film Capacitors

Metallized Polypropylene Film Capacitors (MFP)

Series/Type: B32686S

Date: June 2018

© EPCOS AG 2018. Reproduction, publication and dissemination of this publication, enclosures hereto and the information contained therein without EPCOS' prior express consent is prohibited.

EPCOS AG is a TDK Group Company.

Snubber**Typical applications**

- Snubbing
- Filtering
- IGBT

Climatic

- Max. operating temperature: 110 °C
- Climatic category (IEC 60068-1:2013): 55/100/56

Construction

- Dielectric: polypropylene (PP)
- Film metallized on one side and metal foils internally connected in series
- Plastic case, epoxy resin sealing (UL 94 V-0)

Features

- Very high pulse strength
- High current
- Highest possible contact reliability
- RoHS-compatible

Terminals

- Strap terminals, tinned copper (max. torque 10 Nm)

Marking

Manufacturer's logo, ordering code, style (MFP)
rated capacitance (coded), cap. tolerance (code letter),
rated DC voltage, date of manufacture (coded)

Delivery mode: Bulk (untaped)

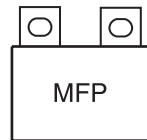

Dimensional drawings

T1 (code no. 561)

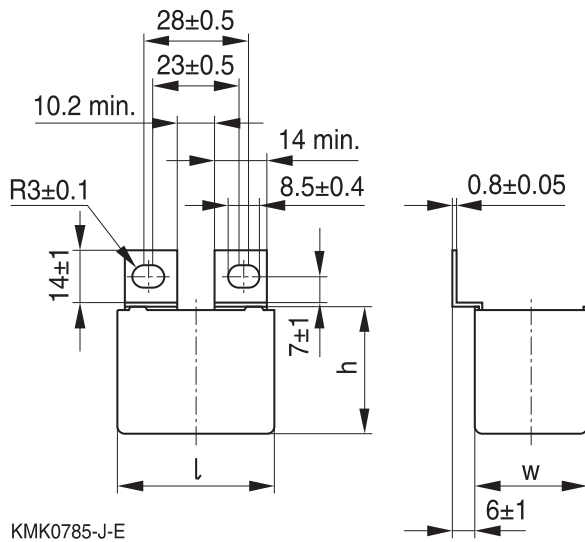

T2 (code no. 562)

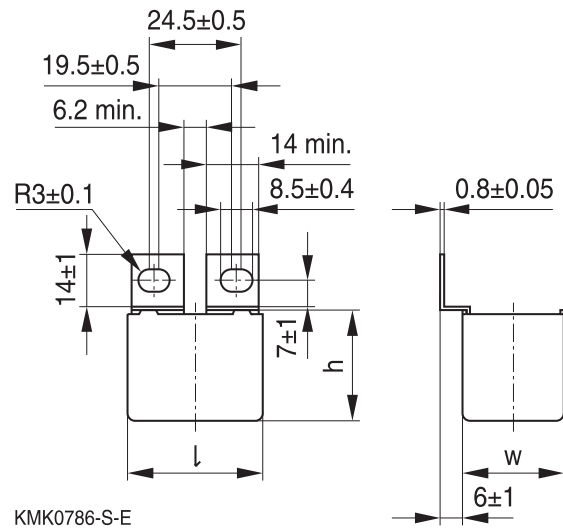

T3 (code no. 563)

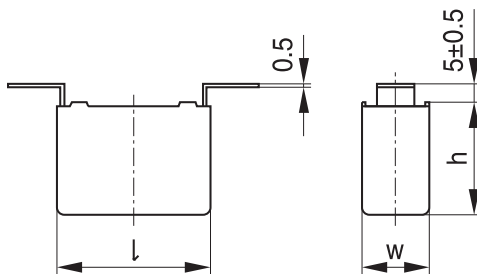

T4 (code no. 564)

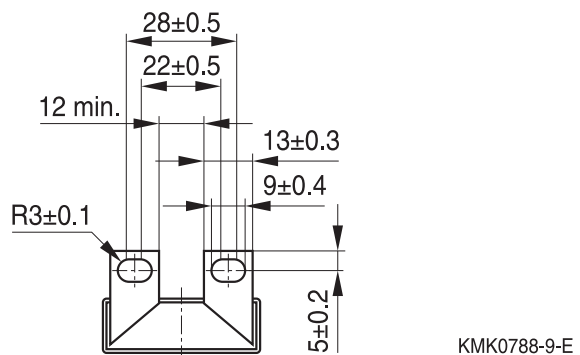
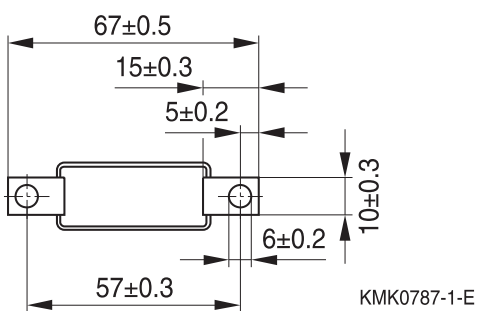
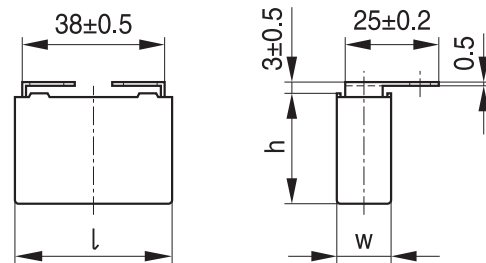

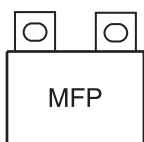

B32686S

Snubber

Dimensional drawings (continued)

T5 (code no. 565)

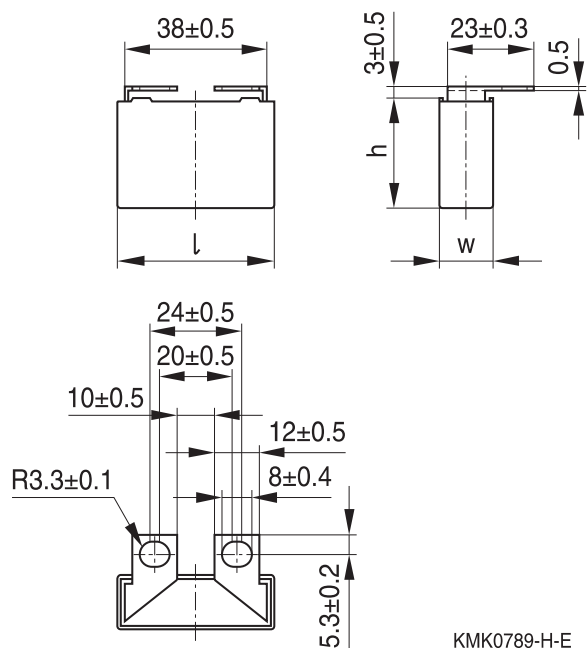

T6 (code no. 566)

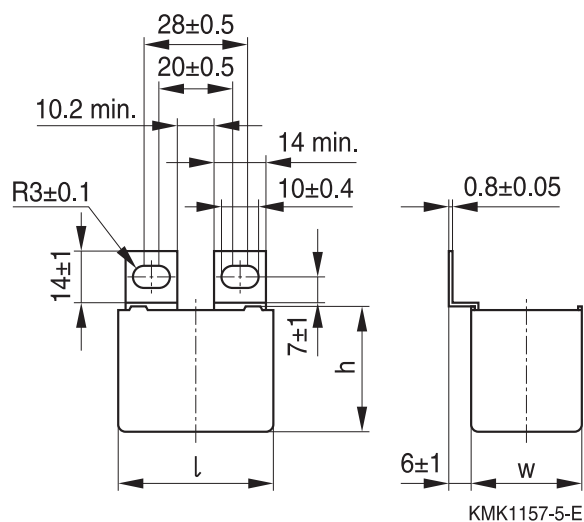

Overview of available types

Type	B32686S			
V_R (V DC)	1000	1250	1600	2000
V_{RMS} (V AC)	400	450	450	500
C_R (nF)				
22				
33				
47				
68				
100				
120				
150				
220				
270				
330				
390				
470				
560				
680				

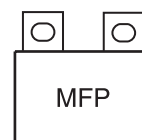
Ordering codes and packing units

V_R	V_{RMS} $f \leq 1\text{kHz}$	C_R	Max. dimensions $w \times h \times l$	I_{RMS} 100 kHz	ESR 100 kHz	Ordering code (composition see below)	Ter- minal	pcs./ MOQ
V DC	V AC	nF	mm	A	m Ω			
1000	400	68	12.0 × 22.5 × 42.0	4.0	20	B32686S0683+563	T3	224
		68	12.0 × 22.5 × 42.0	4.0	20	B32686S0683+564	T4	384
		100	12.0 × 22.5 × 42.0	4.5	15	B32686S0104+563	T3	224
		100	12.0 × 22.5 × 42.0	4.5	15	B32686S0104+564	T4	384
		120	12.0 × 22.5 × 42.0	4.5	13	B32686S0124+563	T3	224
		120	12.0 × 22.5 × 42.0	4.5	13	B32686S0124+564	T4	384
		150	14.0 × 25.0 × 42.0	5.5	10	B32686S0154+563	T3	192
		150	14.0 × 25.0 × 42.0	5.5	10	B32686S0154+564	T4	288
		150	14.0 × 25.0 × 42.0	5.5	10	B32686S0154+565	T5	288
		220	16.0 × 28.5 × 42.0	7.0	7	B32686S0224+563	T3	160
		220	16.0 × 28.5 × 42.0	7.0	7	B32686S0224+564	T4	192
		220	16.0 × 28.5 × 42.0	7.0	7	B32686S0224+565	T5	192
		270	18.0 × 32.5 × 42.0	7.5	7	B32686S0274+563	T3	144
		270	18.0 × 32.5 × 42.0	7.5	7	B32686S0274+564	T4	128
		270	18.0 × 32.5 × 42.0	7.5	7	B32686S0274+565	T5	128
		330	20.0 × 39.5 × 42.0	8.5	5	B32686S0334+561	T1	96
		330	20.0 × 39.5 × 42.0	8.5	5	B32686S0334+562	T2	96
		330	20.0 × 39.5 × 42.0	8.5	5	B32686S0334+563	T3	104
		330	20.0 × 39.5 × 42.0	8.5	5	B32686S0334+564	T4	96
		330	20.0 × 39.5 × 42.0	8.5	5	B32686S0334+565	T5	96
		330	20.0 × 39.5 × 42.0	8.5	5	B32686S0334+566	T6	96
		390	20.0 × 39.5 × 42.0	9.0	5	B32686S0394+561	T1	96
		390	20.0 × 39.5 × 42.0	9.0	5	B32686S0394+562	T2	96
		390	20.0 × 39.5 × 42.0	9.0	5	B32686S0394+563	T3	104
		390	20.0 × 39.5 × 42.0	9.0	5	B32686S0394+564	T4	96
		390	20.0 × 39.5 × 42.0	9.0	5	B32686S0394+565	T5	96
		390	20.0 × 39.5 × 42.0	9.0	5	B32686S0394+566	T6	96
		470	28.0 × 37.0 × 42.0	10.0	3	B32686S0474+561	T1	108
		470	28.0 × 37.0 × 42.0	10.0	3	B32686S0474+562	T2	108
		470	28.0 × 37.0 × 42.0	10.0	3	B32686S0474+563	T3	72
		470	28.0 × 37.0 × 42.0	10.0	3	B32686S0474+566	T6	108

MOQ = Minimum Order Quantity, consisting of 4 packing units.

Further E series and intermediate capacitance values on request.

Composition of ordering code

+ = Capacitance tolerance code:

K = $\pm 10\%$

J = $\pm 5\%$

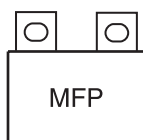

B32686S

Snubber

Ordering codes and packing units

V_R	V_{RMS} $f \leq 1\text{kHz}$	C_R	Max. dimensions $w \times h \times l$	I_{RMS} 100 kHz	ESR 100 kHz	Ordering code (composition see below)	Ter- minal	pcs./ MOQ
V DC	V AC	nF	mm	A	$m\Omega$			
1000	400	560	28.0 × 37.0 × 42.0	11.0	3	B32686S0564+561	T1	108
		560	28.0 × 37.0 × 42.0	11.0	3	B32686S0564+562	T2	108
		560	28.0 × 37.0 × 42.0	11.0	3	B32686S0564+563	T3	72
		560	28.0 × 37.0 × 42.0	11.0	3	B32686S0564+566	T6	108
		680	30.0 × 45.0 × 42.0	12.0	3	B32686S0684+561	T1	48
		680	30.0 × 45.0 × 42.0	12.0	3	B32686S0684+562	T2	48
		680	30.0 × 45.0 × 42.0	12.0	3	B32686S0684+563	T3	72
		680	30.0 × 45.0 × 42.0	12.0	3	B32686S0684+566	T6	48
1250	450	68	12.0 × 22.5 × 42.0	4.5	20	B32686S7683+563	T3	224
		68	12.0 × 22.5 × 42.0	4.5	20	B32686S7683+564	T4	384
		100	14.0 × 25.0 × 42.0	5.0	15	B32686S7104+563	T3	192
		100	14.0 × 25.0 × 42.0	5.0	15	B32686S7104+564	T4	288
		100	14.0 × 25.0 × 42.0	5.0	15	B32686S7104+565	T5	288
		120	14.0 × 25.0 × 42.0	5.5	13	B32686S7124+563	T3	192
		120	14.0 × 25.0 × 42.0	5.5	13	B32686S7124+564	T4	288
		120	14.0 × 25.0 × 42.0	5.5	13	B32686S7124+565	T5	288
		150	16.0 × 28.5 × 42.0	6.5	10	B32686S7154+563	T3	160
		150	16.0 × 28.5 × 42.0	6.5	10	B32686S7154+564	T4	192
		150	16.0 × 28.5 × 42.0	6.5	10	B32686S7154+565	T5	192
		220	18.0 × 32.5 × 42.0	8.5	7	B32686S7224+563	T3	144
		220	18.0 × 32.5 × 42.0	8.5	7	B32686S7224+564	T4	128
		220	18.0 × 32.5 × 42.0	8.5	7	B32686S7224+565	T5	128
		270	20.0 × 39.5 × 42.0	9.0	7	B32686S7274+561	T1	96
		270	20.0 × 39.5 × 42.0	9.0	7	B32686S7274+562	T2	96
		270	20.0 × 39.5 × 42.0	9.0	7	B32686S7274+563	T3	104
		270	20.0 × 39.5 × 42.0	9.0	7	B32686S7274+564	T4	96
		270	20.0 × 39.5 × 42.0	9.0	7	B32686S7274+565	T5	96
		270	20.0 × 39.5 × 42.0	9.0	7	B32686S7274+566	T6	96
330	28.0 × 37.0 × 42.0	10.0	5	B32686S7334+561	T1	108		
330	28.0 × 37.0 × 42.0	10.0	5	B32686S7334+562	T2	108		
330	28.0 × 37.0 × 42.0	10.0	5	B32686S7334+563	T3	72		
330	28.0 × 37.0 × 42.0	10.0	5	B32686S7334+566	T6	108		

MOQ = Minimum Order Quantity, consisting of 4 packing units.
Further E series and intermediate capacitance values on request.

Composition of ordering code

+ = Capacitance tolerance code:

K = ±10%

J = ±5%

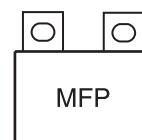
Ordering codes and packing units

V_R	V_{RMS} $f \leq 1\text{kHz}$	C_R	Max. dimensions $w \times h \times l$	I_{RMS} 100 kHz	ESR 100 kHz	Ordering code (composition see below)	Ter- minal	pcs./ MOQ
V DC	V AC	nF	mm	A	m Ω			
1250	450	390	28.0 × 37.0 × 42.0	11.0	5	B32686S7394+561	T1	108
		390	28.0 × 37.0 × 42.0	11.0	5	B32686S7394+562	T2	108
		390	28.0 × 37.0 × 42.0	11.0	5	B32686S7394+563	T3	72
		390	28.0 × 37.0 × 42.0	11.0	5	B32686S7394+566	T6	108
		470	30.0 × 45.0 × 42.0	12.0	5	B32686S7474+561	T1	48
		470	30.0 × 45.0 × 42.0	12.0	5	B32686S7474+562	T2	48
		470	30.0 × 45.0 × 42.0	12.0	5	B32686S7474+563	T3	72
		470	30.0 × 45.0 × 42.0	12.0	5	B32686S7474+566	T6	48
1600	450	47	12.0 × 22.5 × 42.0	5.0	30	B32686S1473+563	T3	224
		47	12.0 × 22.5 × 42.0	5.0	30	B32686S1473+564	T4	384
		68	14.0 × 25.0 × 42.0	6.0	20	B32686S1683+563	T3	192
		68	14.0 × 25.0 × 42.0	6.0	20	B32686S1683+564	T4	288
		68	14.0 × 25.0 × 42.0	6.0	20	B32686S1683+565	T5	288
		100	18.0 × 32.5 × 42.0	7.0	15	B32686S1104+563	T3	144
		100	18.0 × 32.5 × 42.0	7.0	15	B32686S1104+564	T4	128
		100	18.0 × 32.5 × 42.0	7.0	15	B32686S1104+565	T5	128
		120	18.0 × 32.5 × 42.0	7.5	13	B32686S1124+563	T3	144
		120	18.0 × 32.5 × 42.0	7.5	13	B32686S1124+564	T4	128
		120	18.0 × 32.5 × 42.0	7.5	13	B32686S1124+565	T5	128
		150	20.0 × 39.5 × 42.0	8.5	10	B32686S1154+561	T1	96
		150	20.0 × 39.5 × 42.0	8.5	10	B32686S1154+562	T2	96
		150	20.0 × 39.5 × 42.0	8.5	10	B32686S1154+563	T3	104
		150	20.0 × 39.5 × 42.0	8.5	10	B32686S1154+564	T4	96
		150	20.0 × 39.5 × 42.0	8.5	10	B32686S1154+565	T5	96
		150	20.0 × 39.5 × 42.0	8.5	10	B32686S1154+566	T6	96
		220	28.0 × 37.0 × 42.0	10.5	7	B32686S1224+561	T1	108
		220	28.0 × 37.0 × 42.0	10.5	7	B32686S1224+562	T2	108
		220	28.0 × 37.0 × 42.0	10.5	7	B32686S1224+563	T3	72
220	28.0 × 37.0 × 42.0	10.5	7	B32686S1224+566	T6	108		

MOQ = Minimum Order Quantity, consisting of 4 packing units.
Further E series and intermediate capacitance values on request.

Composition of ordering code

+ = Capacitance tolerance code:

K = $\pm 10\%$

J = $\pm 5\%$

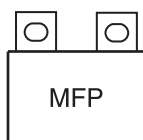

B32686S

Snubber

Ordering codes and packing units

V_R	V_{RMS} $f \leq 1\text{kHz}$	C_R	Max. dimensions $w \times h \times l$	I_{RMS} 100 kHz	ESR 100 kHz	Ordering code (composition see below)	Ter- minal	pcs./ MOQ
V DC	V AC	nF	mm	A	m Ω			
1600	450	270	30.0 × 45.0 × 42.0	11.5	7	B32686S1274+561	T1	48
		270	30.0 × 45.0 × 42.0	11.5	7	B32686S1274+562	T2	48
		270	30.0 × 45.0 × 42.0	11.5	7	B32686S1274+563	T3	72
		270	30.0 × 45.0 × 42.0	11.5	7	B32686S1274+566	T6	48
2000	500	22	12.0 × 22.5 × 42.0	4.0	70	B32686S2223+563	T3	224
		22	12.0 × 22.5 × 42.0	4.0	70	B32686S2223+564	T4	384
		33	14.0 × 25.0 × 42.0	5.0	50	B32686S2333+563	T3	192
		33	14.0 × 25.0 × 42.0	5.0	50	B32686S2333+564	T4	288
		33	14.0 × 25.0 × 42.0	5.0	50	B32686S2333+565	T5	288
		47	16.0 × 28.5 × 42.0	6.0	30	B32686S2473+563	T3	160
		47	16.0 × 28.5 × 42.0	6.0	30	B32686S2473+564	T4	192
		47	16.0 × 28.5 × 42.0	6.0	30	B32686S2473+565	T5	192
		68	18.0 × 32.5 × 42.0	7.5	20	B32686S2683+563	T3	144
		68	18.0 × 32.5 × 42.0	7.5	20	B32686S2683+564	T4	128
		68	18.0 × 32.5 × 42.0	7.5	20	B32686S2683+565	T5	128
		100	20.0 × 39.5 × 42.0	8.5	15	B32686S2104+561	T1	96
		100	20.0 × 39.5 × 42.0	8.5	15	B32686S2104+562	T2	96
		100	20.0 × 39.5 × 42.0	8.5	15	B32686S2104+563	T3	104
		100	20.0 × 39.5 × 42.0	8.5	15	B32686S2104+564	T4	96
		100	20.0 × 39.5 × 42.0	8.5	15	B32686S2104+565	T5	96
		100	20.0 × 39.5 × 42.0	8.5	15	B32686S2104+566	T6	96
		120	28.0 × 37.0 × 42.0	9.0	13	B32686S2124+561	T1	96
		120	28.0 × 37.0 × 42.0	9.0	13	B32686S2124+562	T2	96
		120	28.0 × 37.0 × 42.0	9.0	13	B32686S2124+563	T3	104
		120	28.0 × 37.0 × 42.0	9.0	13	B32686S2124+566	T6	96
		150	28.0 × 37.0 × 42.0	10.0	10	B32686S2154+561	T1	108
		150	28.0 × 37.0 × 42.0	10.0	10	B32686S2154+562	T2	108
		150	28.0 × 37.0 × 42.0	10.0	10	B32686S2154+563	T3	72
150	28.0 × 37.0 × 42.0	10.0	10	B32686S2154+566	T6	108		

MOQ = Minimum Order Quantity, consisting of 4 packing units.
Further E series and intermediate capacitance values on request.

Composition of ordering code

+ = Capacitance tolerance code:

K = $\pm 10\%$

J = $\pm 5\%$

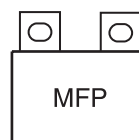
Technical data

Operating temperature range	Max. operating temperature $T_{op,max}$	+110 °C	
	Upper category temperature T_{max}	+100 °C	
	Lower category temperature T_{min}	-55 °C	
	Rated temperature T_R	+85 °C	
Dissipation factor $\tan \delta$ at 20 °C (upper limit values)	1.0 · 10 ⁻³ (at 10 kHz)		
	3.0 · 10 ⁻³ (at 10 kHz)		
Insulation resistance R_{ins} or time constant $\tau = C_R \cdot R_{ins}$ at 20 °C, rel. humidity ≤ 65% (minimum as-delivered values)	$C_R \leq 0.33 \mu F$	$C_R > 0.33 \mu F$	
	100 GΩ	30000 s	
DC test voltage	2.0 · V_R , 2 s		
Category voltage V_C (continuous operation with V_{DC} or V_{AC} at $f \leq 1$ kHz)	T_{op} (°C)	DC voltage derating	AC voltage derating
	$T_{op} \leq 85$ $85 < T_{op} \leq 100$	$V_C = V_R$ $V_C = V_R \cdot (165 - T_{op})/80$	$V_{C,RMS} = V_{RMS}$ $V_{C,RMS} = V_{RMS} \cdot (165 - T_{op})/80$
Operating voltage V_{op} for short operating periods (V_{DC} or V_{AC} at $f \leq 1$ kHz)	T_{op} (°C)	DC voltage (max. hours)	AC voltage (max. hours)
	$T_{op} \leq 85$ $85 < T_{op} \leq 100$	$V_{op} = 1.25 \cdot V_C$ (2000 h) $V_{op} = 1.25 \cdot V_C$ (1000 h)	$V_{op} = 1.0 \cdot V_{C,RMS}$ (2000 h) $V_{op} = 1.0 \cdot V_{C,RMS}$ (1000 h)
Damp heat test	56 days/40 °C/93% relative humidity		
Limit values after damp heat test	Capacitance change $ \Delta C/C $	≤ 2%	
	Dissipation factor change $\Delta \tan \delta$	≤ 1.0 · 10 ⁻³ (at 10 kHz)	
	Insulation resistance R_{ins} or time constant $\tau = C_R \cdot R_{ins}$	≥ 50% of minimum as-delivered values	
Reliability:			
Failure rate λ	1 fit (≤ 1 · 10 ⁻⁹ /h) at 0.5 · V_R , 40 °C		
Service life t_{SL}	200 000 h at 1.0 · V_R , 85 °C		
	For conversion to other operating conditions and temperatures, refer to chapter "Quality, 2 Reliability".		
Failure criteria:			
Total failure	Short circuit or open circuit		
Failure due to variation of parameters	Capacitance change $ \Delta C/C $	> 10%	
	Dissipation factor $\tan \delta$	4 · upper limit value	
	Insulation resistance R_{ins} or time constant $\tau = C_R \cdot R_{ins}$	< 1500 MΩ ($C_R \leq 0.33 \mu F$) < 500 s ($C_R > 0.33 \mu F$)	

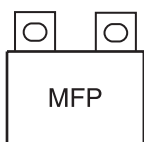

B32686S

Snubber

Pulse handling capability

"dV/dt" represents the maximum permissible voltage change per unit of time for non-sinusoidal voltages, expressed in V/μs.

"k₀" represents the maximum permissible pulse characteristic of the waveform applied to the capacitor, expressed in V²/μs.

Note:

The values of dV/dt and k₀ provided below must not be exceeded in order to avoid damaging the capacitor.

dV/dt and k₀ values

V _R (V DC)	V _{RMS} (V AC)	dV/dt in V/μs	k ₀ in V ² /μs
1000	400	2 000	4 000 000
1250	450	2 800	7 000 000
1600	450	3 500	11 000 000
2000	500	4 500	18 000 000

Impedance Z versus frequency f

(typical values)

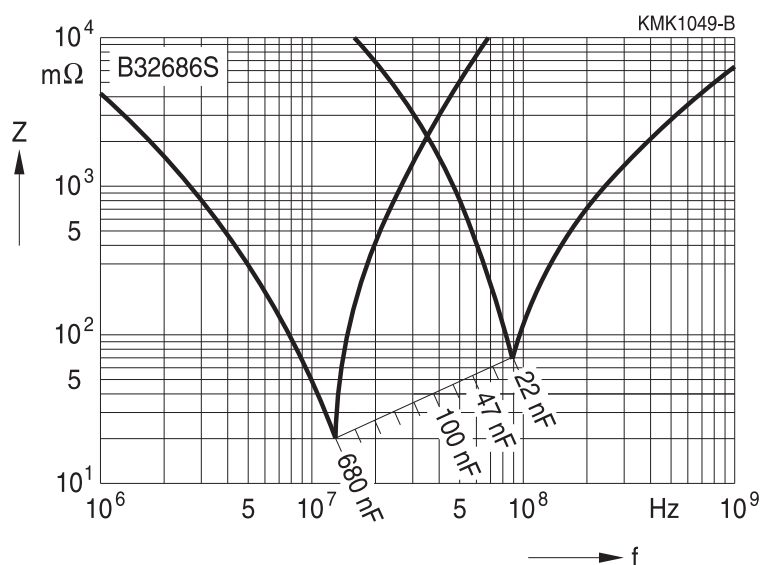

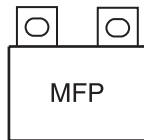
Permissible AC voltage V_{RMS} versus frequency f (for sinusoidal waveforms, $T_A \leq 90^\circ C$)

 For $T_A > 90^\circ C$, please refer to "General technical information", section 3.2.3.

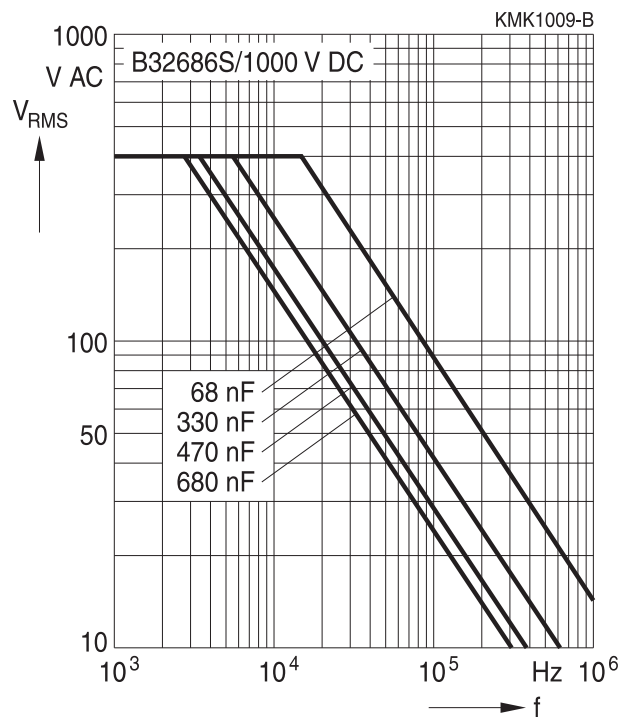
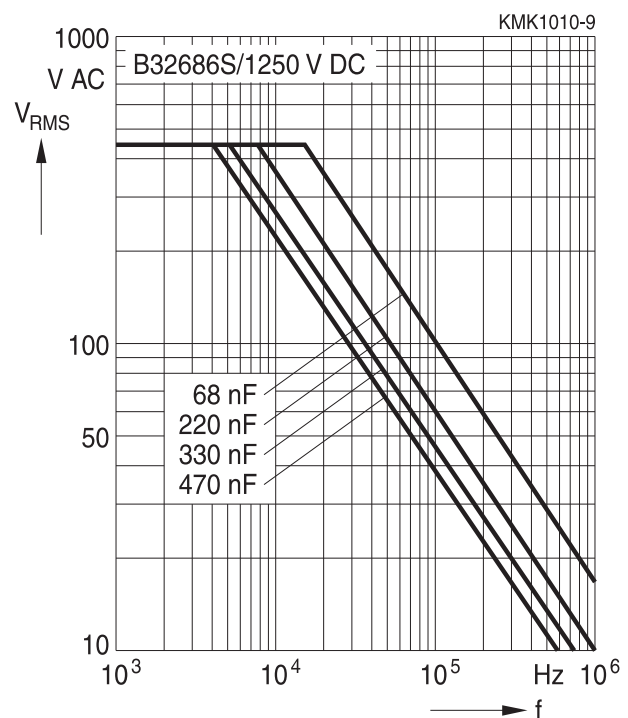
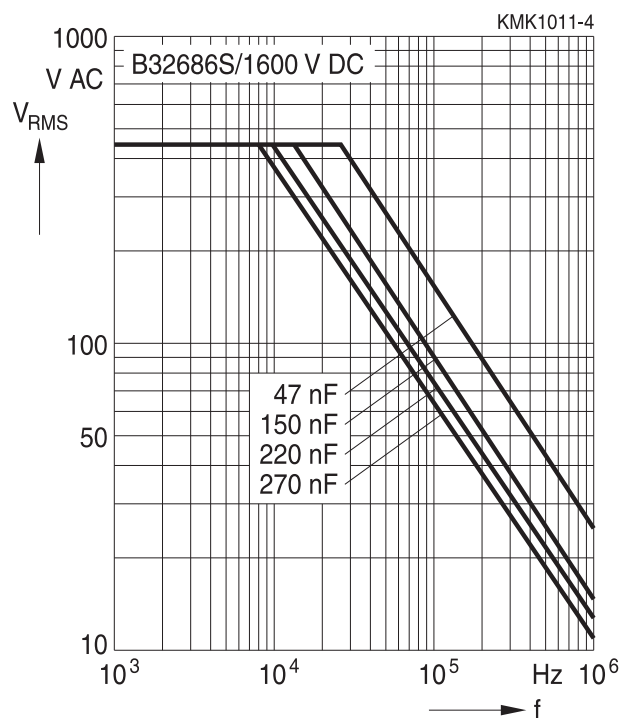
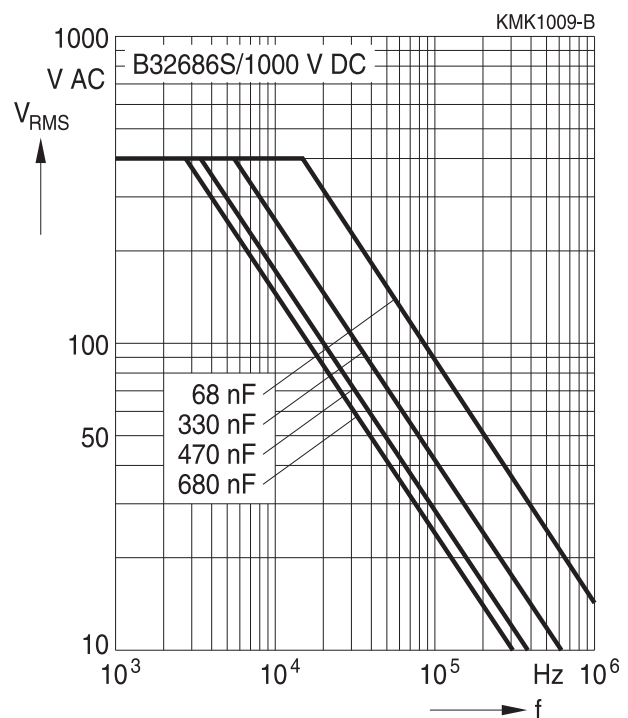
1000 V DC/400 V AC

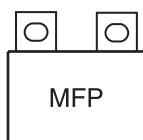
1250 V DC/450 V AC

1600 V DC/450 V AC

2000 V DC/500 V AC



B32686S

Snubber

Mounting guidelines

1 Soldering

1.1 Solderability of leads

The solderability of terminal leads is tested to IEC 60068-2-20:2008, test Ta, method 1.

Before a solderability test is carried out, terminals are subjected to accelerated ageing (to IEC 60068-2-2:2007, test Ba: 4 h exposure to dry heat at 155 °C). Since the ageing temperature is far higher than the upper category temperature of the capacitors, the terminal wires should be cut off from the capacitor before the ageing procedure to prevent the solderability being impaired by the products of any capacitor decomposition that might occur.

Solder bath temperature	235 ±5 °C
Soldering time	2.0 ±0.5 s
Immersion depth	2.0 +0/−0.5 mm from capacitor body or seating plane
Evaluation criteria: Visual inspection	Wetting of wire surface by new solder ≥90%, free-flowing solder

1.2 Resistance to soldering heat

Resistance to soldering heat is tested to IEC 60068-2-20:2008, test Tb, method 1.

Conditions:

Series	Solder bath temperature	Soldering time
MKT boxed (except 2.5 × 6.5 × 7.2 mm) coated uncoated (lead spacing >10 mm)	260 ±5 °C	10 ±1 s
MFP MKP (lead spacing >7.5 mm)		
MKT boxed (case 2.5 × 6.5 × 7.2 mm)		5 ±1 s
MKP (lead spacing ≤7.5 mm)		<4 s
MKT uncoated (lead spacing ≤10 mm) insulated (B32559)		recommended soldering profile for MKT uncoated (lead spacing ≤ 10 mm) and insulated (B32559)

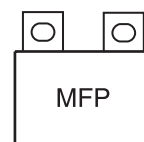

B32686S

Snubber



Immersion depth	2.0 +0/−0.5 mm from capacitor body or seating plane
Shield	Heat-absorbing board, (1.5 ±0.5) mm thick, between capacitor body and liquid solder
Evaluation criteria:	
Visual inspection	No visible damage
$\Delta C/C_0$	2% for MKT/MKP/MFP 5% for EMI suppression capacitors
$\tan \delta$	As specified in sectional specification

1.3 General notes on soldering

Permissible heat exposure loads on film capacitors are primarily characterized by the upper category temperature T_{max} . Long exposure to temperatures above this type-related temperature limit can lead to changes in the plastic dielectric and thus change irreversibly a capacitor's electrical characteristics. For short exposures (as in practical soldering processes) the heat load (and thus the possible effects on a capacitor) will also depend on other factors like:

- Pre-heating temperature and time
- Forced cooling immediately after soldering
- Terminal characteristics:
diameter, length, thermal resistance, special configurations (e.g. crimping)
- Height of capacitor above solder bath
- Shadowing by neighboring components
- Additional heating due to heat dissipation by neighboring components
- Use of solder-resist coatings

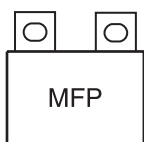

B32686S

Snubber

The overheating associated with some of these factors can usually be reduced by suitable countermeasures. For example, if a pre-heating step cannot be avoided, an additional or reinforced cooling process may possibly have to be included.

EPCOS recommendations

As a reference, the recommended wave soldering profile for our film capacitors is as follows:

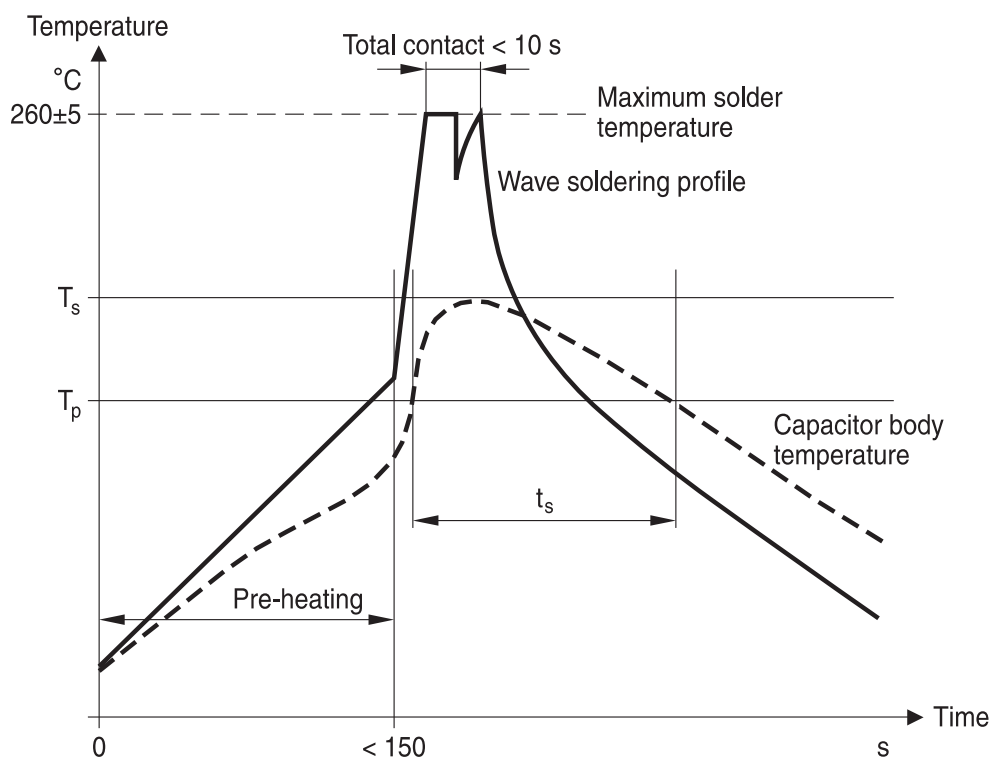

T_s : Capacitor body maximum temperature at wave soldering

T_p : Capacitor body maximum temperature at pre-heating

KMK1745-A-E

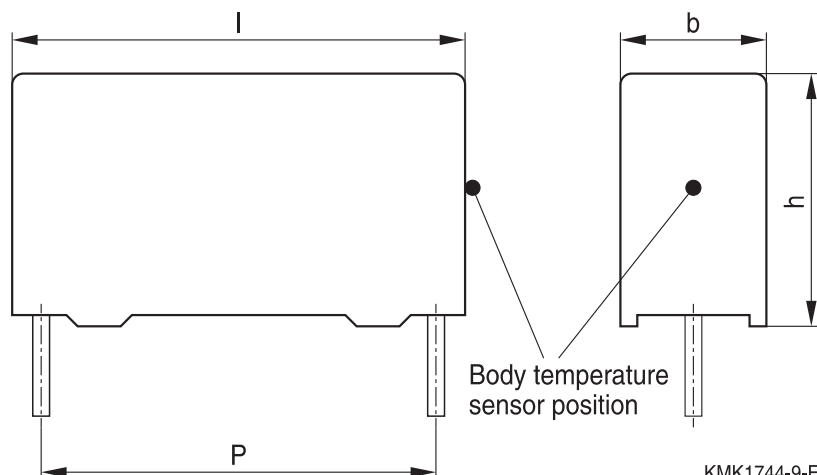

KMK1744-9-E

B32686S

Snubber

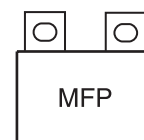

Body temperature should follow the description below:

- MKP capacitor
 - During pre-heating: $T_p \leq 110 \text{ }^\circ\text{C}$
 - During soldering: $T_s \leq 120 \text{ }^\circ\text{C}$, $t_s \leq 45 \text{ s}$
- MKT capacitor
 - During pre-heating: $T_p \leq 125 \text{ }^\circ\text{C}$
 - During soldering: $T_s \leq 160 \text{ }^\circ\text{C}$, $t_s \leq 45 \text{ s}$

When SMD components are used together with leaded ones, the film capacitors should not pass into the SMD adhesive curing oven. The leaded components should be assembled after the SMD curing step.

Leaded film capacitors are not suitable for reflow soldering.

In order to ensure proper conditions for manual or selective soldering, the body temperature of the capacitor (T_s) must be $\leq 120 \text{ }^\circ\text{C}$.

One recommended condition for manual soldering is that the tip of the soldering iron should be $< 360 \text{ }^\circ\text{C}$ and the soldering contact time should be no longer than 3 seconds.

For uncoated MKT capacitors with lead spacings $\leq 10 \text{ mm}$ (B32560/B32561) the following measures are recommended:

- pre-heating to not more than $110 \text{ }^\circ\text{C}$ in the preheater phase
- rapid cooling after soldering

Please refer to EPCOS Film Capacitor Data Book in case more details are needed.

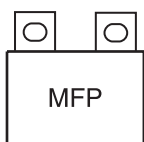

B32686S

Snubber

Cautions and warnings

- Do not exceed the upper category temperature (UCT).
- Do not apply any mechanical stress to the capacitor terminals.
- Avoid any compressive, tensile or flexural stress.
- Do not move the capacitor after it has been soldered to the PC board.
- Do not pick up the PC board by the soldered capacitor.
- Do not place the capacitor on a PC board whose PTH hole spacing differs from the specified lead spacing.
- Do not exceed the specified time or temperature limits during soldering.
- Avoid external energy inputs, such as fire or electricity.
- Avoid overload of the capacitors.
- Consult us if application is with severe temperature and humidity condition.
- There are no serviceable or repairable parts inside the capacitor. Opening the capacitor or any attempts to open or repair the capacitor will void the warranty and liability of EPCOS.
- Please note that the standards referred to in this publication may have been revised in the meantime.

The table below summarizes the safety instructions that must always be observed. A detailed description can be found in the relevant sections of the chapters "General technical information" and "Mounting guidelines".

Topic	Safety information	Reference chapter "General technical information"
Storage conditions	Make sure that capacitors are stored within the specified range of time, temperature and humidity conditions.	4.5 "Storage conditions"
Flammability	Avoid external energy, such as fire or electricity (passive flammability), avoid overload of the capacitors (active flammability) and consider the flammability of materials.	5.3 "Flammability"
Resistance to vibration	Do not exceed the tested ability to withstand vibration. The capacitors are tested to IEC 60068-2-6:2007. EPCOS offers film capacitors specially designed for operation under more severe vibration regimes such as those found in automotive applications. Consult our catalog "Film Capacitors for Automotive Electronics".	5.2 "Resistance to vibration"

Topic	Safety information	Reference chapter "Mounting guidelines"
Soldering	Do not exceed the specified time or temperature limits during soldering.	1 "Soldering"
Cleaning	Use only suitable solvents for cleaning capacitors.	2 "Cleaning"

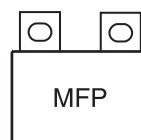

B32686S
Snubber

Topic	Safety information	Reference chapter "Mounting guidelines"
Embedding of capacitors in finished assemblies	<p>When embedding finished circuit assemblies in plastic resins, chemical and thermal influences must be taken into account.</p> <p>Caution: Consult us first, if you also wish to embed other uncoated component types!</p>	3 "Embedding of capacitors in finished assemblies"

Display of ordering codes for EPCOS products

The ordering code for one and the same product can be represented differently in data sheets, data books, other publications and the website of EPCOS, or in order-related documents such as shipping notes, order confirmations and product labels. **The varying representations of the ordering codes are due to different processes employed and do not affect the specifications of the respective products.** Detailed information can be found on the Internet under www.epcos.com/orderingcodes.

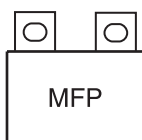

B32686S

Snubber

Symbols and terms

Symbol	English	German
α	Heat transfer coefficient	Wärmeübergangszahl
α_C	Temperature coefficient of capacitance	Temperaturkoeffizient der Kapazität
A	Capacitor surface area	Kondensatoroberfläche
β_C	Humidity coefficient of capacitance	Feuchtekoeffizient der Kapazität
C	Capacitance	Kapazität
C_R	Rated capacitance	Nennkapazität
ΔC	Absolute capacitance change	Absolute Kapazitätsänderung
$\Delta C/C$	Relative capacitance change (relative deviation of actual value)	Relative Kapazitätsänderung (relative Abweichung vom Ist-Wert)
$\Delta C/C_R$	Capacitance tolerance (relative deviation from rated capacitance)	Kapazitätstoleranz (relative Abweichung vom Nennwert)
dt	Time differential	Differentielle Zeit
Δt	Time interval	Zeitintervall
ΔT	Absolute temperature change (self-heating)	Absolute Temperaturänderung (Selbsterwärmung)
$\Delta \tan \delta$	Absolute change of dissipation factor	Absolute Änderung des Verlustfaktors
ΔV	Absolute voltage change	Absolute Spannungsänderung
dV/dt	Time differential of voltage function (rate of voltage rise)	Differentielle Spannungsänderung (Spannungsflankensteilheit)
$\Delta V/\Delta t$	Voltage change per time interval	Spannungsänderung pro Zeitintervall
E	Activation energy for diffusion	Aktivierungsenergie zur Diffusion
ESL	Self-inductance	Eigeninduktivität
ESR	Equivalent series resistance	Ersatz-Serienwiderstand
f	Frequency	Frequenz
f_1	Frequency limit for reducing permissible AC voltage due to thermal limits	Grenzfrequenz für thermisch bedingte Reduzierung der zulässigen Wechselspannung
f_2	Frequency limit for reducing permissible AC voltage due to current limit	Grenzfrequenz für strombedingte Reduzierung der zulässigen Wechselspannung
f_r	Resonant frequency	Resonanzfrequenz
F_D	Thermal acceleration factor for diffusion	Therm. Beschleunigungsfaktor zur Diffusion
F_T	Derating factor	Deratingfaktor
i	Current (peak)	Stromspitze
I_C	Category current (max. continuous current)	Kategoriestrom (max. Dauerstrom)

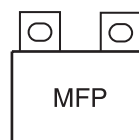

Symbol	English	German
I_{RMS}	(Sinusoidal) alternating current, root-mean-square value	(Sinusförmiger) Wechselstrom
i_z	Capacitance drift	Inkonstanz der Kapazität
k_0	Pulse characteristic	Impuls Kennwert
L_S	Series inductance	Serieninduktivität
λ	Failure rate	Ausfallrate
λ_0	Constant failure rate during useful service life	Konstante Ausfallrate in der Nutzungsphase
λ_{test}	Failure rate, determined by tests	Experimentell ermittelte Ausfallrate
P_{diss}	Dissipated power	Abgegebene Verlustleistung
P_{gen}	Generated power	Erzeugte Verlustleistung
Q	Heat energy	Wärmeenergie
ρ	Density of water vapor in air	Dichte von Wasserdampf in Luft
R	Universal molar constant for gases	Allg. Molarkonstante für Gas
R	Ohmic resistance of discharge circuit	Ohmscher Widerstand des Entladekreises
R_i	Internal resistance	Innenwiderstand
R_{ins}	Insulation resistance	Isolationswiderstand
R_P	Parallel resistance	Parallelwiderstand
R_S	Series resistance	Serienwiderstand
S	severity (humidity test)	Schärfegrad (Feuchtetest)
t	Time	Zeit
T	Temperature	Temperatur
τ	Time constant	Zeitkonstante
$\tan \delta$	Dissipation factor	Verlustfaktor
$\tan \delta_D$	Dielectric component of dissipation factor	Dielektrischer Anteil des Verlustfaktors
$\tan \delta_P$	Parallel component of dissipation factor	Parallelanteil des Verlustfaktors
$\tan \delta_S$	Series component of dissipation factor	Serienanteil des Verlustfaktors
T_A	Temperature of the air surrounding the component	Temperatur der Luft, die das Bauteil umgibt
T_{max}	Upper category temperature	Obere Kategorietemperatur
T_{min}	Lower category temperature	Untere Kategorietemperatur
t_{OL}	Operating life at operating temperature and voltage	Betriebszeit bei Betriebstemperatur und -spannung
T_{op}	Operating temperature, $T_A + \Delta T$	Betriebstemperatur, $T_A + \Delta T$
T_R	Rated temperature	Nenntemperatur
T_{ref}	Reference temperature	Referenztemperatur
t_{SL}	Reference service life	Referenz-Lebensdauer

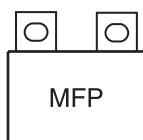

B32686S

Snubber

Symbol	English	German
V_{AC}	AC voltage	Wechselspannung
V_C	Category voltage	Kategorie spannung
$V_{C,RMS}$	Category AC voltage	(Sinusförmige) Kategorie-Wechselspannung
V_{CD}	Corona-discharge onset voltage	Teilentlade-Einsatzspannung
V_{ch}	Charging voltage	Ladespannung
V_{DC}	DC voltage	Gleichspannung
V_{FB}	Fly-back capacitor voltage	Spannung (Flyback)
V_i	Input voltage	Eingangsspannung
V_o	Output voltage	Ausgangsspannung
V_{op}	Operating voltage	Betriebsspannung
V_p	Peak pulse voltage	Impuls-Spitzen spannung
V_{pp}	Peak-to-peak voltage Impedance	Spannungshub
V_R	Rated voltage	Nennspannung
\hat{V}_R	Amplitude of rated AC voltage	Amplitude der Nenn-Wechselspannung
V_{RMS}	(Sinusoidal) alternating voltage, root-mean-square value	(Sinusförmige) Wechselspannung
V_{SC}	S-correction voltage	Spannung bei Anwendung "S-correction"
V_{sn}	Snubber capacitor voltage	Spannung bei Anwendung "Beschaltung"
Z	Impedance	Scheinwiderstand
e	Lead spacing	Rastermaß

Important notes

The following applies to all products named in this publication:

1. Some parts of this publication contain **statements about the suitability of our products for certain areas of application**. These statements are based on our knowledge of typical requirements that are often placed on our products in the areas of application concerned. We nevertheless expressly point out **that such statements cannot be regarded as binding statements about the suitability of our products for a particular customer application**. As a rule, EPCOS is either unfamiliar with individual customer applications or less familiar with them than the customers themselves. For these reasons, it is always ultimately incumbent on the customer to check and decide whether an EPCOS product with the properties described in the product specification is suitable for use in a particular customer application.
2. We also point out that **in individual cases, a malfunction of electronic components or failure before the end of their usual service life cannot be completely ruled out in the current state of the art, even if they are operated as specified**. In customer applications requiring a very high level of operational safety and especially in customer applications in which the malfunction or failure of an electronic component could endanger human life or health (e.g. in accident prevention or lifesaving systems), it must therefore be ensured by means of suitable design of the customer application or other action taken by the customer (e.g. installation of protective circuitry or redundancy) that no injury or damage is sustained by third parties in the event of malfunction or failure of an electronic component.
3. **The warnings, cautions and product-specific notes must be observed.**
4. In order to satisfy certain technical requirements, **some of the products described in this publication may contain substances subject to restrictions in certain jurisdictions (e.g. because they are classed as hazardous)**. Useful information on this will be found in our Material Data Sheets on the Internet (www.epcos.com/material). Should you have any more detailed questions, please contact our sales offices.
5. We constantly strive to improve our products. Consequently, **the products described in this publication may change from time to time**. The same is true of the corresponding product specifications. Please check therefore to what extent product descriptions and specifications contained in this publication are still applicable before or when you place an order. We also **reserve the right to discontinue production and delivery of products**. Consequently, we cannot guarantee that all products named in this publication will always be available. The aforementioned does not apply in the case of individual agreements deviating from the foregoing for customer-specific products.
6. Unless otherwise agreed in individual contracts, **all orders are subject to the current version of the "General Terms of Delivery for Products and Services in the Electrical Industry" published by the German Electrical and Electronics Industry Association (ZVEI)**.

Important notes

7. **Our manufacturing sites serving the automotive business apply the IATF 16949 standard.** The IATF certifications confirm our compliance with requirements regarding the quality management system in the automotive industry. Referring to customer requirements and customer specific requirements (“CSR”) TDK always has and will continue to have the policy of respecting individual agreements. Even if IATF 16949 may appear to support the acceptance of unilateral requirements, we hereby like to emphasize that **only requirements mutually agreed upon can and will be implemented in our Quality Management System.** For clarification purposes we like to point out that obligations from IATF 16949 shall only become legally binding if individually agreed upon.
8. The trade names EPCOS, CeraCharge, CeraDiode, CeraLink, CeraPad, CeraPlas, CSMP, CTVS, DeltaCap, DigiSiMic, ExoCore, FilterCap, FormFit, LeaXield, MiniBlue, MiniCell, MKD, MKK, MotorCap, PCC, PhaseCap, PhaseCube, PhaseMod, PhiCap, PowerHap, PQSine, PQvar, SIFERRIT, SIFI, SIKOREL, SilverCap, SIMDAD, SiMic, SIMID, SineFormer, SIOV, ThermoFuse, WindCap are **trademarks registered or pending** in Europe and in other countries. Further information will be found on the Internet at www.epcos.com/trademarks.

Release 2018-06

Mouser Electronics

Authorized Distributor

Click to View Pricing, Inventory, Delivery & Lifecycle Information:

EPCOS / TDK:

[B32686S474J561](#) [B32686S474J562](#) [B32686S474J563](#) [B32686S0474J561](#) [B32686S0474J562](#) [B32686S0474J563](#)
[B32686S7224J563](#) [B32686S7224J564](#) [B32686S7224J565](#) [B32686S7474K561](#) [B32686S1274K562](#)
[B32686S2223K563](#) [B32686S2223K564](#) [B32686S2473K563](#) [B32686S2473K564](#) [B32686S1104K564](#)
[B32686S0684K563](#)