

LP295x-N Series of Adjustable Micropower Voltage Regulators

1 Features

- Input Voltage Range: 2.3 V to 30 V
- 5-V, 3-V, and 3.3-V Output Voltage Versions Available
- High Accuracy Output Voltage
- Ensured 100-mA Output Current
- Extremely Low Quiescent Current
- Low Dropout Voltage
- Extremely Tight Load and Line Regulation
- Very Low Temperature Coefficient
- Use as Regulator or Reference
- Needs Minimum Capacitance for Stability
- Current and Thermal Limiting
- Stable With Low-ESR Output Capacitors (10 m Ω to 6 Ω)
- LP2951-N Versions Only:
 - Error Flag Warns of Output Dropout
 - Logic-Controlled Electronic Shutdown
 - Output Programmable From 1.24 V to 29 V

2 Applications

- High-Efficiency Linear Regulator
- Regulator with Undervoltage Shutdown
- Low Dropout Battery-powered Regulator
- Snap-ON/Snap-OFF Regulator

3 Description

The LP2950-N and LP2951-N are micropower voltage regulators with very low quiescent current (75 μ A typical) and very low dropout voltage (typical 40 mV at light loads and 380 mV at 100 mA). They are ideally suited for use in battery-powered systems. Furthermore, the quiescent current of the device increases only slightly in dropout, prolonging battery life.

Careful design of the LP2950-N/LP2951-N has minimized all contributions to the error budget. This includes a tight initial tolerance (0.5% typical), extremely good load and line regulation (0.05% typical) and a very low output voltage temperature coefficient, making the part useful as a low-power voltage reference.

One such feature is an error flag output which warns of a low output voltage, often due to falling batteries on the input. It may be used for a power-on reset. A second feature is the logic-compatible shutdown input which enables the regulator to be switched on and off. Also, the part may be pin-strapped for a 5-V, 3-V, or 3.3-V output (depending on the version), or programmed from 1.24 V to 29 V with an external pair of resistors.

The LP2950-N is available in the surface-mount TO-252 package and in the popular 3-pin TO-92 package for pin-compatibility with older 5-V regulators. The 8-pin LP2951-N is available in plastic, ceramic dual-in-line, WSON, or metal can packages and offers additional system functions.

Device Information⁽¹⁾

PART NUMBER	PACKAGE	BODY SIZE (NOM)
LP2950-N	TO-92 (3)	4.30 mm x 4.30 mm
	TO-252 (3)	9.91 mm x 6.58 mm
LP2951-N	SOIC (8)	4.90 mm x 3.91 mm
	VSSOP (8)	3.00 mm x 3.00 mm
	WSON (8)	4.00 mm x 4.00 mm
	PDIP (8)	9.81 mm x 6.35 mm

(1) For all available packages, see the orderable addendum at the end of the data sheet.

LP2951 Simplified Schematic



LP2950-N Simplified Schematic

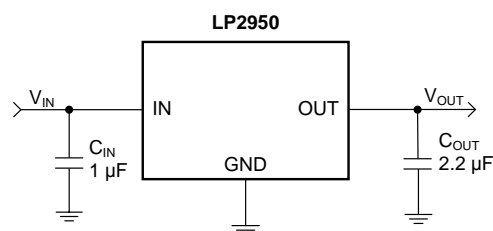

Table of Contents

1 Features	1	8.4 Device Functional Modes.....	18
2 Applications	1	9 Application and Implementation	19
3 Description	1	9.1 Application Information.....	19
4 Revision History	2	9.2 Typical Applications	20
5 Voltage Options	3	10 Power Supply Recommendations	32
6 Pin Configuration and Functions	4	11 Layout	32
7 Specifications	5	11.1 Layout Guidelines	32
7.1 Absolute Maximum Ratings	5	11.2 Layout Example	32
7.2 ESD Ratings.....	5	11.3 WSON Mounting	33
7.3 Recommended Operating Conditions.....	5	12 Device and Documentation Support	34
7.4 Thermal Information: LP2950-N.....	6	12.1 Documentation Support	34
7.5 Thermal Information: LP2951-N.....	6	12.2 Related Links	34
7.6 Electrical Characteristics.....	7	12.3 Community Resources.....	34
7.7 Typical Characteristics	10	12.4 Trademarks	34
8 Detailed Description	16	12.5 Electrostatic Discharge Caution.....	34
8.1 Overview	16	12.6 Glossary	34
8.2 Functional Block Diagrams	16	13 Mechanical, Packaging, and Orderable	34
8.3 Feature Description.....	17	Information	34

4 Revision History

NOTE: Page numbers for previous revisions may differ from page numbers in the current version.

Changes from Revision P (May 2016) to Revision Q	Page
<ul style="list-style-type: none"> Changed LP2951-N ESD parameter pin references and added SENSE pin row to LP2951-N ESD parameter in <i>ESD Ratings</i> table..... 	5
<hr/>	
Changes from Revision O (December 2014) to Revision P	Page
<ul style="list-style-type: none"> Added rows to <i>ESD Ratings</i> table to differentiate values for pins 3 and 7 of the LP2951-N device..... Added footnotes 2 and 3 to both <i>Thermal Information</i> tables 	5 6
<hr/>	
Changes from Revision N (May 2013) to Revision O	Page
<ul style="list-style-type: none"> Added <i>Device Information</i> and <i>ESD Rating</i> tables, <i>Feature Description</i>, <i>Device Functional Modes</i>, <i>Application and Implementation</i>, <i>Power Supply Recommendations</i>, <i>Layout</i>, <i>Device and Documentation Support</i>, and <i>Mechanical, Packaging, and Orderable Information</i> sections; moved some curves to <i>Application Curves</i> section; update pin names; change package nomenclature from National to TI 	1
<hr/>	
Changes from Revision M (April 2013) to Revision N	Page
<ul style="list-style-type: none"> Changed layout of National Data Sheet to TI format 	1

5 Voltage Options

DEVICE NUMBER	PACKAGE	VOLTAGE OPTION (V)
LP2950-N	TO-92 (LP)	3 ($\pm 0.5\%$, $\pm 1\%$)
		3.3 ($\pm 0.5\%$, $\pm 1\%$)
		5 ($\pm 0.5\%$, $\pm 1\%$)
	TO-252 (NDP)	3 ($\pm 1\%$)
		3.3 ($\pm 1\%$)
		5 ($\pm 1\%$)
LP2951-N	SOIC (D)	3 ($\pm 0.5\%$, $\pm 1\%$)
		3.3 ($\pm 0.5\%$, $\pm 1\%$)
		5 ($\pm 0.5\%$, $\pm 1\%$)
	VSSOP (DGK)	3 ($\pm 0.5\%$, $\pm 1\%$)
		3.3 ($\pm 0.5\%$, $\pm 1\%$)
		5 ($\pm 0.5\%$, $\pm 1\%$)
	WSON (NGT)	3 ($\pm 0.5\%$, $\pm 1\%$)
		3.3 ($\pm 0.5\%$, $\pm 1\%$)
		5 ($\pm 0.5\%$, $\pm 1\%$)
	PDIP (P)	5 ($\pm 0.5\%$, $\pm 1\%$)

6 Pin Configuration and Functions



Pin Functions: LP2950-N

NAME	PIN		I/O	DESCRIPTION
	LP2950			
	LP	NDP		
GND	2	2	—	Ground
IN	3	1	I	Input supply voltage
OUT	1	3	O	Regulated output voltage

Pin Functions: LP2951-N

NAME	PIN		I/O	DESCRIPTION
	LP2951			
	D, DGK, P	NGT		
ERROR	5	5	O	Error output
FEEDBACK	7	7	I	Voltage feedback input
GROUND	4	4	—	Ground
IN	8	8	I	Input supply voltage
OUT	1	1	O	Regulated output voltage
SENSE	2	2	I	Output voltage sense
SHUTDOWN	3	3	I	Disable device
VTAP	6	6	O	Internal resistor divider

7 Specifications

7.1 Absolute Maximum Ratings

over operating free-air temperature range (unless otherwise noted)⁽¹⁾⁽²⁾

		MIN	MAX	UNIT
Input supply voltage - SHUTDOWN input voltage error comparator output voltage ⁽³⁾		-0.3	30	V
FEEDBACK input voltage ⁽³⁾⁽⁴⁾		-1.5	30	V
Power dissipation		Internally Limited		
Junction temperature, T _J		150		°C
Soldering dwell time, temperature	Wave	4 seconds, 260		
	Infrared	10 seconds, 240		
	Vapor phase	75 seconds, 219		
Storage temperature, T _{stg}		-65	150	°C

- (1) Stresses beyond those listed under *Absolute Maximum Ratings* may cause permanent damage to the device. These are stress ratings only, which do not imply functional operation of the device at these or any other conditions beyond those indicated under *Recommended Operating Conditions*. Exposure to absolute-maximum-rated conditions for extended periods may affect device reliability.
- (2) If Military/Aerospace specified devices are required, contact the Texas Instruments Sales Office/Distributors for availability and specifications.
- (3) May exceed input supply voltage.
- (4) When used in dual-supply systems where the output terminal sees loads returned to a negative supply, the output voltage should be diode-clamped to ground.

7.2 ESD Ratings

			VALUE	UNIT
LP2950-N				
V _(ESD)	Electrostatic discharge	Human-body model (HBM), per ANSI/ESDA/JEDEC JS-001 ⁽¹⁾	±2500	V
LP2951-N				
V _(ESD)	Electrostatic discharge	Human-body model (HBM), per ANSI/ESDA/JEDEC JS-001 ⁽¹⁾	IN, OUT, GND, ERROR	±2500
			SHUTDOWN	±2000
			SENSE	±1500
			VTAP, FEEDBACK	±1000

- (1) JEDEC document JEP155 states that 500-V HBM allows safe manufacturing with a standard ESD control process.

7.3 Recommended Operating Conditions

over operating free-air temperature range (unless otherwise noted)⁽¹⁾

		MIN	MAX	UNIT
Maximum input supply voltage			30	V
Junction temperature, T _J ⁽²⁾	LP2950AC-XX, LP2950C-XX	-40	125	°C
	LP2951	-55	150	°C
	LP2951AC-XX, LP2951C-XX	-40	125	°C

- (1) Stresses beyond those listed under *Absolute Maximum Ratings* may cause permanent damage to the device. These are stress ratings only, which do not imply functional operation of the device at these or any other conditions beyond those indicated under *Recommended Operating Conditions*. Exposure to absolute-maximum-rated conditions for extended periods may affect device reliability.
- (2) The junction-to-ambient thermal resistances are as follows: 157.4°C/W for the TO-92 (LP) package, 51.3°C/W for the TO-252 (NDP) package, 56.3°C/W for the molded PDIP (P), 117.7°C/W for the molded plastic SOIC (D), 171°C/W for the molded plastic VSSOP (DGK). The above thermal resistances for the P, D, and DGK packages apply when the package is soldered directly to the PCB. The value of R_{θJA} for the WSON (NGT) package is typically 43.3°C/W but is dependent on the PCB trace area, trace material, and the number of layers and thermal vias. For details of thermal resistance and power dissipation for the WSON package, see [AN-1187 Leadless Leadframe Package \(LLP\)](#).

7.4 Thermal Information: LP2950-N

THERMAL METRIC ⁽¹⁾		LP2950-N		UNIT
		LP (TO-92)	NDP (TO-252)	
		3 PINS	3 PINS	
$R_{\theta JA}^{(2)}$	Junction-to-ambient thermal resistance, High-K	157.4	51.3 ⁽³⁾	°C/W
$R_{\theta JC(top)}$	Junction-to-case (top) thermal resistance	81.2	53.5	°C/W
$R_{\theta JB}$	Junction-to-board thermal resistance	153.6	30.4	°C/W
Ψ_{JT}	Junction-to-top characterization parameter	25.2	5.5	°C/W
Ψ_{JB}	Junction-to-board characterization parameter	n/a	30	°C/W
$R_{\theta JC(bot)}$	Junction-to-case (bottom) thermal resistance	n/a	2.2	°C/W

- (1) For more information about traditional and new thermal metrics, see the [Semiconductor and IC Package Thermal Metrics](#) application report.
- (2) Thermal resistance value $R_{\theta JA}$ is based on the EIA/JEDEC High-K printed circuit board defined by *JESD51-7 - High Effective Thermal Conductivity Test Board for Leaded Surface Mount Packages*.
- (3) The PCB for the TO-252 (NDP) package $R_{\theta JA}$ includes twelve (12) thermal vias under the tab per EIA/JEDEC JESD51-5.

7.5 Thermal Information: LP2951-N

THERMAL METRIC ⁽¹⁾		LP2951-N				UNIT
		P (PDIP)	D (SOIC)	DGK (VSSOP)	NGT (WSON)	
		8 PINS	8 PINS	8 PINS	8 PINS	
$R_{\theta JA}^{(2)}$	Junction-to-ambient thermal resistance, High K	56.3	117.7	171.0	43.3 ⁽³⁾	°C/W
$R_{\theta JC(top)}$	Junction-to-case (top) thermal resistance	45.7	63.7	62.3	35.0	°C/W
$R_{\theta JB}$	Junction-to-board thermal resistance	33.5	57.9	91.4	23.3	°C/W
Ψ_{JT}	Junction-to-top characterization parameter	22.9	15.9	8.9	0.5	°C/W
Ψ_{JB}	Junction-to-board characterization parameter	33.3	57.5	90.1	20.5	°C/W
$R_{\theta JC(bot)}$	Junction-to-case (bottom) thermal resistance	n/a	n/a	n/a	9.1	°C/W

- (1) For more information about traditional and new thermal metrics, see the [Semiconductor and IC Package Thermal Metrics](#) application report.
- (2) Thermal resistance value $R_{\theta JA}$ is based on the EIA/JEDEC High-K printed circuit board defined by *JESD51-7 - High Effective Thermal Conductivity Test Board for Leaded Surface Mount Packages*.
- (3) The PCB for the WSON (NGT) package $R_{\theta JA}$ includes six (6) thermal vias under the exposed thermal pad per EIA/JEDEC JESD51-5.

7.6 Electrical Characteristics

over operating free-air temperature range (unless otherwise noted)⁽¹⁾

PARAMETER	TEST CONDITIONS ⁽¹⁾	LP2951 ⁽²⁾			LP2950AC-XX LP2951AC-XX			LP2950C-XX LP2951C-XX			UNIT
		MIN	TYP	MAX	MIN	TYP	MAX	MIN	TYP	MAX	
3-V VERSIONS⁽³⁾											
Output voltage	T _J = 25°C	2.985	3	3.015	2.985	3	3.015	2.970	3	3.030	V ⁽⁴⁾
	-25°C ≤ T _J ≤ 85°C				2.970	3	3.030	2.955	3	3.045	V ⁽⁵⁾
	Full operating temperature range	2.964	3	3.036							V ⁽⁴⁾
Output voltage	100 μA ≤ I _L ≤ 100 mA, 100 μA ≤ I _L ≤ 100 mA, T _J ≤ T _{JMAX}	2.955	3	3.045							V ⁽⁴⁾
					2.958	3	3.042	2.928	3	3.072	V ⁽⁵⁾
3.3-V VERSIONS⁽³⁾											
Output voltage	T _J = 25°C	3.284	3.3	3.317	3.284	3.3	3.317	3.267	3.3	3.333	V ⁽⁴⁾
	-25°C ≤ T _J ≤ 85°C		3.3		3.267	3.3	3.333	3.251	3.3	3.350	V ⁽⁵⁾
	Full operating temperature range	3.260	3.3	3.340							V ⁽⁴⁾
Output voltage	100 μA ≤ I _L ≤ 100 mA, T _J ≤ T _{JMAX}	3.251	3.3	3.350							V ⁽⁴⁾
					3.254	3.3	3.346	3.221	3.3	3.379	V ⁽⁵⁾
5-V VERSIONS⁽³⁾											
Output voltage	T _J = 25°C	4.975	5	5.025	4.975	5	5.025	4.95	5	5.05	V ⁽⁴⁾
	-25°C ≤ T _J ≤ 85°C		5		4.95	5	5.05	4.925	5	5.075	V ⁽⁵⁾
	Full operating temperature range	4.94	5	5.06							V ⁽⁴⁾
Output voltage	100 μA ≤ I _L ≤ 100 mA, T _J ≤ T _{JMAX}	4.925	5	5.075							V ⁽⁴⁾
					4.925	5	5.075	4.88	5	5.12	V ⁽⁵⁾
ALL VOLTAGE OPTIONS											
Output voltage temperature coefficient	See ⁽⁶⁾ , -40°C ≤ T _J ≤ 125°C	20	120								ppm/°C ⁽⁴⁾
					20	100		50	150		ppm/°C ⁽⁵⁾
Line regulation ⁽⁷⁾	(V _O NOM + 1 V) ≤ V _{in} ≤ 30 V ⁽⁸⁾	0.03%	0.1%		0.03%	0.11%		0.04%	0.2%		See ⁽⁴⁾
	(V _O NOM + 1 V) ≤ V _{in} ≤ 30 V ⁽⁸⁾ , -40°C ≤ T _J ≤ 125°C	0.03%	0.5%								See ⁽⁴⁾
Load regulation ⁽⁷⁾	100 μA ≤ I _L ≤ 100 mA	0.04%	0.1%		0.04%	0.1%		0.1%	0.2%		See ⁽⁴⁾
	100 μA ≤ I _L ≤ 100 mA, -40°C ≤ T _J ≤ 125°C	0.04%	0.3%					0.1%	0.3%		See ⁽⁵⁾

- Unless otherwise noted, all limits apply for T_A = T_J = 25°C as well as specified for V_{IN} = (V_ONOM + 1 V), I_L = 100 μA and C_L = 1 μF for 5-V versions and 2.2 μF for 3-V and 3.3-V versions. Additional conditions for the 8-pin versions are FEEDBACK tied to VTAP, OUTPUT tied to SENSE, and V_{SHUTDOWN} ≤ 0.8 V.
- A Military RETS specification is available on request.
- All LP2950 devices have the nominal output voltage coded as the last two digits of the part number. In the LP2951 products, the 3-V and 3.3-V versions are designated by the last two digits, but the 5-V version is denoted with no code at this location of the part number (refer to the *Package Option Addendum* at end of data sheet).
- Ensured and 100% production tested.
- Ensured but not 100% production tested. These limits are not used to calculate outgoing AQL levels.
- Output or reference voltage temperature coefficient is defined as the worst case voltage change divided by the total temperature range.
- Regulation is measured at constant junction temperature, using pulse testing with a low duty cycle. Changes in output voltage due to heating effects are covered under the specification for thermal regulation.
- Line regulation for the LP2951-N is tested at 150°C for I_L = 1 mA. For I_L = 100 μA and T_J = 125°C, line regulation is specified by design to 0.2%. See *Typical Characteristics* for line regulation versus temperature and load current.

Electrical Characteristics (continued)

 over operating free-air temperature range (unless otherwise noted)⁽¹⁾

PARAMETER	TEST CONDITIONS ⁽¹⁾	LP2951 ⁽²⁾			LP2950AC-XX LP2951AC-XX			LP2950C-XX LP2951C-XX			UNIT	
		MIN	TYP	MAX	MIN	TYP	MAX	MIN	TYP	MAX		
Dropout voltage ⁽⁹⁾	$I_L = 100 \mu\text{A}$		50	80		50	80		50	80	mV ⁽⁴⁾	
	$I_L = 100 \mu\text{A}, -40^\circ\text{C} \leq T_J \leq 125^\circ\text{C}$			150							mV ⁽⁴⁾	
							150			150	mV ⁽⁵⁾	
	$I_L = 100 \text{ mA}$		380	450		380	450		380	450	mV ⁽⁴⁾	
$I_L = 100 \text{ mA}, -40^\circ\text{C} \leq T_J \leq 125^\circ\text{C}$				600			600			600	mV ⁽⁴⁾	
						600			600	mV ⁽⁵⁾		
Ground current	$I_L = 100 \mu\text{A}$		75	120		75	120		75	120	μA ⁽⁴⁾	
	$I_L = 100 \mu\text{A}, -40^\circ\text{C} \leq T_J \leq 125^\circ\text{C}$			140						140	μA ⁽⁴⁾	
							140			140	μA ⁽⁵⁾	
	$I_L = 100 \text{ mA}$		8	12		8	12		8	12	mA ⁽⁴⁾	
$I_L = 100 \text{ mA}, -40^\circ\text{C} \leq T_J \leq 125^\circ\text{C}$				14			14			14	mA ⁽⁴⁾	
						14			14	mA ⁽⁵⁾		
Dropout ground current	$V_{IN} = (V_{ONOM} - 0.5)\text{V}, I_L = 100 \mu\text{A}$		110	170		110	170		110	170	μA ⁽⁴⁾	
	$V_{IN} = (V_{ONOM} - 0.5)\text{V}, I_L = 100 \mu\text{A}, -40^\circ\text{C} \leq T_J \leq 125^\circ\text{C}$			200			200			200	μA ⁽⁴⁾	
						200			200	μA ⁽⁵⁾		
Current limit	$V_{OUT} = 0 \text{ V}$		160	200		160	200		160	200	mA ⁽⁴⁾	
	$V_{OUT} = 0 \text{ V}, -40^\circ\text{C} \leq T_J \leq 125^\circ\text{C}$			220						220	mA ⁽⁴⁾	
						220			220	mA ⁽⁵⁾		
Thermal regulation	See ⁽¹⁰⁾		0.05	0.2		0.05	0.2		0.05	0.2	%/W ⁽⁴⁾	
Output noise 10 Hz to 100 kHz	$C_L = 1 \mu\text{F}$ (5 V Only)		430			430			430		μV_{RMS}	
	$C_L = 200 \mu\text{F}$		160			160			160		μV_{RMS}	
	$C_L = 3.3 \mu\text{F}$ (Bypass = 0.01 μF Pins 7 to 1 (LP2951-N))		100			100			100		μV_{RMS}	
8-PIN VERSIONS ONLY		LP2951			LP2951AC-XX			LP2951C-XX				
Reference voltage		1.22	1.235	1.25	1.22	1.235	1.25	1.21	1.235	1.26	V ⁽⁴⁾	
	$-40^\circ\text{C} \leq T_J \leq 125^\circ\text{C}$		1.2	1.26							V ⁽⁴⁾	
Reference voltage					1.2		1.26	1	1.2		1.27	V ⁽⁵⁾
	$\text{See}^{(11)}, -40^\circ\text{C} \leq T_J \leq 125^\circ\text{C}$	1.19		1.27							V ⁽⁴⁾	
Reference voltage					1.19		1.27	1.185		1.285	V ⁽⁵⁾	
			20	40		20	40		20	40	nA ⁽⁴⁾	
Feedback pin bias current				60							nA ⁽⁴⁾	
	$-40^\circ\text{C} \leq T_J \leq 125^\circ\text{C}$						60			60	nA ⁽⁵⁾	
Reference voltage temperature coefficient	See ⁽⁶⁾		20			20			50		ppm/°C	
Feedback pin bias current temperature coefficient			0.1			0.1			0.1		nA/°C	

(9) Dropout voltage is defined as the input to output differential at which the output voltage drops 100 mV below its nominal value measured at 1-V differential. At very low values of programmed output voltage, the minimum input supply voltage of 2 V (2.3 V over temperature) must be taken into account.

(10) Thermal regulation is defined as the change in output voltage at a time T after a change in power dissipation is applied, excluding load or line regulation effects. Specifications are for a 50 mA load pulse at $V_{IN} = 30 \text{ V}$ (1.25-W pulse) for $T = 10 \text{ ms}$.

(11) $V_{REF} \leq V_{OUT} \leq (V_{IN} - 1 \text{ V}), 2.3 \text{ V} \leq V_{IN} \leq 30 \text{ V}, 100 \mu\text{A} \leq I_L \leq 100 \text{ mA}, T_J \leq T_{J\text{MAX}}$.

Electrical Characteristics (continued)

over operating free-air temperature range (unless otherwise noted)⁽¹⁾

PARAMETER	TEST CONDITIONS ⁽¹⁾	LP2951 ⁽²⁾			LP2950AC-XX LP2951AC-XX			LP2950C-XX LP2951C-XX			UNIT
		MIN	TYP	MAX	MIN	TYP	MAX	MIN	TYP	MAX	
ERROR COMPARATOR											
Output leakage current	$V_{OH} = 30\text{ V}$		0.01	1		0.01	1		0.01	1	$\mu\text{A}^{(4)}$
	$V_{OH} = 30\text{ V}, -40^\circ\text{C} \leq T_J \leq 125^\circ\text{C}$			2							$\mu\text{A}^{(4)}$
							2				2
Output low voltage	$V_{IN} = (V_{O(NOM)} - 0.5\text{ V}), I_{OL} = 400\ \mu\text{A}$		150	250		150	250		150	250	$\text{mV}^{(4)}$
	$V_{IN} = (V_{O(NOM)} - 0.5\text{ V}), I_{OL} = 400\ \mu\text{A}, -40^\circ\text{C} \leq T_J \leq 125^\circ\text{C}$			400		400			400		$\text{mV}^{(4)}$
							400			400	$\text{mV}^{(5)}$
Upper threshold voltage	See ⁽¹²⁾		40	60		40	60		40	60	$\text{mV}^{(4)}$
	See ⁽¹²⁾ , $-40^\circ\text{C} \leq T_J \leq 125^\circ\text{C}$		25								$\text{mV}^{(4)}$
						25			25		$\text{mV}^{(5)}$
Lower threshold voltage	See ⁽¹²⁾		75	95		75	95		75	95	$\text{mV}^{(4)}$
	See ⁽¹²⁾ , $-40^\circ\text{C} \leq T_J \leq 125^\circ\text{C}$			140							$\text{mV}^{(4)}$
							140			140	$\text{mV}^{(5)}$
Hysteresis	See ⁽¹²⁾		15			15			15	mV	
SHUTDOWN INPUT											
Input			1.3			1.3			1.3		V
Logic voltage	Low (Regulator ON), $-40^\circ\text{C} \leq T_J \leq 125^\circ\text{C}$			0.6							$\text{V}^{(4)}$
							0.7			0.7	$\text{V}^{(5)}$
Logic voltage	High (Regulator OFF), $-40^\circ\text{C} \leq T_J \leq 125^\circ\text{C}$	2									$\text{V}^{(4)}$
					2			2			$\text{V}^{(5)}$
Shutdown pin input current	$V_{\text{shutdown}} = 2.4\text{ V}$		30	50		30	50		30	50	$\mu\text{A}^{(4)}$
	$V_{\text{shutdown}} = 2.4\text{ V}, -40^\circ\text{C} \leq T_J \leq 125^\circ\text{C}$			100							$\mu\text{A}^{(4)}$
							100			100	$\mu\text{A}^{(5)}$
	$V_{\text{shutdown}} = 30\text{ V}$		450	600		450	600		450	600	$\mu\text{A}^{(4)}$
	$V_{\text{shutdown}} = 30\text{ V}, -40^\circ\text{C} \leq T_J \leq 125^\circ\text{C}$				750						750
						750			750	$\mu\text{A}^{(5)}$	
Regulator output current in shutdown	See ⁽¹³⁾		3	10		3	10		3	10	$\mu\text{A}^{(4)}$
	$-40^\circ\text{C} \leq T_J \leq 125^\circ\text{C}$			20						20	$\mu\text{A}^{(4)}$
						20			20	$\mu\text{A}^{(5)}$	

(12) Comparator thresholds are expressed in terms of a voltage differential at the FEEDBACK pin below the nominal reference voltage measured at $V_{IN} = (V_{O(NOM)} + 1)\text{ V}$. To express these thresholds in terms of output voltage change, multiply by the error amplifier gain = $V_{OUT}/V_{REF} = (R1 + R2) / R2$. For example, at a programmed output voltage of 5 V, the ERROR output is specified to go low when the output drops by $95\text{ mV} \times 5\text{ V} / 1.235\text{ V} = 384\text{ mV}$. Thresholds remain constant as a percent of V_{OUT} as V_{OUT} is varied, with the dropout warning occurring at typically 5% below nominal, 7.5% ensured.

(13) $V_{\text{SHUTDOWN}} \geq 2\text{ V}$, $V_{IN} \leq 30\text{ V}$, $V_{OUT} = 0$, FEEDBACK pin tied to V_{TAP} .

7.7 Typical Characteristics

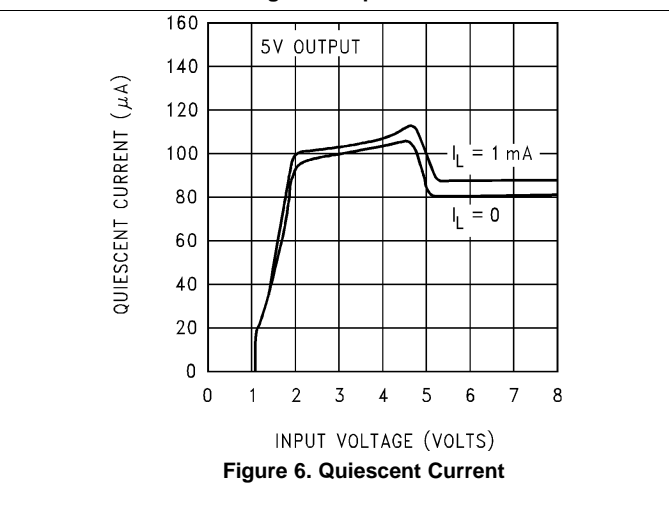
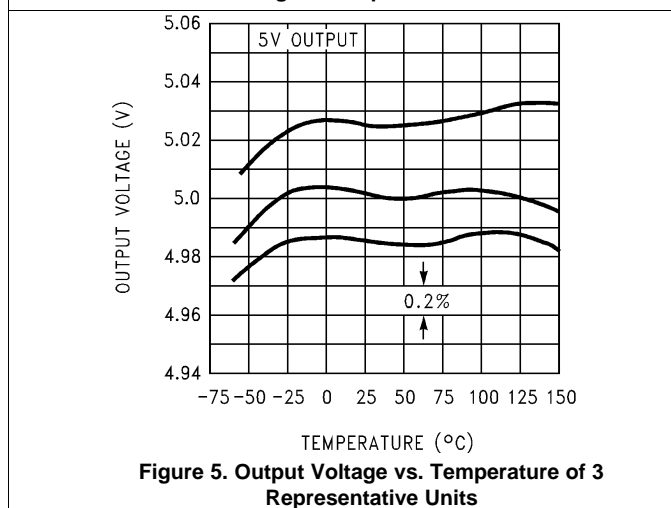
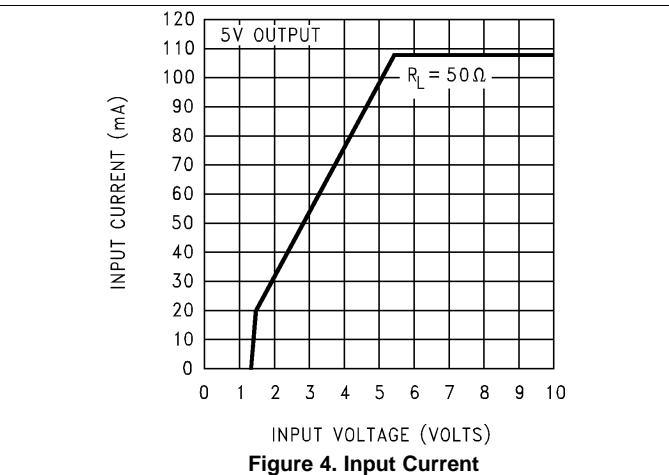
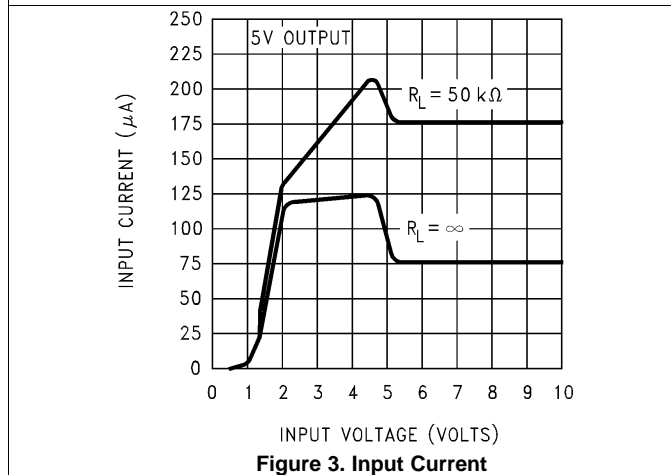
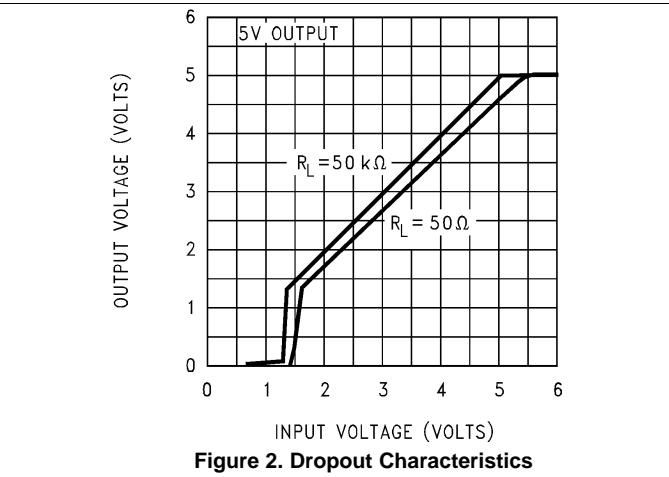
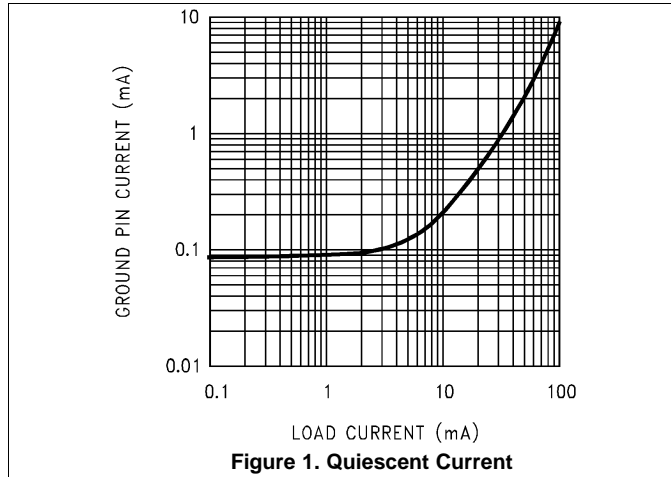

Typical Characteristics (continued)

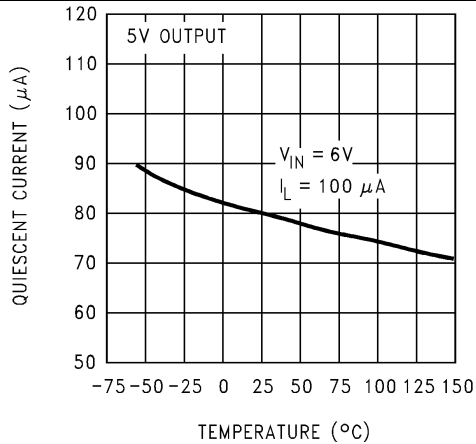

Figure 7. Quiescent Current

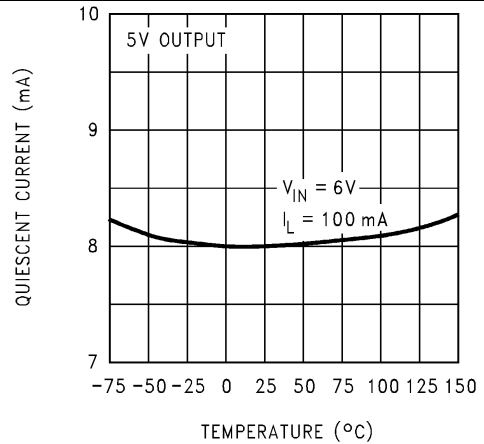

Figure 8. Quiescent Current

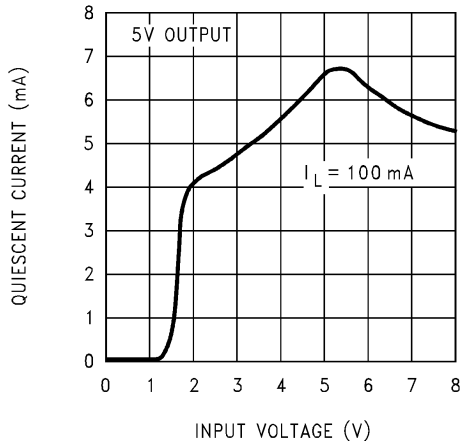

Figure 9. Quiescent Current

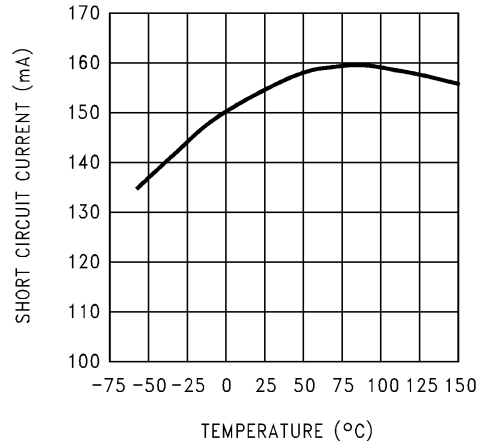

Figure 10. Short Circuit Current



Figure 11. Dropout Voltage

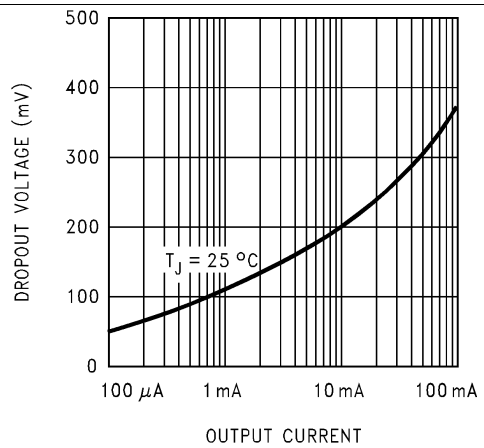
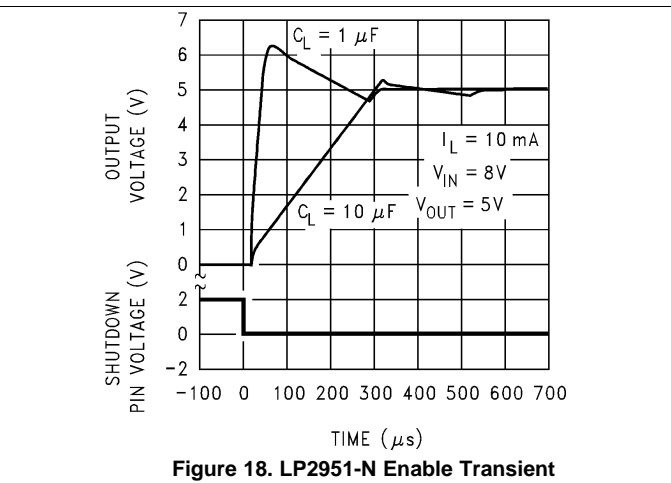
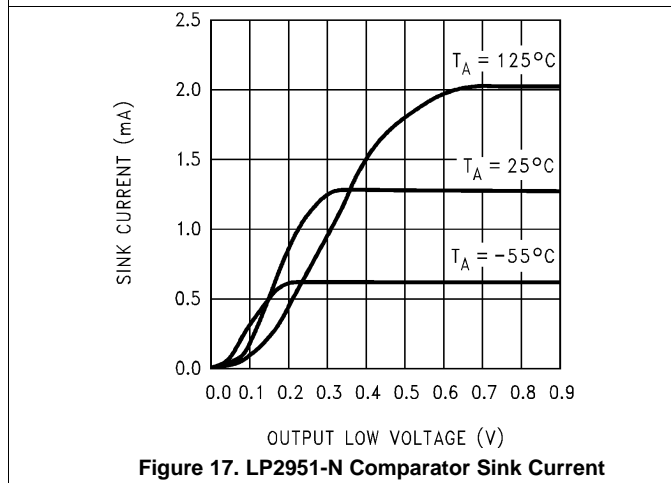
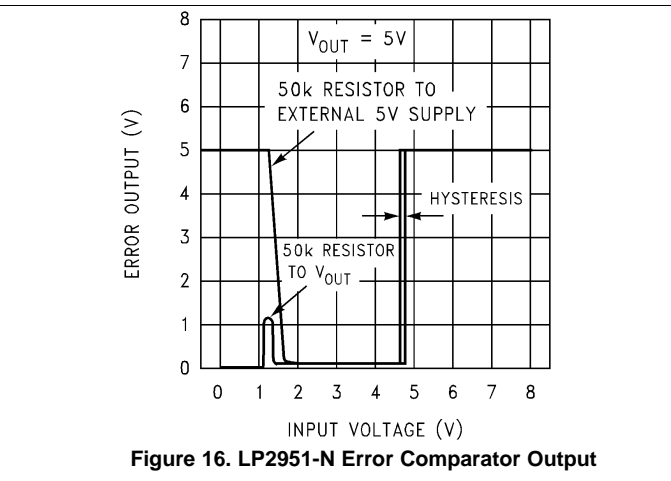
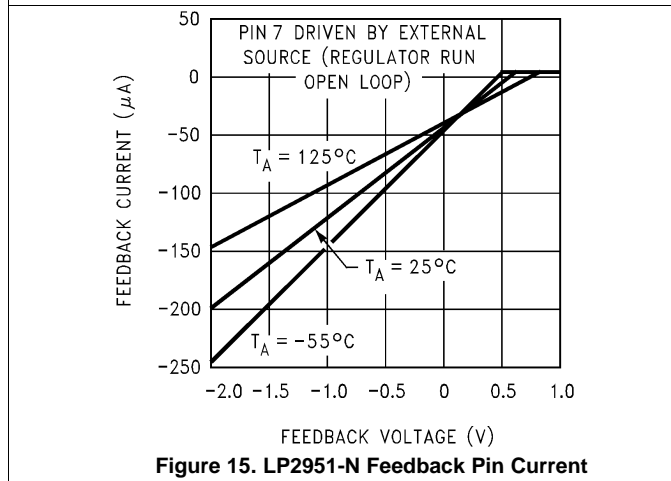
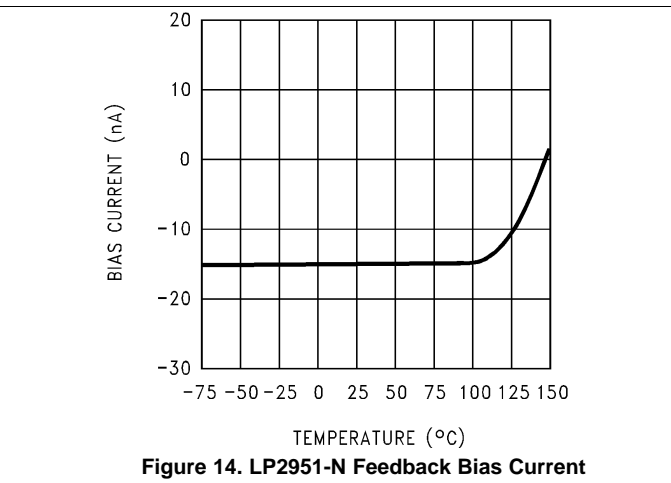
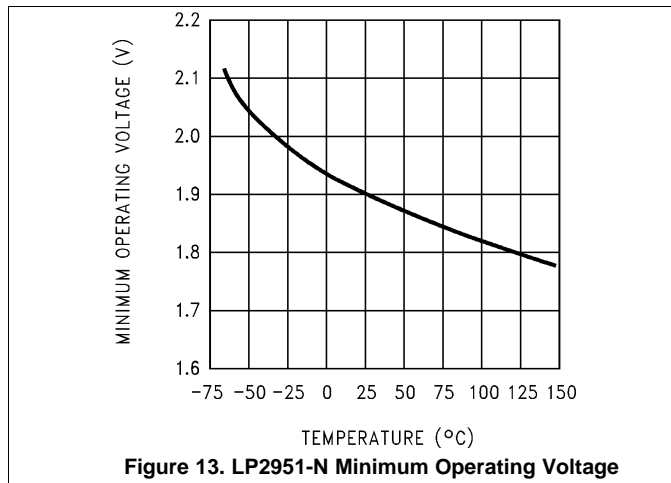
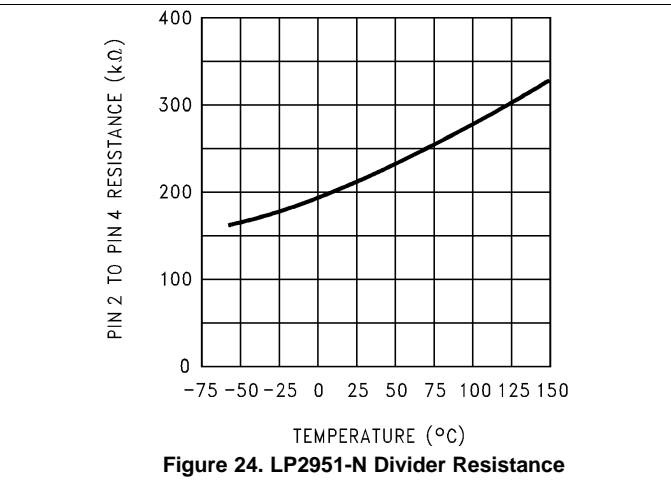
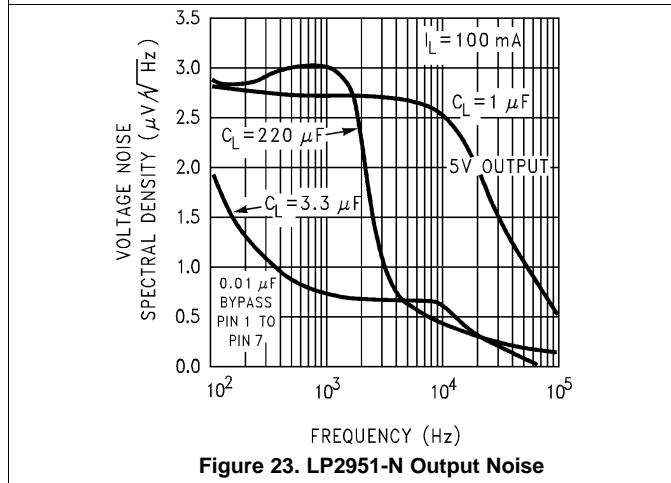
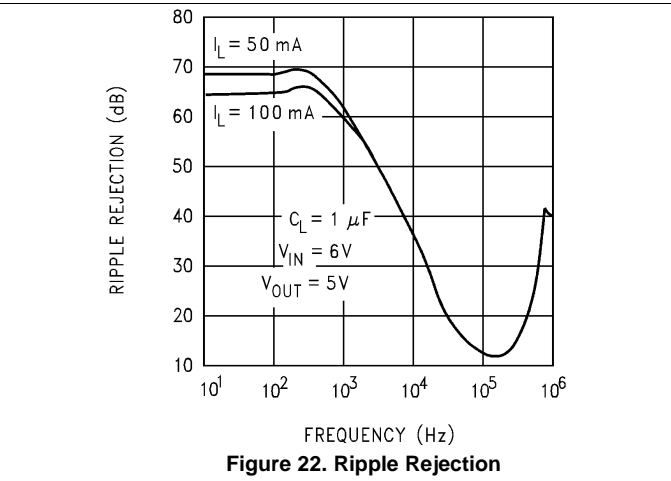
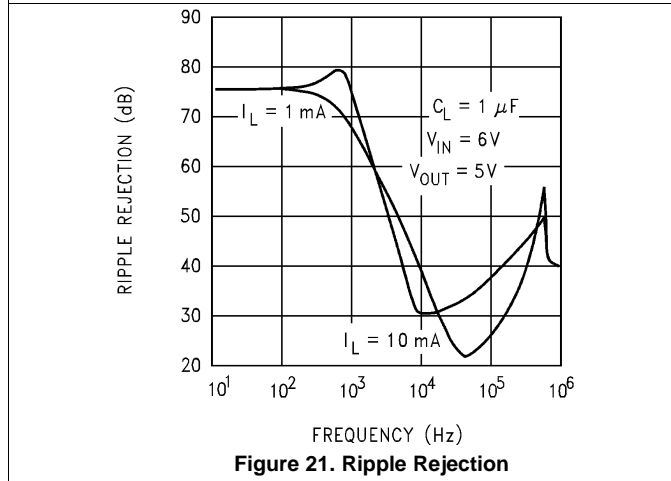
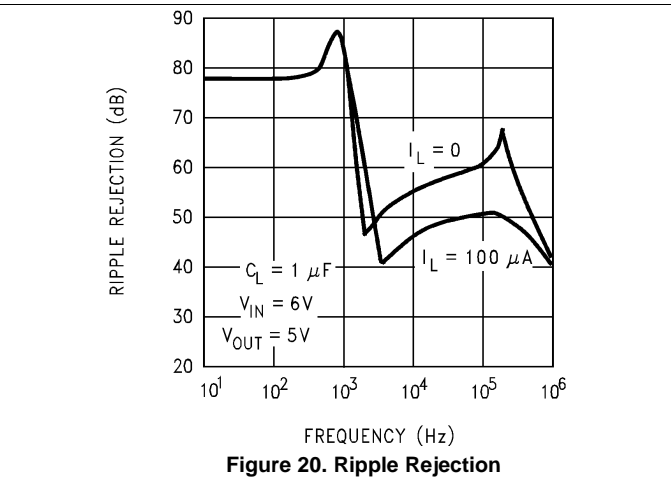
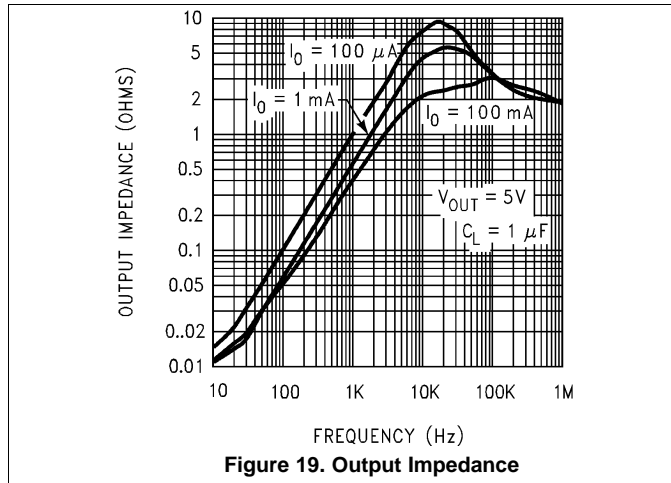

Figure 12. Dropout Voltage

Typical Characteristics (continued)



Typical Characteristics (continued)



Typical Characteristics (continued)



Figure 25. Shutdown Threshold Voltage

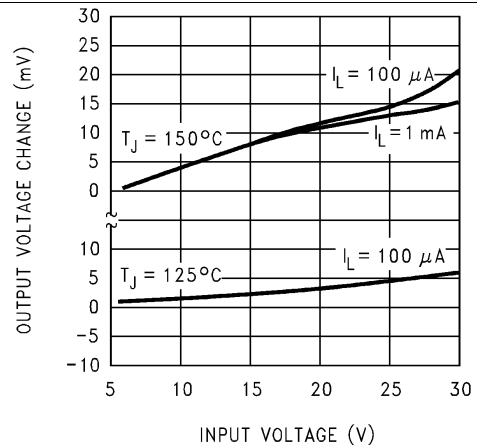

Figure 26. Line Regulation



Figure 27. LP2951-N Maximum Rated Output Current

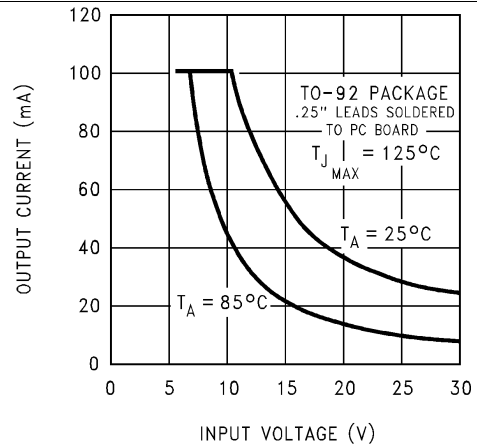

Figure 28. LP2950-N Maximum Rated Output Current



Figure 29. Thermal Response

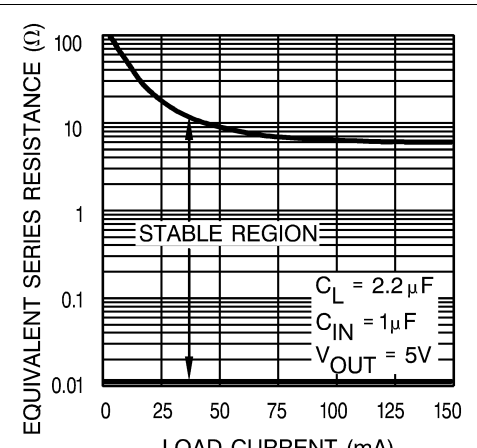

Figure 30. Output Capacitor ESR Range

Typical Characteristics (continued)



Figure 31. LP2951-N Input Pin Current vs Input Voltage

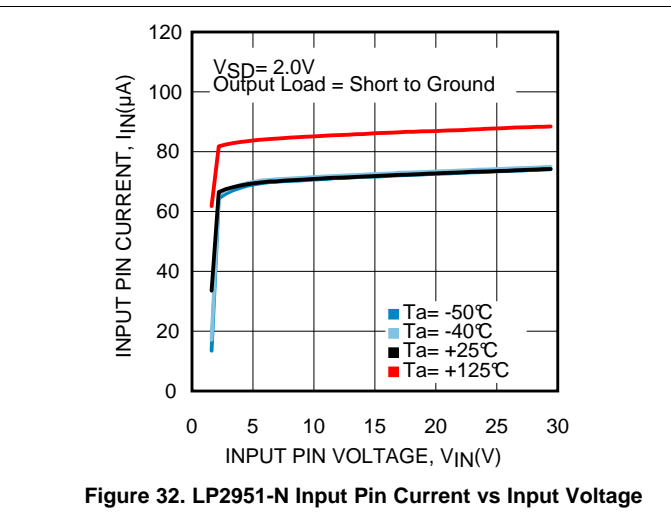

Figure 32. LP2951-N Input Pin Current vs Input Voltage

8 Detailed Description

8.1 Overview

The LP2950-N and LP2951-N are very high accuracy micro power voltage regulators with low quiescent current (75 μ A typical) and low dropout voltage (typical 40 mV at light loads and 380 mV at 100 mA). They are ideally suited for use in battery-powered systems.

The LP2950-N and LP2951-N block diagram contains several features, including:

- Very high accuracy 1.23-V reference;
- Fixed 5-V, 3-V, and 3.3-V versions; and
- Internal protection circuitry, such as foldback current limit, and thermal shutdown.

The LP2951-N VERSIONS ONLY:

- Fixed 5-V, 3-V, and 3.3-V versions and programmable output version from 1.24 V to 29 V with an external pair of resistors;
- Shutdown input, allowing turn off the regulator when the SHUTDOWN pin is pulled low; and
- Error flag output, which may be used for a power-on reset.

8.2 Functional Block Diagrams



Figure 33. LP2950-N Functional Block Diagram



Figure 34. LP2951-N Functional Block Diagram

8.3 Feature Description

8.3.1 Fixed Voltage Options and Programmable Voltage Version

The LP2950-N and LP2951-N provide 3 fixed output options: 3 V, 3.3 V, and 5 V. Please consult factory for custom voltages. In order to meet different application requirements, LP2951-N can also be used as a programmable voltage regulator, with an external resistors network; please refer to [Application and Implementation](#) for more details.

8.3.2 High Accuracy Output Voltage

With special careful design to minimize all contributions to the output voltage error, the LP2950-N/LP2951-N distinguished itself as a very high output voltage accuracy micro power LDO. This includes a tight initial tolerance (0.5% typical), extremely good load and line regulation (.05% typical) and a very low output voltage temperature coefficient, making the part an ideal a low-power voltage reference.

8.3.3 Low Dropout Voltage

Generally speaking, the dropout voltage often refers to the voltage difference between the input and output voltage ($V_{DO} = V_{IN} - V_{OUT}$), where the main current pass-FET is fully on in the ohmic region of operation and is characterized by the classic $R_{DS(ON)}$ of the FET. V_{DO} indirectly specifies a minimum input voltage above the nominal programmed output voltage at which the output voltage is expected to remain within its accuracy boundary.

8.3.4 Shutdown Mode

When the SHUTDOWN pin is pulled to high level, LP2951-N enters shutdown mode and a very low quiescent current is consumed. This function is designed for the application which needs a shutdown mode to effectively enhance battery life cycle.

8.3.5 Error Detection Comparator Output

The LP2951-N generates a logic low output whenever its output falls out of regulation by more than approximately 5%. Please refer to [Application and Implementation](#) for more details.

8.3.6 Internal Protection Circuitry

8.3.6.1 Short-Circuit Protection (Current Limit)

The internal current limit circuit is used to protect the LDO against high-load current faults or shorting events. The LDO is not designed to operate in a steady-state current limit. During a current-limit event, the LDO sources constant current. Therefore, the output voltage falls when load impedance decreases. Note also that if a current limit occurs and the resulting output voltage is low, excessive power may be dissipated across the LDO, resulting in a thermal shutdown of the output. A fold back feature limits the short-circuit current to protect the regulator from damage under all load conditions. If OUT is forced below 0 V before EN goes high and the load current required exceeds the fold back current limit, the device may not start up correctly.

8.3.6.2 Thermal Protection

The device contains a thermal shutdown protection circuit to turn off the output current when excessive heat is dissipated in the LDO. The thermal time-constant of the semiconductor die is fairly short, and thus the output cycles on and off at a high rate when thermal shutdown is reached until the power dissipation is reduced. The internal protection circuitry of the device is designed to protect against thermal overload conditions. The circuitry is not intended to replace proper heat sinking. Continuously running the device into thermal shutdown degrades its reliability.

8.3.7 Enhanced Stability

The LP2950-N and LP2951-N is designed specifically to work with ceramic output capacitors, utilizing circuitry which allows the regulator to be stable across the entire range of output current with an output capacitor whose ESR is as low as 6 mΩ. For output capacitor requirement, please refer to [Application and Implementation](#).

8.4 Device Functional Modes

8.4.1 Operation with $30\text{ V} \geq V_{\text{IN}} > V_{\text{OUT(TARGET)}} + 1\text{ V}$

The device operate if the input voltage is equal to, or exceeds $V_{\text{OUT(TARGET)}} + 1\text{ V}$. At input voltages below the minimum V_{IN} requirement, the devices do not operate correctly and output voltage may not reach target value.

8.4.2 Operation with Shutdown Control

If the voltage on the SHUTDOWN pin is higher than 1.3 V, the device is disabled. Decreasing shutdown below 0.7 V initiates the start-up sequence of the device.

9 Application and Implementation

NOTE

Information in the following applications sections is not part of the TI component specification, and TI does not warrant its accuracy or completeness. TI's customers are responsible for determining suitability of components for their purposes. Customers should validate and test their design implementation to confirm system functionality.

9.1 Application Information

The LP2950-N and LP2951-N are linear voltage regulator operating from 2.3 V to 30 V on the input and regulates voltages between 1.24 V to 29 V with 0.5% accuracy and 160 mA maximum outputs current. Efficiency is defined by the ratio of output voltage to input voltage because the LP2950-N and LP2951-N is a linear voltage regulator. To achieve high efficiency, the dropout voltage ($V_{IN} - V_{OUT}$) must be as small as possible, thus requiring a very low dropout LDO. Successfully implementing an LDO in an application depends on the application requirements. If the requirements are simply input voltage and output voltage, compliance specifications (such as internal power dissipation or stability) must be verified to ensure a solid design. If timing, start-up, noise, PSRR, or any other transient specification is required, the design becomes more challenging.

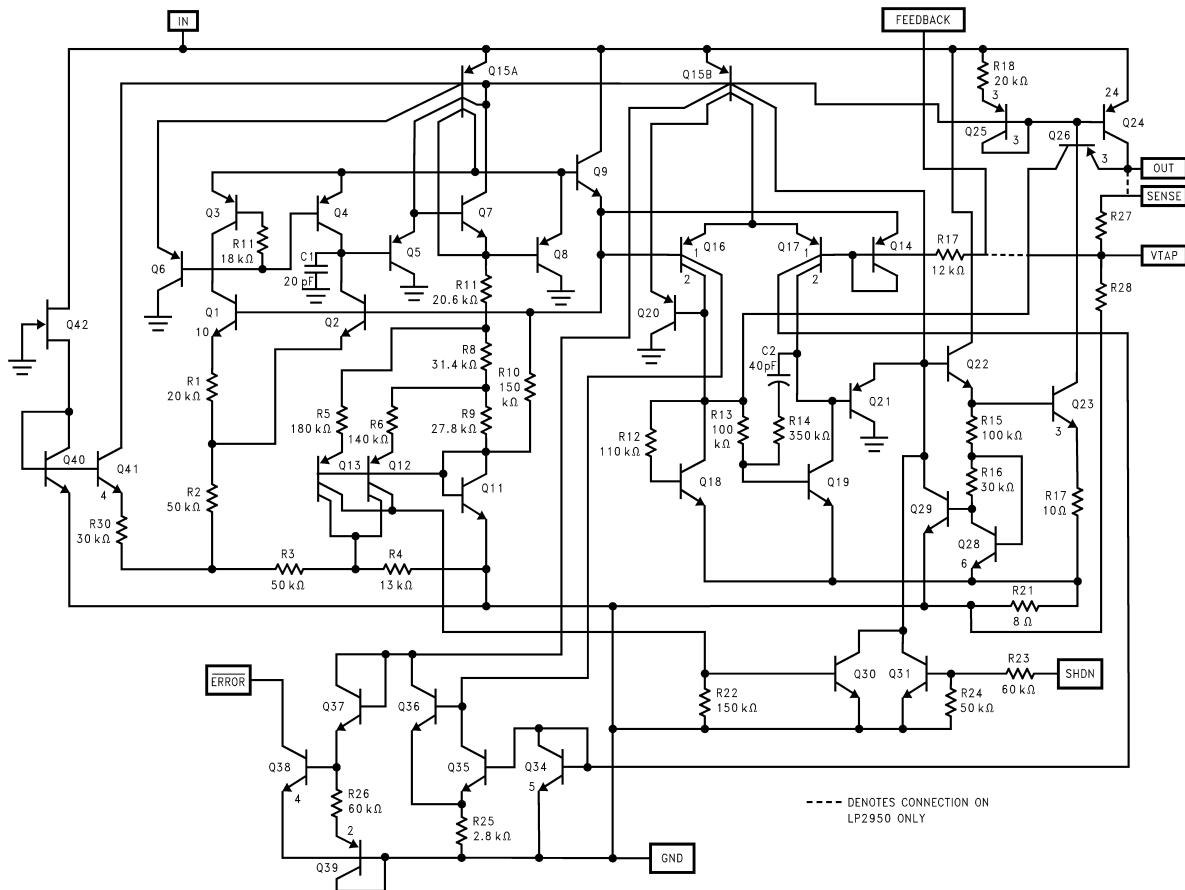

Figure 35. Schematic Diagram

9.2 Typical Applications

9.2.1 1-A Regulator with 1.2-V Dropout



Figure 36. 1-A Regulator with 1.2-V Dropout

9.2.1.1 Design Requirements

For this design example, use the parameters listed in Table 1 as the input parameters.

Table 1. Design Parameters

DESIGN PARAMETER	DESIGN REQUIREMENT
Input voltage	6.5 V, $\pm 10\%$, provided by the DC-DC converter switching at 1 MHz
Output voltage	5 V, $\pm 1\%$
Output current	100 mA (maximum), 1 mA (minimum)
RMS noise, 10 Hz to 100 kHz	$< 200 \mu\text{V}_{\text{RMS}}$
PSRR at 1 KHz	$> 50 \text{ dB}$

9.2.1.2 Detailed Design Procedure

At 100-mA loading, the dropout of the LP2950-N/LP2951-N has 600 mV maximum dropout over temperature, thus an 1500-mV headroom is sufficient for operation over both input and output voltage accuracy. The efficiency of the LP2950-N/LP2951-N in this configuration is $V_{\text{OUT}} / V_{\text{IN}} = 76.9\%$. To achieve the smallest form factor, the TO-92 package is selected. Input and output capacitors are selected in accordance with the Capacitor Recommendation section. Ceramic capacitances of 1 μF for the input and one 2.2- μF capacitors for the output are selected. With an efficiency of 73.3% and a 100-mA maximum load, the internal power dissipation is 150 mW, which corresponds to a 18.9°C junction temperature rise for the TO-92 package. With an 85°C maximum ambient temperature, the junction temperature is at 103.9°C. To minimize noise, a bypass capacitance (C_{BYPASS}) of 0.01- μF is selected between pin 7 to pin 1 for LP2951-N.

9.2.1.2.1 Output Capacitor Requirements

A 1- μF (or greater) capacitor is required between the output and ground for stability at output voltages of 5 V or higher. At lower output voltages, more capacitance is required (2.2 μF or more is recommended for 3-V and 3.3-V versions). Without this capacitor the device oscillates. Most types of tantalum or aluminum electrolytic work fine here; even film types work but are not recommended for reasons of cost. Many aluminum electrolytics have electrolytes that freeze at about -30°C , so solid tantalums are recommended for operation below -25°C . The important parameters of the capacitor are an ESR of about 5 Ω or less and a resonant frequency above 500 kHz. The value of this capacitor may be increased without limit.

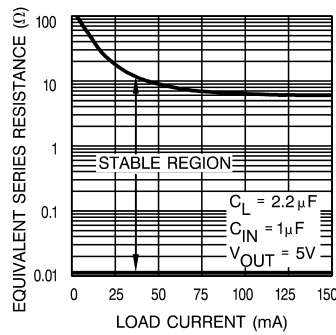

Figure 37. Output Capacitor ESR Range

The reason for the lower ESR limit is that the loop compensation of the feedback loop relies on the capacitance value and the ESR value of the output capacitor to provide the zero that gives added phase lead (See Figure 37).

$$f_z = (1 / (2 \times \pi \times C_{OUT} \times ESR)) \quad (1)$$

Using the 2.2 μF value from the *Output Capacitor ESR Range* curve (Figure 37), a useful range for f_z can be estimated:

$$f_{z(MIN)} = (1 / (2 \times \pi \times 2.2 \mu\text{F} \times 5 \Omega)) = 14.5 \text{ kHz} \quad (2)$$

$$f_{z(MAX)} = (1 / (2 \times \pi \times 2.2 \mu\text{F} \times 0.05 \Omega)) = 318 \text{ kHz} \quad (3)$$

For ceramic capacitors, the low ESR produces a zero at a frequency that is too high to be useful, so meaningful phase lead does not occur. A ceramic output capacitor can be used if a series resistance is added (recommended value of resistance about 0.1 Ω to 2 Ω) to simulate the needed ESR. Only X5R, X7R, or better, MLCC types should be used, and should have a DC voltage rating at least twice the $V_{OUT(NOM)}$ value.

At lower values of output current, less output capacitance is required for stability. The capacitor can be reduced to 0.33 μF for currents below 10 mA or 0.1 μF for currents below 1 mA. Using the adjustable versions at voltages below 5 V runs the error amplifier at lower gains so that *more* output capacitance is needed. For the worst-case situation of a 100-mA load at 1.23 V output (output shorted to Feedback) a 3.3- μF (or greater) capacitor should be used.

Unlike many other regulators, the LP2950-N remains stable and in regulation with no load in addition to the internal voltage divider. This is especially important in CMOS RAM keep-alive applications. When setting the output voltage of the LP2951-N versions with external resistors, a minimum load of 1 μA is recommended.

Applications having conditions that may drive the LP2950-N/51 into nonlinear operation require special consideration. Nonlinear operation occurs when the output voltage is held low enough to force the output stage into output current limiting while trying to pull the output voltage up to the regulated value. The internal loop response time controls how long it takes for the device to regain linear operation when the output has returned to the normal operating range. There are three significant nonlinear conditions that need to be considered, all can force the output stage into output current limiting mode, all can cause the output voltage to over-shoot with low value output capacitors when the condition is removed, and the recommended generic solution is to set the output capacitor to a value not less than 10 μF . Although the 10 μF value for C_{OUT} may not eliminate the output voltage over-shoot in all cases, it should lower it to acceptable levels (< 10% of $V_{OUT(NOM)}$) in the majority of cases. In all three of these conditions, applications with lighter load currents are more susceptible to output voltage over-shoot than applications with higher load currents.

1. At power-up, with the input voltage rising faster than output stage can charge the output capacitor.

$$V_{IN} t_{RISE(MIN)} > ((C_{OUT} / 100 \text{ mA}) \times \Delta V_{IN})$$

where

- $\Delta V_{IN} = V_{OUT(NOM)} + 1 \text{ V}$ (4)

2. Recovery from an output short circuit to ground condition.

$$C_{OUT(MIN)} \approx (160 \text{ mA} - I_{LOAD(NOM)}) / ((V_{OUT(NOM)} / 10) / 25 \mu\text{s}) \quad (5)$$

3. Toggling the LP2951-N SHUTDOWN pin from high (OFF) to low (ON).

$$C_{OUT(MIN)} \approx (160 \text{ mA} - I_{LOAD(NOM)}) / ((V_{OUT(NOM)} / 10) / 25 \mu\text{s}) \quad (6)$$



Figure 38. LP2951-N Enable Transient

9.2.1.2.2 Input Capacitor Requirements

A minimum 1 μF tantalum, ceramic or aluminum electrolytic capacitor should be placed from the LP2950-N/LP2951-N input pin to ground if there is more than 10 inches of wire between the input and the AC filter capacitor or if a battery is used as the input.

9.2.1.2.3 Error Detection Comparator Output

The comparator produces a logic low output whenever the LP2951-N output falls out of regulation by more than approximately 5%. This figure is the comparator's built-in offset of about 60 mV divided by the 1.235 reference voltage. (Refer to the block diagram in the front of the datasheet.) This trip level remains "5% below normal" regardless of the programmed output voltage of the 2951. For example, the error flag trip level is typically 4.75 V for a 5-V output or 11.4 V for a 12-V output. The out of regulation condition may be due either to low input voltage, current limiting, or thermal limiting.

Figure 39 below gives a timing diagram depicting the $\overline{\text{ERROR}}$ signal and the regulated output voltage as the LP2951-N input is ramped up and down. For 5 V versions, the $\overline{\text{ERROR}}$ signal becomes valid (low) at about 1.3-V input. It goes high at about 5-V input (the input voltage at which $V_{\text{OUT}} = 4.75 \text{ V}$). Because the LP2951-N dropout voltage is load-dependent (see curve in typical performance characteristics), the **input** voltage trip point (about 5 V) varies with the load current. The **output** voltage trip point (approx. 4.75 V) does not vary with load.

The error comparator has an open-collector output which requires an external pull up resistor. This resistor may be returned to the output or some other supply voltage depending on system requirements. In determining a value for this resistor, note that while the output is rated to sink 400 μA , this sink current adds to battery drain in a low battery condition. Suggested values range from 100 k to 1 M Ω . The resistor is not required if this output is unused.



*When $V_{\text{IN}} \leq 1.3 \text{ V}$, the error flag pin becomes a high impedance, and the error flag voltage rises to its pullup voltage. Using V_{OUT} as the pullup voltage (see Figure 40), rather than an external 5-V source, keeps the error flag voltage under 1.2 V (typical) in this condition. The user may wish to divide down the error flag voltage using equal-value resistors (10 k Ω suggested), to ensure a low-level logic signal during any fault condition, while still allowing a valid high logic level during normal operation.

Figure 39. $\overline{\text{ERROR}}$ Output Timing

9.2.1.2.4 Programming the Output Voltage (LP2951-N)

The LP2951-N may be pin-strapped for the nominal fixed output voltage using its internal voltage divider by tying the output and sense pins together, and also tying the FEEDBACK and VTAP pins together. Alternatively, it may be programmed for any output voltage between its 1.235-V reference and its 30-V maximum rating. As seen in Figure 40, an external pair of resistors is required.

The complete equation for the output voltage is

$$V_{OUT} = V_{REF} \cdot \left(1 + \frac{R_1}{R_2} \right) + I_{FB}R_1$$

where

- V_{REF} is the nominal 1.235-V reference voltage and I_{FB} is the FEEDBACK pin bias current, nominally -20 nA (7)

The minimum recommended load current of 1 μ A forces an upper limit of 1.2 M Ω on the value of R_2 , if the regulator must work with no load (a condition often found in CMOS in standby). I_{FB} produces a 2% typical error in V_{OUT} which may be eliminated at room temperature by trimming R_1 . For better accuracy, choosing $R_2 = 100$ k Ω reduces this error to 0.17% while increasing the resistor program current to 12 μ A. Because the LP2951-N typically draws 60 μ A at no load with pin 2 open-circuited, this is a small price to pay.

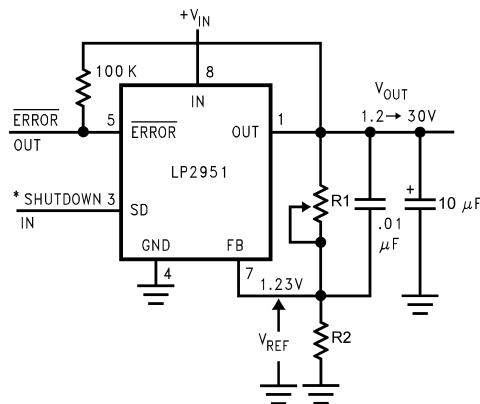

$$V_{out} = V_{Ref} \left(1 + \frac{R_1}{R_2} \right)$$

*Drive with TTL-high to shut down. Ground or leave open if shutdown feature is not to be used.

Note: Pins 2 and 6 are left open.

Figure 40. Adjustable Regulator

Stray capacitance to the LP2951-N FEEDBACK pin can cause instability. This may especially be a problem when using high value external resistors to set the output voltage. Adding a 100-pF capacitor between the OUT pin and the FEEDBACK pin, and increasing the output capacitor to at least 3.3 μ F, fixes this problem.

9.2.1.2.5 Reducing Output Noise

In reference applications it may be advantageous to reduce the AC noise present at the output. One method is to reduce the regulator bandwidth by increasing the size of the output capacitor. This is the only way noise can be reduced on the 3-lead LP2950-N but is relatively inefficient, as increasing the capacitor from 1 μ F to 220 μ F only decreases the noise from 430 μ V_{RMS} to 160 μ V_{RMS} for a 100-kHz bandwidth at 5-V output.

Noise can be reduced fourfold by a bypass capacitor across R_1 , because it reduces the high frequency gain from 4 to unity. Pick

$$C_{BYPASS} \cong \frac{1}{2\pi R_1 \bullet 200 \text{ Hz}} \tag{8}$$

or about 0.01 μ F. When doing this, the output capacitor must be increased to 3.3 μ F to maintain stability. These changes reduce the output noise from 430 μ V to 100 μ V rms for a 100-kHz bandwidth at 5-V output. With the bypass capacitor added, noise no longer scales with output voltage so that improvements are more dramatic at higher output voltages.

9.2.1.3 Application Curves



9.2.2 300-mA Regulator with 0.75-V Dropout

In Figure 44, by paralleling the LP2951 together with 2x2N5432 (150-mA N channel JFET), a user can get a higher output current capability around 300 mA.



Figure 44. 300-mA Regulator with 0.75-V Dropout

9.2.3 Wide Input Voltage Range Current Limiter

The LP2951 can be used as a 160-mA current limiter as Figure 45. When FB is connected to ground, the pass element is fully turned on and out voltage will be close to input voltage. Input-output voltage ranges from 40 mV to 400 mV, depending on load current.



*Minimum input-output voltage ranges from 40 mV to 400 mV, depending on load current. Current limit is typically 160 mA.

Figure 45. Wide Input Voltage Range Current Limiter

9.2.4 Low Drift Current Source

The LP2951 can be used as a low drift current source as [Figure 46](#) shows. By connected V_{out} to FB, V_{out} will be regulated at 1.235 V, and current consumption at R is $I_L = 1.23/R$.



Figure 46. Low Drift Current Source

9.2.5 5-V Current Limiter

The LP2950 internal current limit function can be leveraged to build 5-V current limiter as [Figure 47](#) shows. The minimum input-output voltage ranges from 40 mV to 400 mV, depending on load current. Current limit is typically 160 mA.



*Minimum input-output voltage ranges from 40 mV to 400 mV, depending on load current. Current limit is typically 160 mA.

Figure 47. 5-V Current Limiter

9.2.6 Regulator with Early Warning and Auxiliary Output

The LP2951 can be used to build a Regulator with early warning and auxiliary output as Figure 48 shows. it has below features:

- Early warning flag on low input voltage
- Main output latches off at lower input voltages
- Battery backup on auxiliary output
- Operation: V_{OUT} of regulator 1 is programmed one diode drop above 5 V. Its error flag becomes active when $V_{IN} \leq 5.7$ V. When V_{IN} drops below 5.3 V, the error flag of regulator 2 becomes active and via Q1 latches the main output off. When V_{IN} again exceeds 5.7 V regulator 1 is back in regulation and the early warning signal rises, unlatching regulator 2 via D3.



Figure 48. Regulator With Early Warning and Auxiliary Output

9.2.7 Latch Off When Error Flag Occurs

As Figure 49 presents, a latch off when error flag occurs circuit works in below two mode:

When output is within $\pm 95\%$ of V_{OUT} option, the error flag pin keep output high, which turns off PNP bipolar and pulls SD pin to low, then the LP2951 keeps output regulated voltage.

When output drop to less than 95% of V_{OUT} option, it triggers error flag output a low voltage, which turns on PNP bipolar and pulls SD pin to high, then the device enters shutdown mode and turns off output voltage. During a shutdown sequence, the \overline{ERROR} pin continues output low, and the LP2951 device latches in shutdown mode.



Figure 49. Latch Off When Error Flag Occurs

9.2.8 2-A Low Dropout Regulator

As Figure 50 shows, the 2-A low dropout regulator has below features:

$$V_{out} = 1.23V \left(1 + \frac{R_1}{R_2} \right)$$

For 5 V_{OUT}, use internal resistors. Wire pin 6 to pin 7 and wire pin 2 to + V_{OUT} bus.

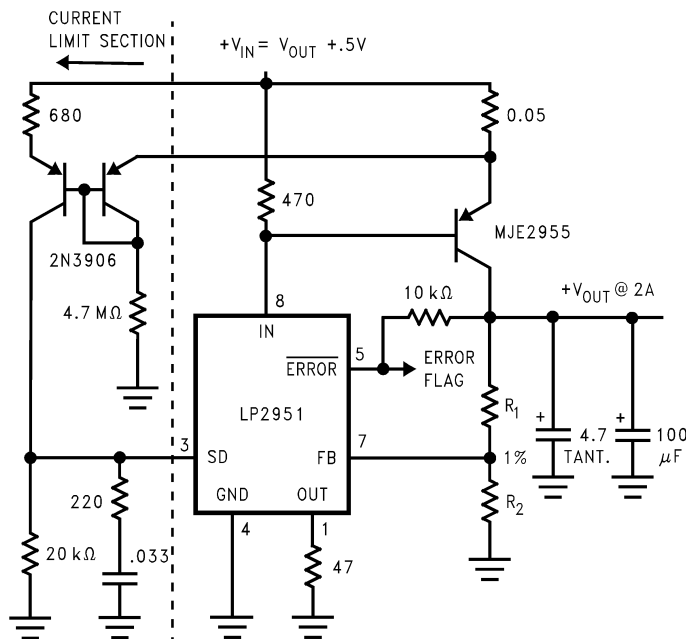

Figure 50. 2-A Low Dropout Regulator

9.2.9 5-V Regulator with 2.5-V Sleep Function

In Figure 51, the 5-V regulator with 2.5-V sleep function works in below mode:

When sleep input is low, C-MOS output a high voltage and 2N3906 is off, then $V_{out} = (1 + 300\text{ K}\Omega/100\text{ K}\Omega) \times V_{FB} \approx 5\text{ V}$

when sleep input is high, C-MOS output a low voltage, turns on 2N3906, then 200-KΩ resistor is bypassed from circuit, and $V_{OUT} = (1+100\text{ K}\Omega/100\text{ K}\Omega) \times V_{FB} \approx 2.5\text{ V}$.



*High input lowers V_{out} to 2.5 V.

Figure 51. 5-V Regulator with 2.5-V Sleep Function

9.2.10 Open Circuit Detector for 4 → 20-mA Current Loop

Figure 52 shows the open circuit detector for 4 → 20-mA current loop. The circuit outputs a high level while input current is less than 3.5 mA.



Figure 52. Open Circuit Detector for 4 → 20-mA Current Loop

9.2.11 Regulator with State-of-Charge Indicator

In Figure 53, the LP339, a quad comparator, is used to indicate battery voltage state. The comparator's negative input voltage is equal to the LP2951 1.235-V feedback voltage. By adjusting R3, we can adjust positive input voltage of C1~C3 to target value.

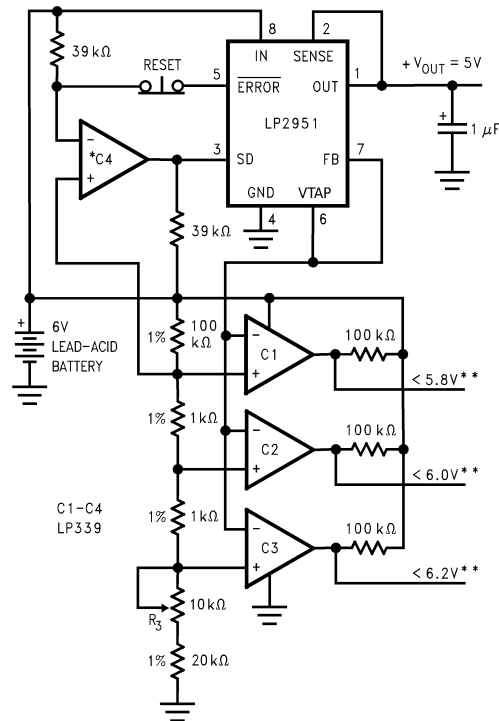

*Optional latch off when drop out occurs. Adjust R3 for C2 Switching when V_{in} is 6 V.

**Outputs go low when V_{in} drops below designated thresholds.

Figure 53. Regulator with State-of-Charge Indicator

9.2.12 Low Battery Disconnect

In Figure 54, a band-gap voltage reference LM385 is used to generate shutdown signal, when $V_{in} < 5.5$ V, the LP2951 turns off and turns on again when $V_{in} > 6$ V.



For values shown, regulator shuts down when $V_{in} < 5.5$ V and turns on again at 6 V. Current drain in disconnected mode is approximately 150 μ A.

*Sets disconnect voltage.

**Sets disconnect hysteresis.

Figure 54. Low Battery Disconnect

9.2.13 System Overtemperature Protection Circuit

In Figure 55, temperature sensors LM34/35's output voltage is linearly proportional to the Celsius (Centigrade) temperature.

At room temperature, LM34/35's output voltage is lower than 1.235-V feedback voltage, the internal pass transistor fully turns on, and the LP2951 output voltage is close to V_{in} .

When ambient temperature raise higher than protection target, LM34/35's output voltage is higher than 1.235-V feedback voltage, the internal pass transistor turns off, and the LP2951 output goes off.

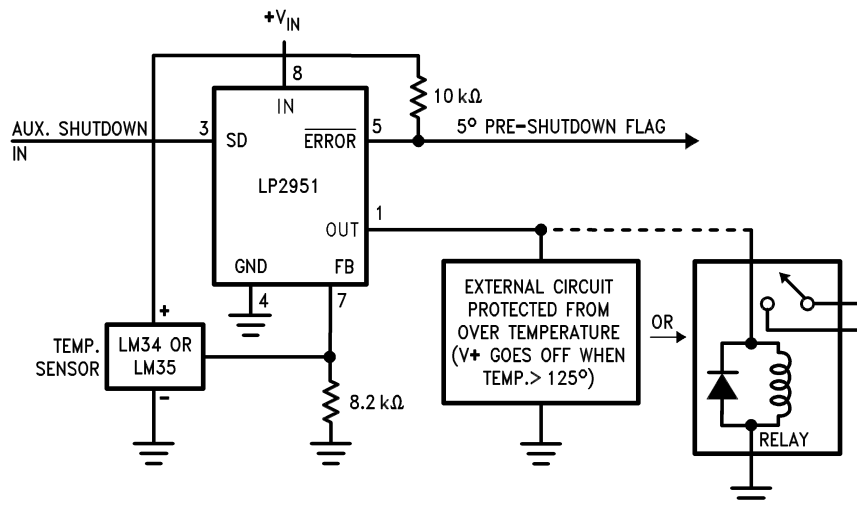

LM34 for 125°F shutdown

LM35 for 125°C shutdown

Figure 55. System Overtemperature Protection Circuit

10 Power Supply Recommendations

The LP2950-N and LP2951-N are designed to operate from an input voltage supply range between 2.3 V and 30 V. The input voltage range provides adequate headroom in order for the device to have a regulated output. This input supply must be well regulated. If the input supply is noisy, additional input capacitors with low ESR can help improve the output noise performance.

11 Layout

11.1 Layout Guidelines

For best overall performance, place all circuit components on the same side of the circuit board and as near as practical to the respective LDO pin connections. Place ground return connections to the input and output capacitor, and to the LDO ground pin as close to each other as possible, connected by a wide, component-side, copper surface. The use of vias and long traces to create LDO circuit connections is strongly discouraged and negatively affects system performance. This grounding and layout scheme minimizes inductive parasitics, and thereby reduces load-current transients, minimizes noise, and increases circuit stability.

A ground reference plane is also recommended and is either embedded in the PCB itself or located on the bottom side of the PCB opposite the components. This reference plane serves to assure accuracy of the output voltage, shield noise, and behaves similar to a thermal plane to spread (or sink) heat from the LDO device. In most applications, this ground plane is necessary to meet thermal requirements.

11.2 Layout Example

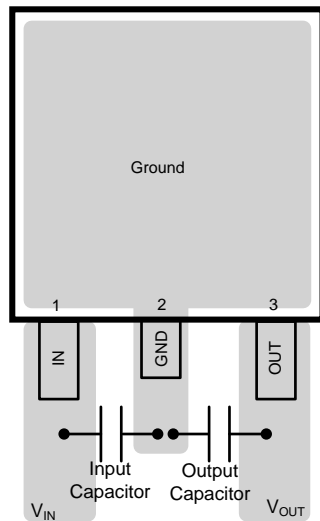

Figure 56. LP2950 Board Layout

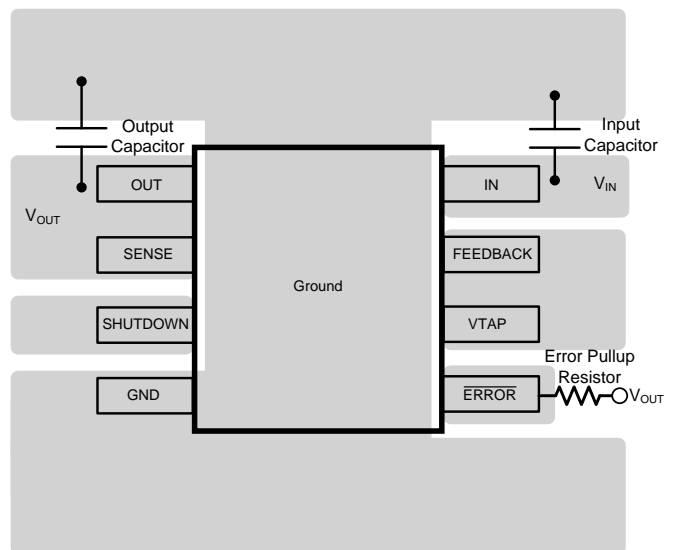

Figure 57. LP2951 VSSOP Board Layout

Layout Example (continued)

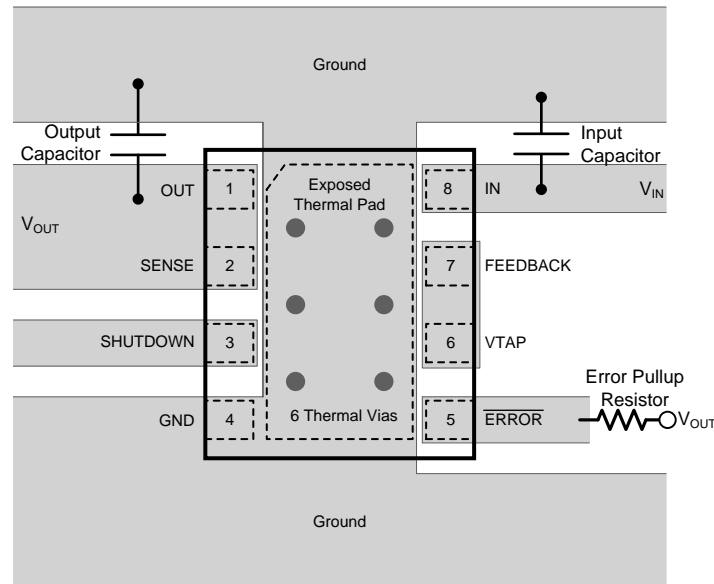

Figure 58. LP2951 WSON Board Layout

11.3 WSON Mounting

The NGT (no pullback) 8-lead WSON package requires specific mounting techniques which are detailed in [AN-1187 Leadless Leadframe Package \(LLP\)](#). Referring to the PCB Design Recommendations section, note that the pad style which should be used with the WSON package is the NSMD (non-solder mask defined) type. Additionally, TI recommends that the PCB terminal pads to be 0.2 mm longer than the package pads to create a solder fillet to improve reliability and inspection.

The thermal dissipation of the WSON package is directly related to the printed circuit board construction and the amount of additional copper area connected to the DAP.

For the LP2951-N in the NGT 8-lead WSON package, the junction-to-case thermal rating, $R_{\theta JC}$, is 35°C/W, where the case is the bottom of the package at the center of the DAP.

The DAP (exposed pad) on the bottom of the WSON package is connected to the die substrate with a conductive die attach adhesive. The DAP has no direct electrical (wire) connection to any of the eight pins. There is a parasitic PN junction between the die substrate and the device ground. As such, it is strongly recommend that the DAP be connected directly to the ground at device lead 4 (that is, GND). Alternately, but not recommended, the DAP may be left floating (that is, no electrical connection). The DAP must not be connected to any potential other than ground.

12 Device and Documentation Support

12.1 Documentation Support

12.1.1 Related Documentation

For related documentation, see the following:

[AN-1187 Leadless Leadframe Package \(LLP\)](#)

12.2 Related Links

[Table 2](#) lists quick access links. Categories include technical documents, support and community resources, tools and software, and quick access to sample or buy.

Table 2. Related Links

PARTS	PRODUCT FOLDER	SAMPLE & BUY	TECHNICAL DOCUMENTS	TOOLS & SOFTWARE	SUPPORT & COMMUNITY
LP2950-N	Click here	Click here	Click here	Click here	Click here
LP2951-N	Click here	Click here	Click here	Click here	Click here

12.3 Community Resources

The following links connect to TI community resources. Linked contents are provided "AS IS" by the respective contributors. They do not constitute TI specifications and do not necessarily reflect TI's views; see TI's [Terms of Use](#).

TI E2E™ Online Community *TI's Engineer-to-Engineer (E2E) Community*. Created to foster collaboration among engineers. At [e2e.ti.com](#), you can ask questions, share knowledge, explore ideas and help solve problems with fellow engineers.

Design Support *TI's Design Support* Quickly find helpful E2E forums along with design support tools and contact information for technical support.

12.4 Trademarks

E2E is a trademark of Texas Instruments.
All other trademarks are the property of their respective owners.

12.5 Electrostatic Discharge Caution



These devices have limited built-in ESD protection. The leads should be shorted together or the device placed in conductive foam during storage or handling to prevent electrostatic damage to the MOS gates.

12.6 Glossary

[SLYZ022](#) — *TI Glossary*.

This glossary lists and explains terms, acronyms, and definitions.

13 Mechanical, Packaging, and Orderable Information

The following pages include mechanical, packaging, and orderable information. This information is the most current data available for the designated devices. This data is subject to change without notice and revision of this document. For browser-based versions of this data sheet, refer to the left-hand navigation.

PACKAGING INFORMATION

Orderable Device	Status (1)	Package Type	Package Drawing	Pins	Package Qty	Eco Plan (2)	Lead finish/ Ball material (6)	MSL Peak Temp (3)	Op Temp (°C)	Device Marking (4/5)	Samples
LP2950ACZ-3.0/NOPB	ACTIVE	TO-92	LP	3	1800	RoHS & Green	Call TI	N / A for Pkg Type	-40 to 125	2950A CZ3.0	Samples
LP2950ACZ-3.3/NOPB	ACTIVE	TO-92	LP	3	1800	RoHS & Green	Call TI	N / A for Pkg Type	-40 to 125	2950A CZ3.3	Samples
LP2950ACZ-5.0/LFT1	ACTIVE	TO-92	LP	3	2000	RoHS & Green	SN	N / A for Pkg Type		2950A CZ5.0	Samples
LP2950ACZ-5.0/LFT3	ACTIVE	TO-92	LP	3	2000	RoHS & Green	SN	N / A for Pkg Type		2950A CZ5.0	Samples
LP2950ACZ-5.0/LFT7	ACTIVE	TO-92	LP	3	2000	RoHS & Green	Call TI	N / A for Pkg Type		2950A CZ5.0	Samples
LP2950ACZ-5.0/NOPB	ACTIVE	TO-92	LP	3	1800	RoHS & Green	Call TI	N / A for Pkg Type	-40 to 125	2950A CZ5.0	Samples
LP2950CDT-3.0/NOPB	ACTIVE	TO-252	NDP	3	75	RoHS & Green	SN	Level-2-260C-1 YEAR	-40 to 125	LP2950 CDT-3.0	Samples
LP2950CDT-3.3/NOPB	ACTIVE	TO-252	NDP	3	75	RoHS & Green	SN	Level-2-260C-1 YEAR	-40 to 125	LP2950 CDT-3.3	Samples
LP2950CDT-5.0/NOPB	ACTIVE	TO-252	NDP	3	75	RoHS & Green	SN	Level-2-260C-1 YEAR	-40 to 125	LP2950 CDT-5.0	Samples
LP2950CDTX-3.0/NOPB	ACTIVE	TO-252	NDP	3	2500	RoHS & Green	SN	Level-2-260C-1 YEAR	-40 to 125	LP2950 CDT-3.0	Samples
LP2950CDTX-3.3/NOPB	ACTIVE	TO-252	NDP	3	2500	RoHS & Green	SN	Level-2-260C-1 YEAR	-40 to 125	LP2950 CDT-3.3	Samples
LP2950CDTX-5.0/NOPB	ACTIVE	TO-252	NDP	3	2500	RoHS & Green	SN	Level-2-260C-1 YEAR	-40 to 125	LP2950 CDT-5.0	Samples
LP2950CZ-3.0/NOPB	ACTIVE	TO-92	LP	3	1800	RoHS & Green	Call TI	N / A for Pkg Type	-40 to 125	2950 CZ3.0	Samples
LP2950CZ-3.3/LFT3	ACTIVE	TO-92	LP	3	2000	RoHS & Green	SN	N / A for Pkg Type		2950 CZ3.3	Samples
LP2950CZ-3.3/NOPB	ACTIVE	TO-92	LP	3	1800	RoHS & Green	Call TI	N / A for Pkg Type	-40 to 125	2950 CZ3.3	Samples
LP2950CZ-5.0/LFT1	ACTIVE	TO-92	LP	3	2000	RoHS & Green	SN	N / A for Pkg Type		2950 CZ5.0	Samples
LP2950CZ-5.0/LFT3	ACTIVE	TO-92	LP	3	2000	RoHS & Green	SN	N / A for Pkg Type		2950	Samples

Orderable Device	Status (1)	Package Type	Package Drawing	Pins	Package Qty	Eco Plan (2)	Lead finish/ Ball material (6)	MSL Peak Temp (3)	Op Temp (°C)	Device Marking (4/5)	Samples
LP2950CZ-5.0/LFT7	ACTIVE	TO-92	LP	3	2000	RoHS & Green	Call TI	N / A for Pkg Type		CZ5.0 2950 CZ5.0	Samples
LP2950CZ-5.0/NOPB	ACTIVE	TO-92	LP	3	1800	RoHS & Green	Call TI	N / A for Pkg Type	-40 to 125	2950 CZ5.0	Samples
LP2951ACM-3.0/NOPB	ACTIVE	SOIC	D	8	95	RoHS & Green	NIPDAU SN	Level-1-260C-UNLIM	-40 to 125	2951A CM30C	Samples
LP2951ACM-3.3/NOPB	ACTIVE	SOIC	D	8	95	RoHS & Green	Call TI SN	Level-1-260C-UNLIM	-40 to 125	2951A (CM33>D, CM33C)	Samples
LP2951ACM/NOPB	ACTIVE	SOIC	D	8	95	RoHS & Green	Call TI SN	Level-1-260C-UNLIM	-40 to 125	2951 ACM>D	Samples
LP2951ACMM-3.0/NOPB	ACTIVE	VSSOP	DGK	8	1000	RoHS & Green	Call TI SN	Level-1-260C-UNLIM	-40 to 125	L0BA	Samples
LP2951ACMM-3.3/NOPB	ACTIVE	VSSOP	DGK	8	1000	RoHS & Green	SN	Level-1-260C-UNLIM	-40 to 125	L0CA	Samples
LP2951ACMM/NOPB	ACTIVE	VSSOP	DGK	8	1000	RoHS & Green	SN	Level-1-260C-UNLIM	-40 to 125	L0DA	Samples
LP2951ACMMX-3.0/NOPB	ACTIVE	VSSOP	DGK	8	3500	RoHS & Green	SN	Level-1-260C-UNLIM	-40 to 125	L0BA	Samples
LP2951ACMMX-3.3/NOPB	ACTIVE	VSSOP	DGK	8	3500	RoHS & Green	SN	Level-1-260C-UNLIM	-40 to 125	L0CA	Samples
LP2951ACMMX/NOPB	ACTIVE	VSSOP	DGK	8	3500	RoHS & Green	SN	Level-1-260C-UNLIM	-40 to 125	L0DA	Samples
LP2951ACMX-3.0/NOPB	ACTIVE	SOIC	D	8	2500	RoHS & Green	Call TI SN	Level-1-260C-UNLIM	-40 to 125	2951A CM30C	Samples
LP2951ACMX-3.3/NOPB	ACTIVE	SOIC	D	8	2500	RoHS & Green	Call TI SN	Level-1-260C-UNLIM	-40 to 125	2951A (CM33>D, CM33C)	Samples
LP2951ACMX/NOPB	ACTIVE	SOIC	D	8	2500	RoHS & Green	Call TI SN	Level-1-260C-UNLIM	-40 to 125	2951 (ACM>D, ACMC)	Samples
LP2951ACN/NOPB	ACTIVE	PDIP	P	8	40	RoHS & Green	NIPDAU	Level-1-NA-UNLIM	-40 to 125	LP 2951ACN	Samples
LP2951ACSD/NOPB	ACTIVE	WSON	NGT	8	1000	RoHS & Green	NIPDAU SN	Level-1-260C-UNLIM	-40 to 125	2951AC	Samples
LP2951ACSDX-3.3/NOPB	ACTIVE	WSON	NGT	8	4500	RoHS & Green	SN	Level-1-260C-UNLIM	-40 to 125	51AC33	Samples
LP2951ACSDX/NOPB	ACTIVE	WSON	NGT	8	4500	RoHS & Green	SN	Level-1-260C-UNLIM	-40 to 125	2951AC	Samples
LP2951CM-3.0/NOPB	ACTIVE	SOIC	D	8	95	RoHS & Green	NIPDAU SN	Level-1-260C-UNLIM	-40 to 125	2951C	Samples

Orderable Device	Status (1)	Package Type	Package Drawing	Pins	Package Qty	Eco Plan (2)	Lead finish/ Ball material (6)	MSL Peak Temp (3)	Op Temp (°C)	Device Marking (4/5)	Samples
										M30C	
LP2951CM-3.3/NOPB	ACTIVE	SOIC	D	8	95	RoHS & Green	NIPDAU SN	Level-1-260C-UNLIM	-40 to 125	2951C M33>D	Samples
LP2951CM/NOPB	ACTIVE	SOIC	D	8	95	RoHS & Green	NIPDAU SN	Level-1-260C-UNLIM	-40 to 125	2951 (CM>D, CMC)	Samples
LP2951CMM-3.0/NOPB	ACTIVE	VSSOP	DGK	8	1000	RoHS & Green	SN	Level-1-260C-UNLIM	-40 to 125	L0BB	Samples
LP2951CMM-3.3/NOPB	ACTIVE	VSSOP	DGK	8	1000	RoHS & Green	SN	Level-1-260C-UNLIM	-40 to 125	L0CB	Samples
LP2951CMM/NOPB	ACTIVE	VSSOP	DGK	8	1000	RoHS & Green	SN	Level-1-260C-UNLIM	-40 to 125	L0DB	Samples
LP2951CMMX-3.0/NOPB	ACTIVE	VSSOP	DGK	8	3500	RoHS & Green	SN	Level-1-260C-UNLIM	-40 to 125	L0BB	Samples
LP2951CMMX-3.3/NOPB	ACTIVE	VSSOP	DGK	8	3500	RoHS & Green	SN	Level-1-260C-UNLIM	-40 to 125	L0CB	Samples
LP2951CMMX/NOPB	ACTIVE	VSSOP	DGK	8	3500	RoHS & Green	SN	Level-1-260C-UNLIM	-40 to 125	L0DB	Samples
LP2951CMX-3.0/NOPB	ACTIVE	SOIC	D	8	2500	RoHS & Green	NIPDAU SN	Level-1-260C-UNLIM	-40 to 125	2951C M30C	Samples
LP2951CMX-3.3/NOPB	ACTIVE	SOIC	D	8	2500	RoHS & Green	NIPDAU SN	Level-1-260C-UNLIM	-40 to 125	2951C (M33>D, M33C)	Samples
LP2951CMX/NOPB	ACTIVE	SOIC	D	8	2500	RoHS & Green	NIPDAU SN	Level-1-260C-UNLIM	-40 to 125	2951 (CM, CM>D)	Samples
LP2951CN/NOPB	ACTIVE	PDIP	P	8	40	RoHS & Green	NIPDAU	Level-1-NA-UNLIM	-40 to 125	LP 2951CN	Samples
LP2951CSD-3.0/NOPB	ACTIVE	WSO	NGT	8	1000	RoHS & Green	NIPDAU SN	Level-1-260C-UNLIM	-40 to 125	51AC30B	Samples
LP2951CSD-3.3/NOPB	ACTIVE	WSO	NGT	8	1000	RoHS & Green	SN	Level-1-260C-UNLIM	-40 to 125	51AC33B	Samples
LP2951CSD/NOPB	ACTIVE	WSO	NGT	8	1000	RoHS & Green	NIPDAU SN	Level-1-260C-UNLIM	-40 to 125	2951ACB	Samples
LP2951CSDX-3.3/NOPB	ACTIVE	WSO	NGT	8	4500	RoHS & Green	SN	Level-1-260C-UNLIM	-40 to 125	51AC33B	Samples
LP2951CSDX/NOPB	ACTIVE	WSO	NGT	8	4500	RoHS & Green	NIPDAU SN	Level-1-260C-UNLIM	-40 to 125	2951ACB	Samples

(1) The marketing status values are defined as follows:

ACTIVE: Product device recommended for new designs.

LIFEBUY: TI has announced that the device will be discontinued, and a lifetime-buy period is in effect.

NRND: Not recommended for new designs. Device is in production to support existing customers, but TI does not recommend using this part in a new design.

PREVIEW: Device has been announced but is not in production. Samples may or may not be available.

OBSOLETE: TI has discontinued the production of the device.

⁽²⁾ **RoHS:** TI defines "RoHS" to mean semiconductor products that are compliant with the current EU RoHS requirements for all 10 RoHS substances, including the requirement that RoHS substance do not exceed 0.1% by weight in homogeneous materials. Where designed to be soldered at high temperatures, "RoHS" products are suitable for use in specified lead-free processes. TI may reference these types of products as "Pb-Free".

RoHS Exempt: TI defines "RoHS Exempt" to mean products that contain lead but are compliant with EU RoHS pursuant to a specific EU RoHS exemption.

Green: TI defines "Green" to mean the content of Chlorine (Cl) and Bromine (Br) based flame retardants meet JS709B low halogen requirements of ≤ 1000 ppm threshold. Antimony trioxide based flame retardants must also meet the ≤ 1000 ppm threshold requirement.

⁽³⁾ MSL, Peak Temp. - The Moisture Sensitivity Level rating according to the JEDEC industry standard classifications, and peak solder temperature.

⁽⁴⁾ There may be additional marking, which relates to the logo, the lot trace code information, or the environmental category on the device.

⁽⁵⁾ Multiple Device Markings will be inside parentheses. Only one Device Marking contained in parentheses and separated by a "~" will appear on a device. If a line is indented then it is a continuation of the previous line and the two combined represent the entire Device Marking for that device.

⁽⁶⁾ Lead finish/Ball material - Orderable Devices may have multiple material finish options. Finish options are separated by a vertical ruled line. Lead finish/Ball material values may wrap to two lines if the finish value exceeds the maximum column width.

Important Information and Disclaimer: The information provided on this page represents TI's knowledge and belief as of the date that it is provided. TI bases its knowledge and belief on information provided by third parties, and makes no representation or warranty as to the accuracy of such information. Efforts are underway to better integrate information from third parties. TI has taken and continues to take reasonable steps to provide representative and accurate information but may not have conducted destructive testing or chemical analysis on incoming materials and chemicals. TI and TI suppliers consider certain information to be proprietary, and thus CAS numbers and other limited information may not be available for release.

In no event shall TI's liability arising out of such information exceed the total purchase price of the TI part(s) at issue in this document sold by TI to Customer on an annual basis.

OTHER QUALIFIED VERSIONS OF LP2951-N :

- Automotive : [LP2951-Q1](#)

NOTE: Qualified Version Definitions:

- Automotive - Q100 devices qualified for high-reliability automotive applications targeting zero defects

TAPE AND REEL INFORMATION



QUADRANT ASSIGNMENTS FOR PIN 1 ORIENTATION IN TAPE



*All dimensions are nominal

Device	Package Type	Package Drawing	Pins	SPQ	Reel Diameter (mm)	Reel Width W1 (mm)	A0 (mm)	B0 (mm)	K0 (mm)	P1 (mm)	W (mm)	Pin1 Quadrant
LP2950CDTX-3.0/NOPB	TO-252	NDP	3	2500	330.0	16.4	6.9	10.5	2.7	8.0	16.0	Q2
LP2950CDTX-3.3/NOPB	TO-252	NDP	3	2500	330.0	16.4	6.9	10.5	2.7	8.0	16.0	Q2
LP2950CDTX-5.0/NOPB	TO-252	NDP	3	2500	330.0	16.4	6.9	10.5	2.7	8.0	16.0	Q2
LP2951ACMM-3.0/NOPB	VSSOP	DGK	8	1000	178.0	12.4	5.3	3.4	1.4	8.0	12.0	Q1
LP2951ACMM-3.3/NOPB	VSSOP	DGK	8	1000	178.0	12.4	5.3	3.4	1.4	8.0	12.0	Q1
LP2951ACMM/NOPB	VSSOP	DGK	8	1000	178.0	12.4	5.3	3.4	1.4	8.0	12.0	Q1
LP2951ACMMX-3.0/NOPB	VSSOP	DGK	8	3500	330.0	12.4	5.3	3.4	1.4	8.0	12.0	Q1
LP2951ACMMX-3.3/NOPB	VSSOP	DGK	8	3500	330.0	12.4	5.3	3.4	1.4	8.0	12.0	Q1
LP2951ACMMX/NOPB	VSSOP	DGK	8	3500	330.0	12.4	5.3	3.4	1.4	8.0	12.0	Q1
LP2951ACMX-3.0/NOPB	SOIC	D	8	2500	330.0	12.4	6.5	5.4	2.0	8.0	12.0	Q1
LP2951ACMX-3.3/NOPB	SOIC	D	8	2500	330.0	12.4	6.5	5.4	2.0	8.0	12.0	Q1
LP2951ACMX/NOPB	SOIC	D	8	2500	330.0	12.4	6.5	5.4	2.0	8.0	12.0	Q1
LP2951ACSD/NOPB	WSO	NGT	8	1000	178.0	12.4	4.3	4.3	1.3	8.0	12.0	Q1
LP2951ACSDX-3.3/NOPB	WSO	NGT	8	4500	330.0	12.4	4.3	4.3	1.3	8.0	12.0	Q1
LP2951ACSDX/NOPB	WSO	NGT	8	4500	330.0	12.4	4.3	4.3	1.3	8.0	12.0	Q1

Device	Package Type	Package Drawing	Pins	SPQ	Reel Diameter (mm)	Reel Width W1 (mm)	A0 (mm)	B0 (mm)	K0 (mm)	P1 (mm)	W (mm)	Pin1 Quadrant
LP2951CMM-3.0/NOPB	VSSOP	DGK	8	1000	178.0	12.4	5.3	3.4	1.4	8.0	12.0	Q1
LP2951CMM-3.3/NOPB	VSSOP	DGK	8	1000	178.0	12.4	5.3	3.4	1.4	8.0	12.0	Q1
LP2951CMM/NOPB	VSSOP	DGK	8	1000	178.0	12.4	5.3	3.4	1.4	8.0	12.0	Q1
LP2951CMMX-3.0/NOPB	VSSOP	DGK	8	3500	330.0	12.4	5.3	3.4	1.4	8.0	12.0	Q1
LP2951CMMX-3.3/NOPB	VSSOP	DGK	8	3500	330.0	12.4	5.3	3.4	1.4	8.0	12.0	Q1
LP2951CMMX/NOPB	VSSOP	DGK	8	3500	330.0	12.4	5.3	3.4	1.4	8.0	12.0	Q1
LP2951CMX-3.0/NOPB	SOIC	D	8	2500	330.0	12.4	6.5	5.4	2.0	8.0	12.0	Q1
LP2951CMX-3.3/NOPB	SOIC	D	8	2500	330.0	12.4	6.5	5.4	2.0	8.0	12.0	Q1
LP2951CMX/NOPB	SOIC	D	8	2500	330.0	12.4	6.5	5.4	2.0	8.0	12.0	Q1
LP2951CSD-3.0/NOPB	WSON	NGT	8	1000	178.0	12.4	4.3	4.3	1.3	8.0	12.0	Q1
LP2951CSD-3.3/NOPB	WSON	NGT	8	1000	178.0	12.4	4.3	4.3	1.3	8.0	12.0	Q1
LP2951CSD/NOPB	WSON	NGT	8	1000	178.0	12.4	4.3	4.3	1.3	8.0	12.0	Q1
LP2951CSDX-3.3/NOPB	WSON	NGT	8	4500	330.0	12.4	4.3	4.3	1.3	8.0	12.0	Q1
LP2951CSDX/NOPB	WSON	NGT	8	4500	330.0	12.4	4.3	4.3	1.3	8.0	12.0	Q1

TAPE AND REEL BOX DIMENSIONS

*All dimensions are nominal

Device	Package Type	Package Drawing	Pins	SPQ	Length (mm)	Width (mm)	Height (mm)
LP2950CDTX-3.0/NOPB	TO-252	NDP	3	2500	356.0	356.0	35.0
LP2950CDTX-3.3/NOPB	TO-252	NDP	3	2500	356.0	356.0	35.0
LP2950CDTX-5.0/NOPB	TO-252	NDP	3	2500	356.0	356.0	35.0
LP2951ACMM-3.0/NOPB	VSSOP	DGK	8	1000	208.0	191.0	35.0
LP2951ACMM-3.3/NOPB	VSSOP	DGK	8	1000	208.0	191.0	35.0
LP2951ACMM/NOPB	VSSOP	DGK	8	1000	208.0	191.0	35.0
LP2951ACMMX-3.0/NOPB	VSSOP	DGK	8	3500	367.0	367.0	35.0
LP2951ACMMX-3.3/NOPB	VSSOP	DGK	8	3500	367.0	367.0	35.0
LP2951ACMMX/NOPB	VSSOP	DGK	8	3500	367.0	367.0	35.0
LP2951ACMX-3.0/NOPB	SOIC	D	8	2500	367.0	367.0	35.0
LP2951ACMX-3.3/NOPB	SOIC	D	8	2500	367.0	367.0	35.0
LP2951ACMX/NOPB	SOIC	D	8	2500	367.0	367.0	35.0
LP2951ACSD/NOPB	WSON	NGT	8	1000	208.0	191.0	35.0
LP2951ACSDX-3.3/NOPB	WSON	NGT	8	4500	367.0	367.0	35.0
LP2951ACSDX/NOPB	WSON	NGT	8	4500	367.0	367.0	35.0
LP2951CMM-3.0/NOPB	VSSOP	DGK	8	1000	208.0	191.0	35.0
LP2951CMM-3.3/NOPB	VSSOP	DGK	8	1000	208.0	191.0	35.0
LP2951CMM/NOPB	VSSOP	DGK	8	1000	208.0	191.0	35.0

Device	Package Type	Package Drawing	Pins	SPQ	Length (mm)	Width (mm)	Height (mm)
LP2951CMMX-3.0/NOPB	VSSOP	DGK	8	3500	367.0	367.0	35.0
LP2951CMMX-3.3/NOPB	VSSOP	DGK	8	3500	367.0	367.0	35.0
LP2951CMMX/NOPB	VSSOP	DGK	8	3500	367.0	367.0	35.0
LP2951CMX-3.0/NOPB	SOIC	D	8	2500	367.0	367.0	35.0
LP2951CMX-3.3/NOPB	SOIC	D	8	2500	367.0	367.0	35.0
LP2951CMX/NOPB	SOIC	D	8	2500	367.0	367.0	35.0
LP2951CSD-3.0/NOPB	WSON	NGT	8	1000	208.0	191.0	35.0
LP2951CSD-3.3/NOPB	WSON	NGT	8	1000	208.0	191.0	35.0
LP2951CSD/NOPB	WSON	NGT	8	1000	208.0	191.0	35.0
LP2951CSDX-3.3/NOPB	WSON	NGT	8	4500	367.0	367.0	35.0
LP2951CSDX/NOPB	WSON	NGT	8	4500	367.0	367.0	35.0

TUBE

*All dimensions are nominal

Device	Package Name	Package Type	Pins	SPQ	L (mm)	W (mm)	T (μm)	B (mm)
LP2950CDT-3.0/NOPB	NDP	TO-252	3	75	508	20	4165.6	3.1
LP2950CDT-3.3/NOPB	NDP	TO-252	3	75	508	20	4165.6	3.1
LP2950CDT-5.0/NOPB	NDP	TO-252	3	75	508	20	4165.6	3.1
LP2951ACM-3.0/NOPB	D	SOIC	8	95	495	8	4064	3.05
LP2951ACM-3.3/NOPB	D	SOIC	8	95	495	8	4064	3.05
LP2951ACM/NOPB	D	SOIC	8	95	495	8	4064	3.05
LP2951ACN/NOPB	P	PDIP	8	40	502	14	11938	4.32
LP2951CM-3.0/NOPB	D	SOIC	8	95	495	8	4064	3.05
LP2951CM-3.3/NOPB	D	SOIC	8	95	495	8	4064	3.05
LP2951CM/NOPB	D	SOIC	8	95	495	8	4064	3.05
LP2951CN/NOPB	P	PDIP	8	40	502	14	11938	4.32

DGK0008A



PACKAGE OUTLINE

VSSOP - 1.1 mm max height

SMALL OUTLINE PACKAGE



4214862/A 04/2023

NOTES:

PowerPAD is a trademark of Texas Instruments.

1. All linear dimensions are in millimeters. Any dimensions in parenthesis are for reference only. Dimensioning and tolerancing per ASME Y14.5M.
2. This drawing is subject to change without notice.
3. This dimension does not include mold flash, protrusions, or gate burrs. Mold flash, protrusions, or gate burrs shall not exceed 0.15 mm per side.
4. This dimension does not include interlead flash. Interlead flash shall not exceed 0.25 mm per side.
5. Reference JEDEC registration MO-187.

EXAMPLE BOARD LAYOUT

DGK0008A

™ VSSOP - 1.1 mm max height

SMALL OUTLINE PACKAGE



LAND PATTERN EXAMPLE
EXPOSED METAL SHOWN
SCALE: 15X



SOLDER MASK DETAILS

4214862/A 04/2023

NOTES: (continued)

6. Publication IPC-7351 may have alternate designs.
7. Solder mask tolerances between and around signal pads can vary based on board fabrication site.
8. Vias are optional depending on application, refer to device data sheet. If any vias are implemented, refer to their locations shown on this view. It is recommended that vias under paste be filled, plugged or tented.
9. Size of metal pad may vary due to creepage requirement.

EXAMPLE STENCIL DESIGN

DGK0008A

TM VSSOP - 1.1 mm max height

SMALL OUTLINE PACKAGE



SOLDER PASTE EXAMPLE
SCALE: 15X

4214862/A 04/2023

NOTES: (continued)

11. Laser cutting apertures with trapezoidal walls and rounded corners may offer better paste release. IPC-7525 may have alternate design recommendations.
12. Board assembly site may have different recommendations for stencil design.

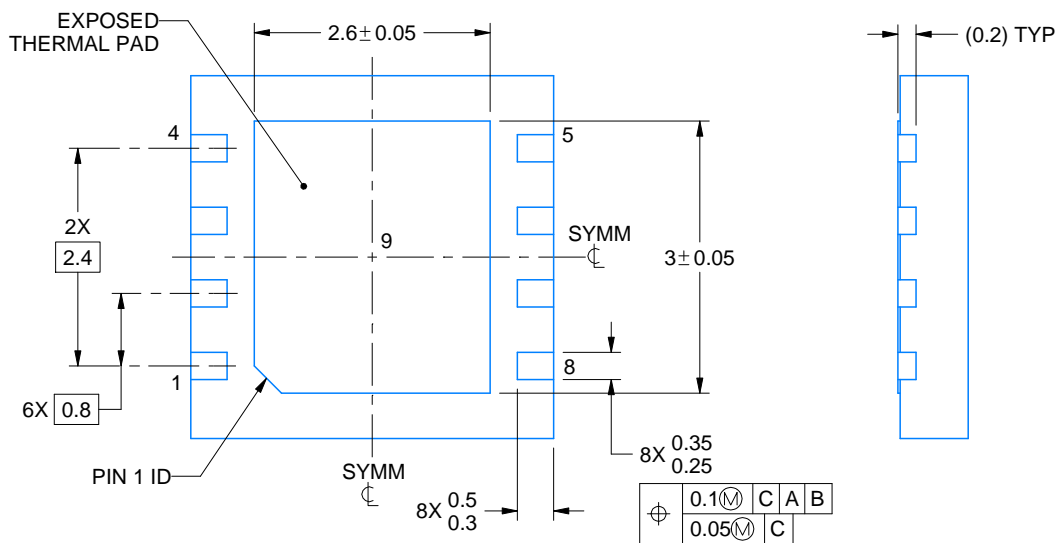
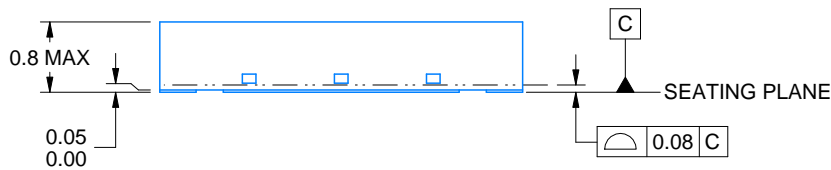
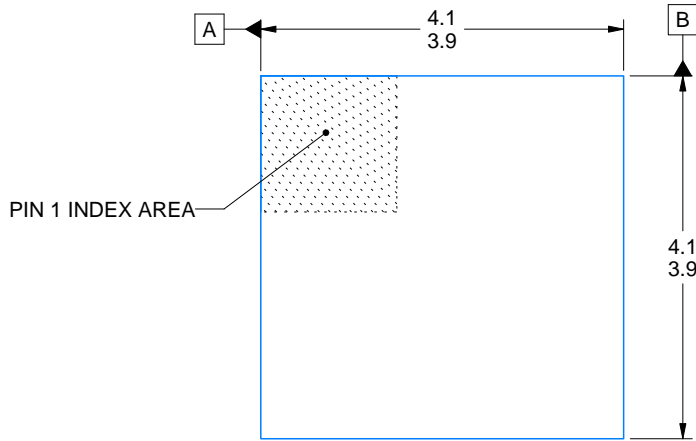
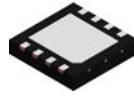

4214935/A 08/2020

NOTES:

1. All linear dimensions are in millimeters. Any dimensions in parenthesis are for reference only. Dimensioning and tolerancing per ASME Y14.5M.
2. This drawing is subject to change without notice.
3. The package thermal pad must be soldered to the printed circuit board for thermal and mechanical performance.

EXAMPLE BOARD LAYOUT

NGT0008A

WSON - 0.8 mm max height

PLASTIC SMALL OUTLINE - NO LEAD

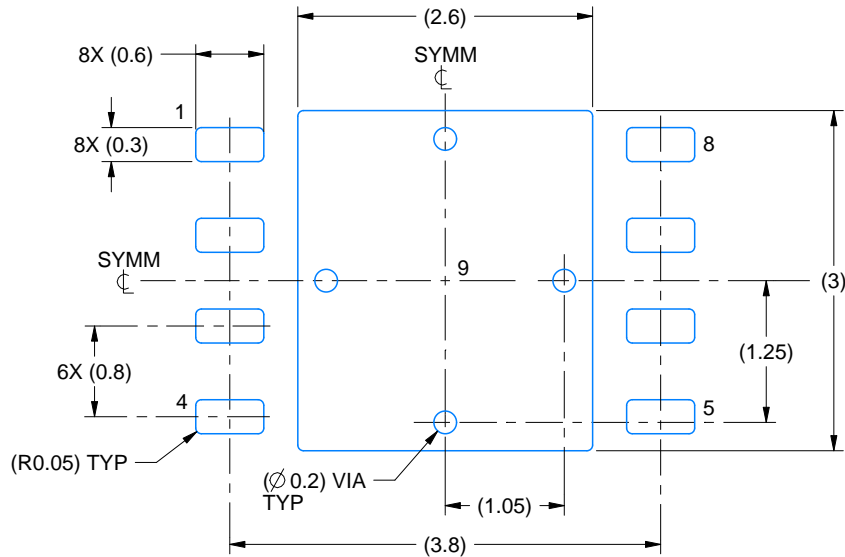

LAND PATTERN EXAMPLE
EXPOSED METAL SHOWN
SCALE:15X

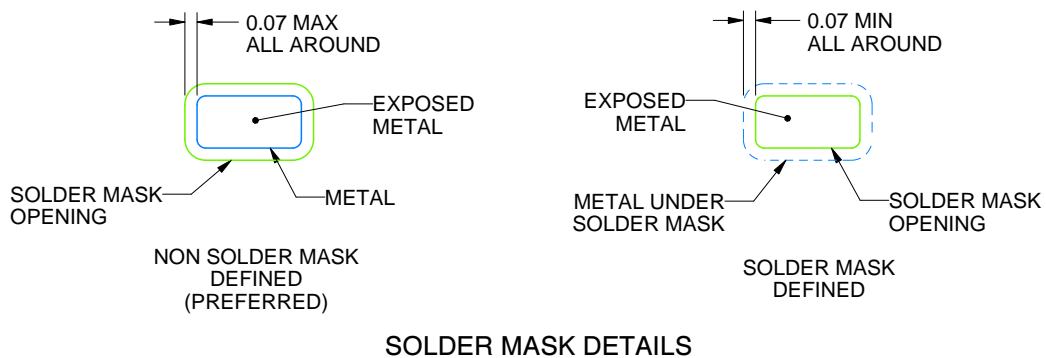

SOLDER MASK DETAILS

4214935/A 08/2020

NOTES: (continued)

4. This package is designed to be soldered to a thermal pad on the board. For more information, see Texas Instruments literature number SLUA271 (www.ti.com/lit/sluea271).
5. Vias are optional depending on application, refer to device data sheet. If any vias are implemented, refer to their locations shown on this view. It is recommended that vias under paste be filled, plugged or tented.

EXAMPLE STENCIL DESIGN

NGT0008A

WSON - 0.8 mm max height

PLASTIC SMALL OUTLINE - NO LEAD

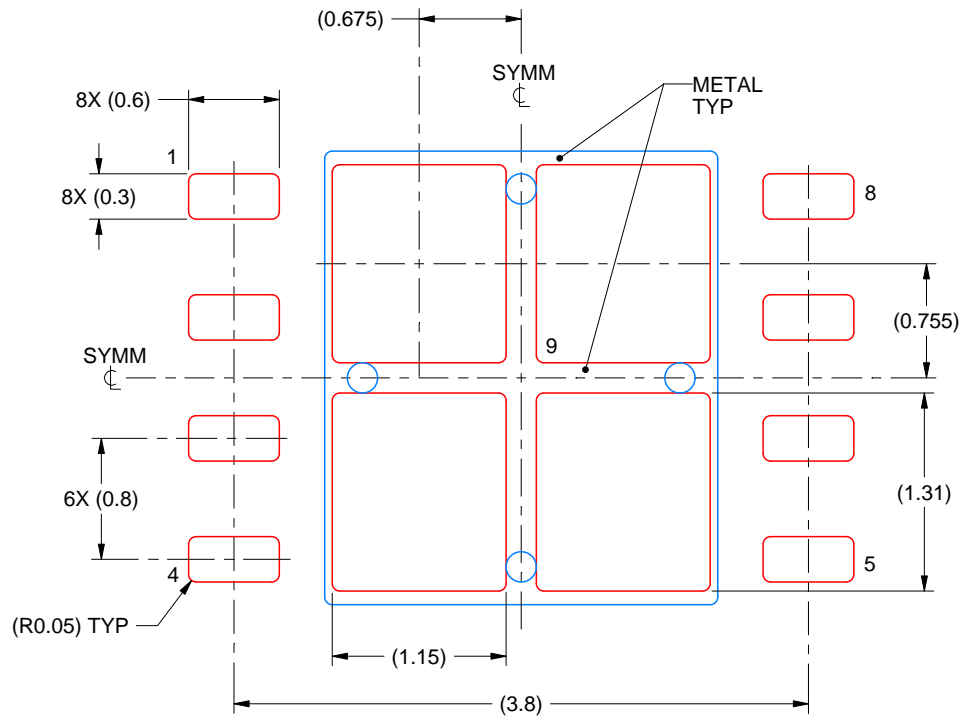

SOLDER PASTE EXAMPLE
BASED ON 0.125 mm THICK STENCIL

EXPOSED PAD 9:
77% PRINTED SOLDER COVERAGE BY AREA UNDER PACKAGE
SCALE:20X

4214935/A 08/2020

NOTES: (continued)

6. Laser cutting apertures with trapezoidal walls and rounded corners may offer better paste release. IPC-7525 may have alternate design recommendations.

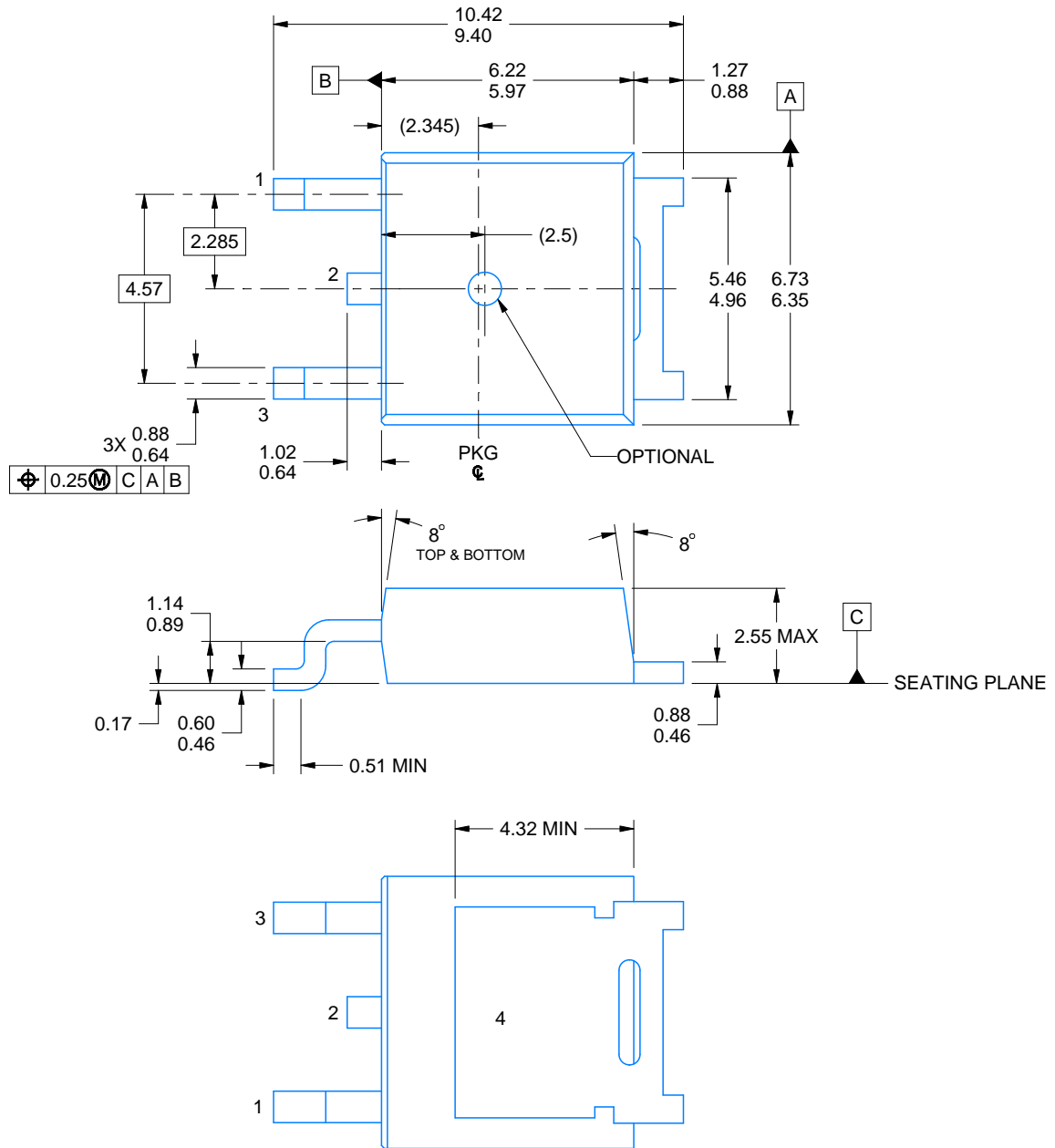

4219870/A 03/2018

NOTES:

1. All linear dimensions are in millimeters. Any dimensions in parenthesis are for reference only. Dimensioning and tolerancing per ASME Y14.5M.
2. This drawing is subject to change without notice.
3. Reference JEDEC registration TO-252.

EXAMPLE BOARD LAYOUT

NDP0003B

TO-252 - 2.55 mm max height

TRANSISTOR OUTLINE

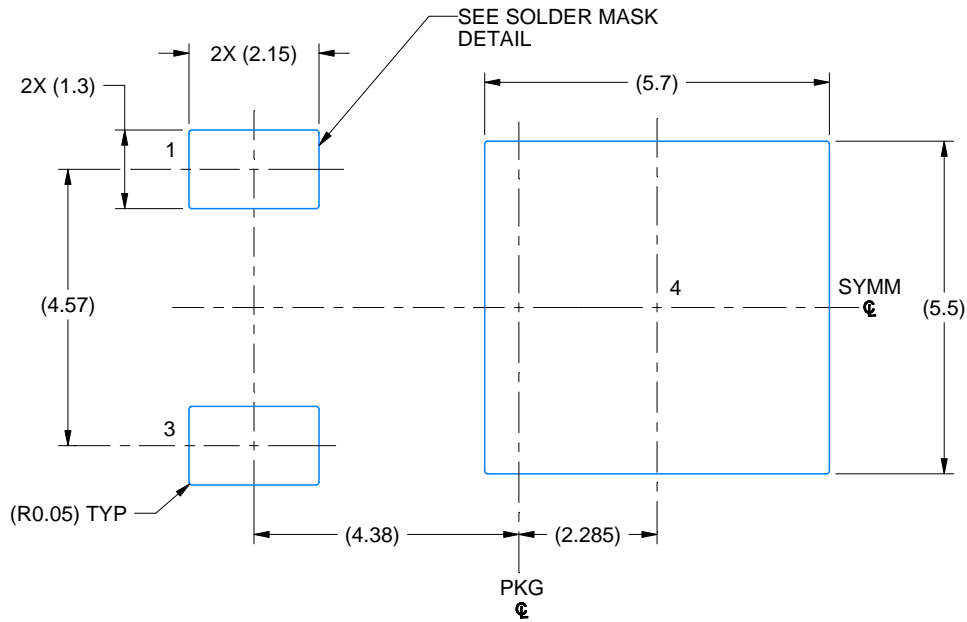

LAND PATTERN EXAMPLE
EXPOSED METAL SHOWN
SCALE: 8X

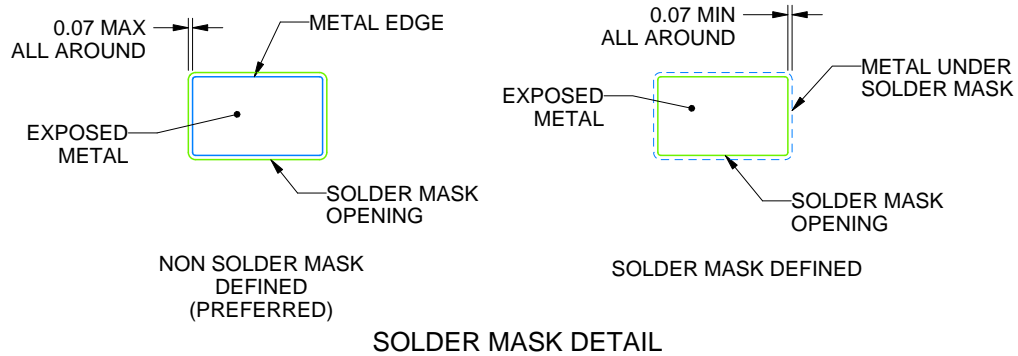

4219870/A 03/2018

NOTES: (continued)

4. This package is designed to be soldered to a thermal pad on the board. For more information, see Texas Instruments literature numbers SLMA002 (www.ti.com/lit/slm002) and SLMA004 (www.ti.com/lit/slma004).
5. Vias are optional depending on application, refer to device data sheet. It is recommended that vias under paste be filled, plugged or tented.

EXAMPLE STENCIL DESIGN

NDP0003B

TO-252 - 2.55 mm max height

TRANSISTOR OUTLINE

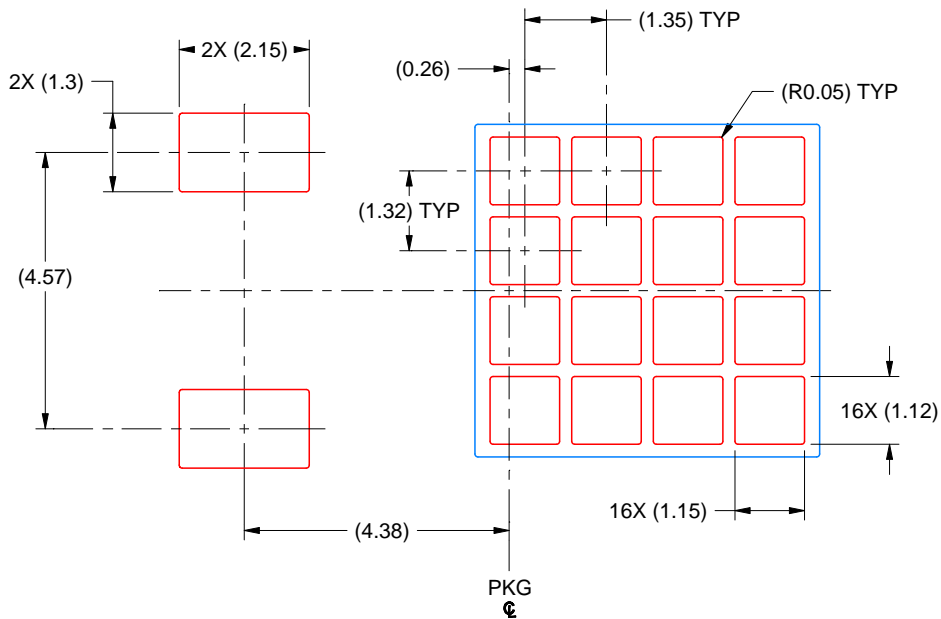

SOLDER PASTE EXAMPLE
BASED ON 0.125 MM THICK STENCIL
SCALE: 8X

4219870/A 03/2018

NOTES: (continued)

6. Laser cutting apertures with trapezoidal walls and rounded corners may offer better paste release. IPC-7525 may have alternate design recommendations.
7. Board assembly site may have different recommendations for stencil design.



D0008A

PACKAGE OUTLINE

SOIC - 1.75 mm max height

SMALL OUTLINE INTEGRATED CIRCUIT



4214825/C 02/2019

NOTES:

1. Linear dimensions are in inches [millimeters]. Dimensions in parenthesis are for reference only. Controlling dimensions are in inches. Dimensioning and tolerancing per ASME Y14.5M.
2. This drawing is subject to change without notice.
3. This dimension does not include mold flash, protrusions, or gate burrs. Mold flash, protrusions, or gate burrs shall not exceed $.006$ [0.15] per side.
4. This dimension does not include interlead flash.
5. Reference JEDEC registration MS-012, variation AA.

EXAMPLE BOARD LAYOUT

D0008A

SOIC - 1.75 mm max height

SMALL OUTLINE INTEGRATED CIRCUIT



LAND PATTERN EXAMPLE
EXPOSED METAL SHOWN
SCALE:8X



SOLDER MASK DETAILS

4214825/C 02/2019

NOTES: (continued)

6. Publication IPC-7351 may have alternate designs.

7. Solder mask tolerances between and around signal pads can vary based on board fabrication site.

EXAMPLE STENCIL DESIGN

D0008A

SOIC - 1.75 mm max height

SMALL OUTLINE INTEGRATED CIRCUIT



SOLDER PASTE EXAMPLE
BASED ON .005 INCH [0.125 MM] THICK STENCIL
SCALE:8X

4214825/C 02/2019

NOTES: (continued)

8. Laser cutting apertures with trapezoidal walls and rounded corners may offer better paste release. IPC-7525 may have alternate design recommendations.
9. Board assembly site may have different recommendations for stencil design.

P (R-PDIP-T8)

PLASTIC DUAL-IN-LINE PACKAGE



- NOTES:
- A. All linear dimensions are in inches (millimeters).
 - B. This drawing is subject to change without notice.
 - C. Falls within JEDEC MS-001 variation BA.

GENERIC PACKAGE VIEW

LP 3

TO-92 - 5.34 mm max height

TRANSISTOR OUTLINE



Images above are just a representation of the package family, actual package may vary.
Refer to the product data sheet for package details.

4040001-2/F

LP0003A



PACKAGE OUTLINE

TO-92 - 5.34 mm max height

TO-92



4215214/B 04/2017

NOTES:

1. All linear dimensions are in millimeters. Any dimensions in parenthesis are for reference only. Dimensioning and tolerancing per ASME Y14.5M.
2. This drawing is subject to change without notice.
3. Lead dimensions are not controlled within this area.
4. Reference JEDEC TO-226, variation AA.
5. Shipping method:
 - a. Straight lead option available in bulk pack only.
 - b. Formed lead option available in tape and reel or ammo pack.
 - c. Specific products can be offered in limited combinations of shipping medium and lead options.
 - d. Consult product folder for more information on available options.



LAND PATTERN EXAMPLE
STRAIGHT LEAD OPTION
NON-SOLDER MASK DEFINED
SCALE:15X



LAND PATTERN EXAMPLE
FORMED LEAD OPTION
NON-SOLDER MASK DEFINED
SCALE:15X

TAPE SPECIFICATIONS

LP0003A

TO-92 - 5.34 mm max height

TO-92

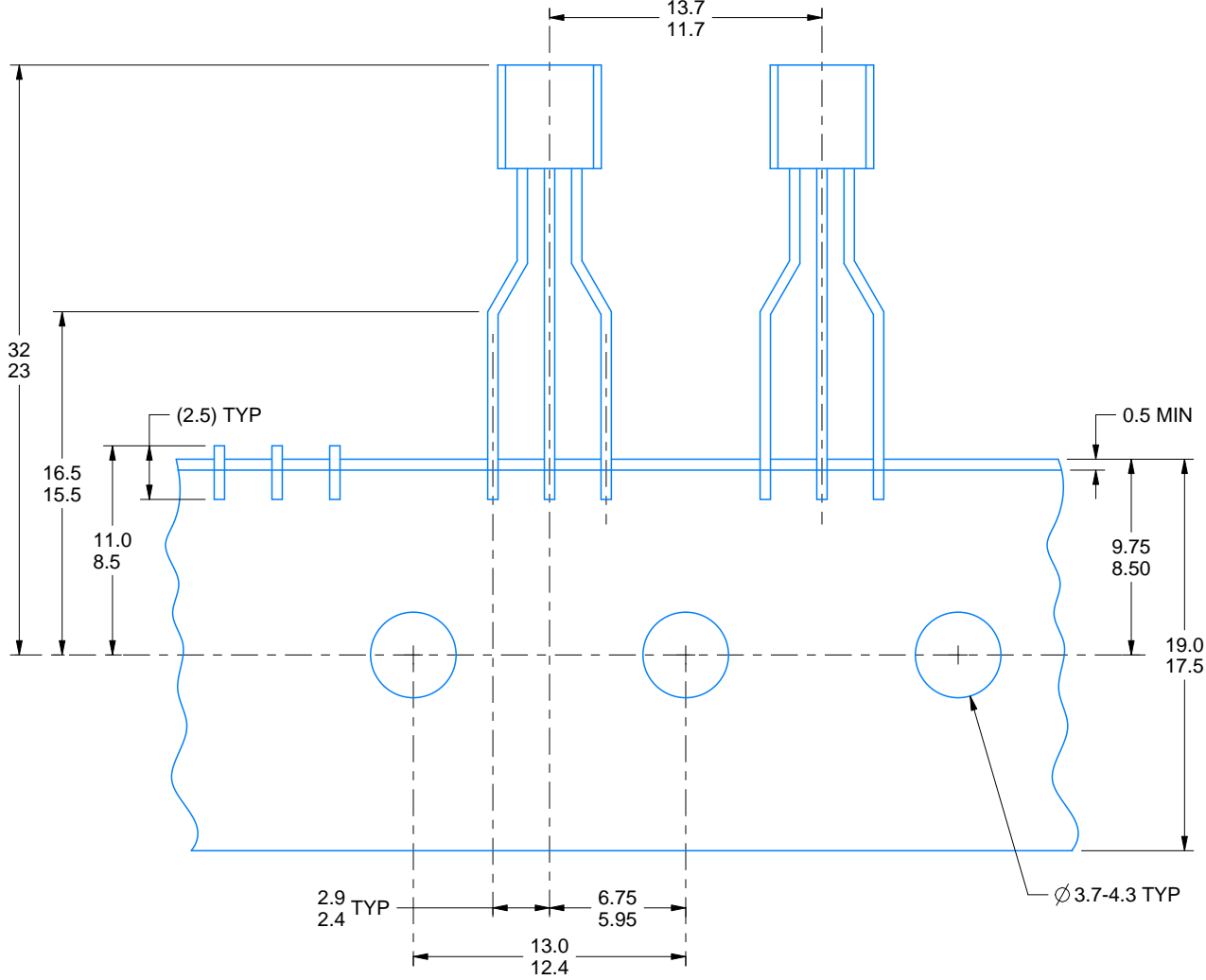

FOR FORMED LEAD OPTION PACKAGE

4215214/B 04/2017

IMPORTANT NOTICE AND DISCLAIMER

TI PROVIDES TECHNICAL AND RELIABILITY DATA (INCLUDING DATA SHEETS), DESIGN RESOURCES (INCLUDING REFERENCE DESIGNS), APPLICATION OR OTHER DESIGN ADVICE, WEB TOOLS, SAFETY INFORMATION, AND OTHER RESOURCES "AS IS" AND WITH ALL FAULTS, AND DISCLAIMS ALL WARRANTIES, EXPRESS AND IMPLIED, INCLUDING WITHOUT LIMITATION ANY IMPLIED WARRANTIES OF MERCHANTABILITY, FITNESS FOR A PARTICULAR PURPOSE OR NON-INFRINGEMENT OF THIRD PARTY INTELLECTUAL PROPERTY RIGHTS.

These resources are intended for skilled developers designing with TI products. You are solely responsible for (1) selecting the appropriate TI products for your application, (2) designing, validating and testing your application, and (3) ensuring your application meets applicable standards, and any other safety, security, regulatory or other requirements.

These resources are subject to change without notice. TI grants you permission to use these resources only for development of an application that uses the TI products described in the resource. Other reproduction and display of these resources is prohibited. No license is granted to any other TI intellectual property right or to any third party intellectual property right. TI disclaims responsibility for, and you will fully indemnify TI and its representatives against, any claims, damages, costs, losses, and liabilities arising out of your use of these resources.

TI's products are provided subject to [TI's Terms of Sale](#) or other applicable terms available either on [ti.com](https://www.ti.com) or provided in conjunction with such TI products. TI's provision of these resources does not expand or otherwise alter TI's applicable warranties or warranty disclaimers for TI products.

TI objects to and rejects any additional or different terms you may have proposed.

Mailing Address: Texas Instruments, Post Office Box 655303, Dallas, Texas 75265
Copyright © 2024, Texas Instruments Incorporated