

**DESCRIPTION**

This UPS5100e3 in the Powermite3<sup>®</sup> package is a high efficiency Schottky rectifier that is also RoHS compliant offering high current/power capabilities previously found only in much larger packages. They are ideal for SMD applications that operate at high frequencies. In addition to its size advantages, the Powermite3<sup>®</sup> package includes a full metallic bottom that eliminates the possibility of solder flux entrapment during assembly and a unique locking tab act as an efficient heat path to the heat-sink mounting. Its innovative design makes this device ideal for use with automatic insertion equipment.

**IMPORTANT:** For the most current data, consult MICROSEMI's website: <http://www.microsemi.com>

**ABSOLUTE MAXIMUM RATINGS AT 25° C  
(UNLESS OTHERWISE SPECIFIED)**

Rating	Symbol	Value	Unit
Peak Repetitive Reverse Voltage Working Peak Reverse Voltage DC Blocking Voltage	$V_{RRM}$ $V_{RWM}$ $V_R$	100	V
RMS Reverse Voltage	$V_{R(RMS)}$	70	V
Average Rectified Output Current	$I_o$	5	A
Non-Repetitive Peak Forward Surge Current 8.3ms Single half sine wave Superimposed on Rated Load@ $T_c = 90^\circ\text{C}$	$I_{FSM}$	100	A
Storage Temperature	$T_{STG}$	-55 to +150	°C
Junction Temperature	$T_J$	-55 to +125	°C

**THERMAL CHARACTERISTICS**
**Thermal Resistance**

Junction-to-Case (bottom)	$R_{\theta JC}$	2.5	°C/ Watt
Junction to Ambient (1)	$R_{\theta JA}$	65	°C/ Watt

(1) When mounted on FR-4 PC board using 2 oz copper with recommended minimum foot print

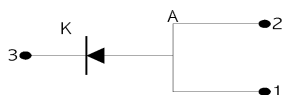
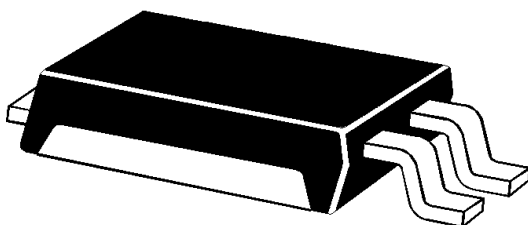
**Powermite 3™**

**KEY FEATURES**

- Very low thermal resistance package
- RoHS Compliant with e3 suffix part number
- Guard-ring-die construction for transient protection
- Efficient heat path with Integral locking bottom metal tab
- Low forward voltage
- Full metallic bottom eliminates flux entrapment
- Compatible with automatic insertion
- Low profile-maximum height of 1mm

**APPLICATIONS/BENEFITS**

- Switching and Regulating Power Supplies.
- Silicon Schottky (hot carrier) rectifier for minimal reverse voltage recovery
- Elimination of reverse-recovery oscillations to reduce need for EMI filtering
- Charge Pump Circuits
- Reduces reverse recovery loss with low  $I_{RM}$
- Small foot print  = 190 X 260 mils (1:1 Actual size)  
See mounting pad details on pg 3

**MECHANICAL & PACKAGING**

- CASE: Void-free transfer molded thermosetting epoxy compound meeting UL94V-0
- FINISH: Annealed matte-Tin plating over copper and readily solderable per MIL-STD-750 method 2026 (consult factory for Tin-Lead plating)
- POLARITY: See figure (left)
- MARKING: S5100•
- WEIGHT: 0.072 gram (approx.)
- Package dimension on last page
- Tape & Reel option: 16 mm tape per Standard EIA-481-B, 5000 on 13" reel

**ELECTRICAL PARAMETERS @ 25°C (unless otherwise specified)**

Parameter	Symbol	Conditions	Min	Typ.	Max	Units
Forward Voltage (Note 1)	$V_F$	$I_F = 5\text{ A}, T_L = 25\text{ }^\circ\text{C}$ $I_F = 5\text{ A}, T_L = 125\text{ }^\circ\text{C}$ $I_F = 10\text{ A}, T_L = 25\text{ }^\circ\text{C}$ $I_F = 10\text{ A}, T_L = 125\text{ }^\circ\text{C}$		0.75 0.58 0.84 0.67	0.81 0.64 0.90 0.73	V
Reverse Break Down Voltage (Note 1)	$V_{BR}$	$I_R = 0.2\text{ mA}$	100			V
Reverse Current (Note1)	$I_R$	$V_R = 100\text{V}, T_J = 25\text{ }^\circ\text{C}$ $V_R = 100\text{V}, T_J = 125\text{ }^\circ\text{C}$		15 10	200 20	$\mu\text{A}$ mA
Capacitance	$C_T$	$V_R = 4\text{ V}; f = 1\text{ MHz}$		150		pF

Note: 1 Short duration test pulse used to minimize self – heating effect.

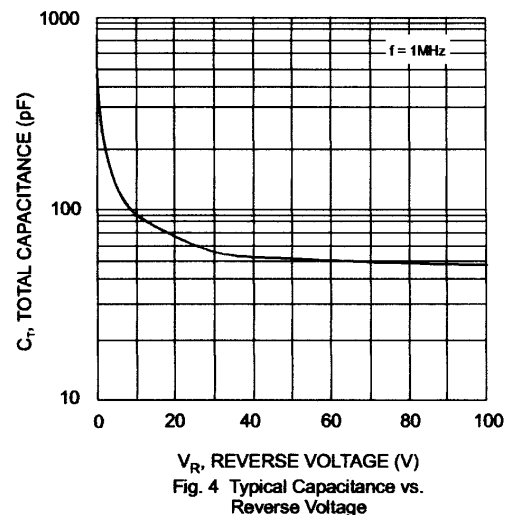
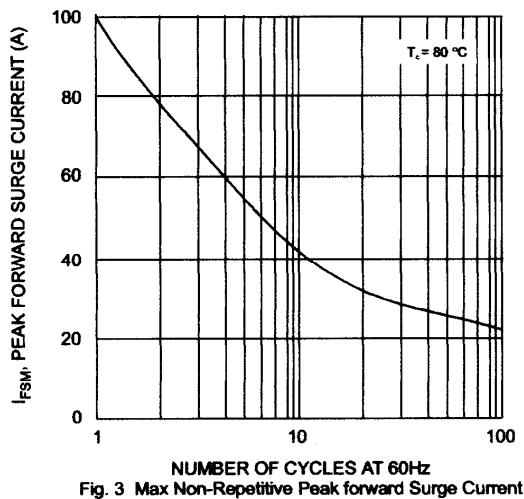
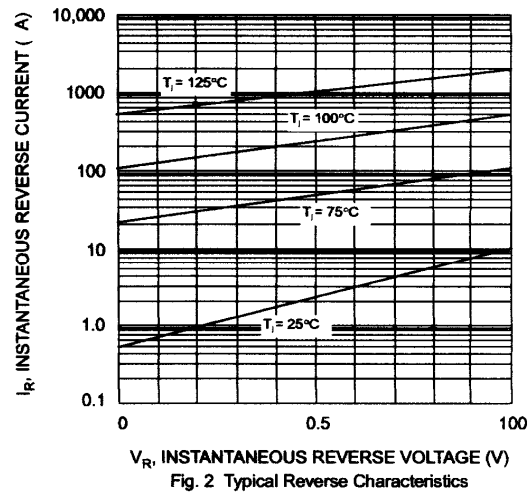
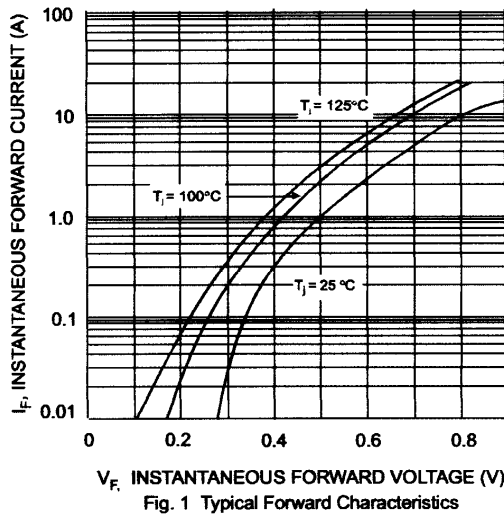

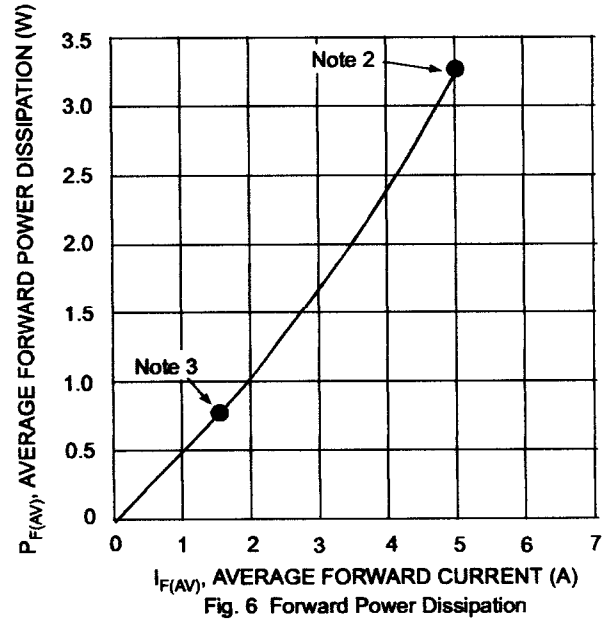
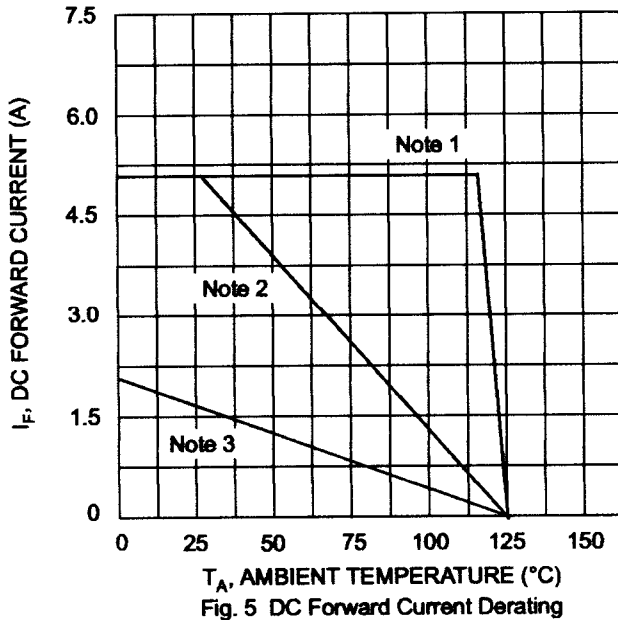

- Notes:
1.  $T_A = T_{\text{SOLDERING POINT}}$ ,  $R_{\theta JS} = 2.5^\circ\text{C/W}$ ,  $R_{\theta SA} = 0^\circ\text{C/W}$ .
  2. Device mounted on GETEK substrate, 2" x 2", 2 oz. copper, double-sided, cathode pad dimensions 0.75" x 1.0", anode pad dimensions 0.25" x 1.0".  $R_{\theta JA}$  in range of 20-35°C/W.
  3. Device mounted on FRA-4 substrate, 2" x 2", 2 oz. copper, single-sided, pad layout  $R_{\theta JA}$  in range of 65°C/W. See mounting pad below.

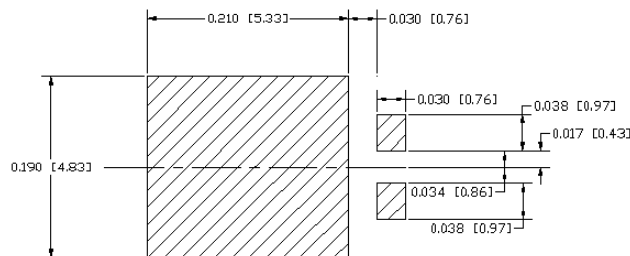
**MOUNTING PAD LAYOUT**

Mounting Pad Dimensions: inches [mm]

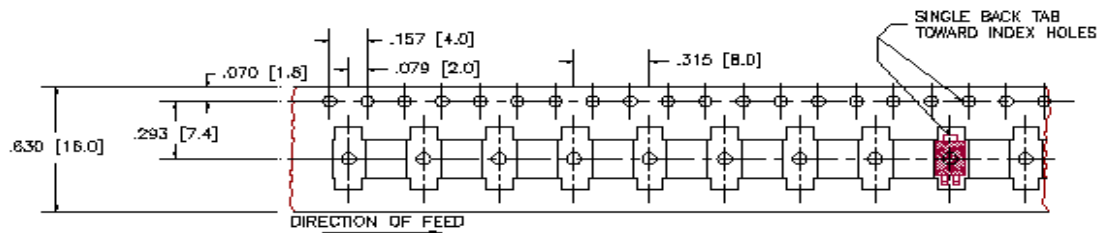
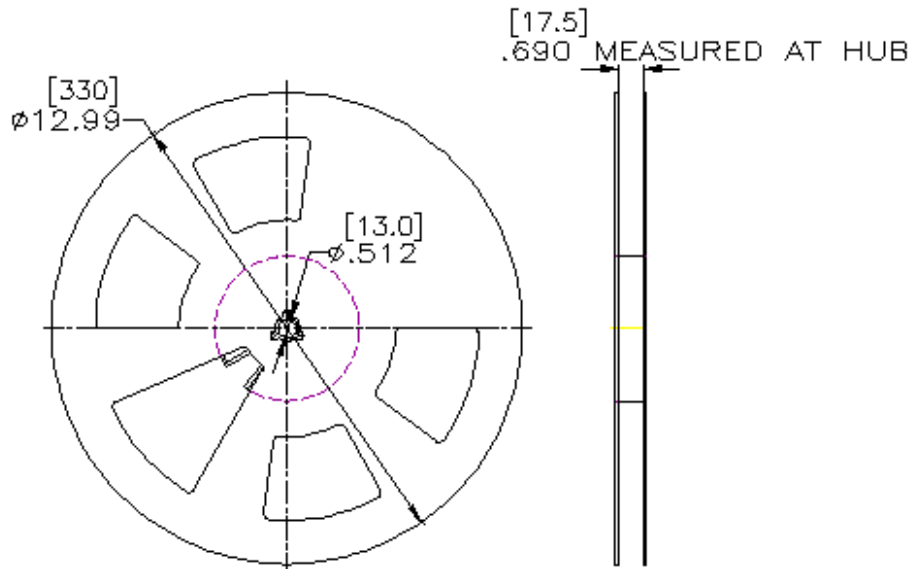
**TAPE & REEL**

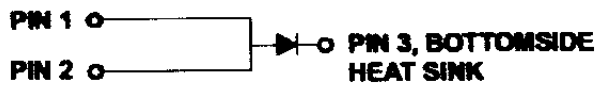
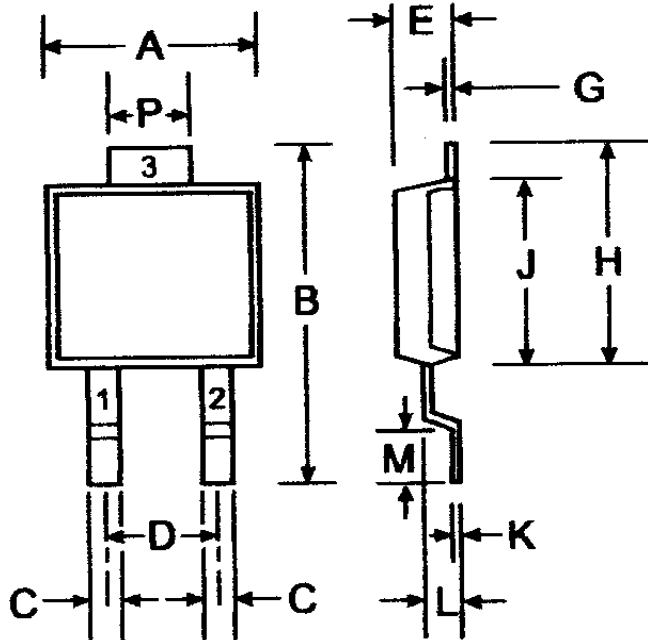
**13 INCH REEL**

**PACKAGE DIMENSIONS**

**Note:** Pins 1 & 2 must be electrically connected at the printed circuit board.

POWERMITE®3		
Dim	Min	Max
A	4.03	4.09
B	6.40	6.61
C	.889 NOM	
D	1.83 NOM	
E	1.10	1.14
G	.178 NOM	
H	5.01	5.17
J	4.37	4.43
K	.178 NOM	
L	.71	.77
M	.36	.46
P	1.73	1.83
<b>All Dimensions in mm</b>		

# Mouser Electronics

Authorized Distributor

Click to View Pricing, Inventory, Delivery & Lifecycle Information:

[Microsemi:](#)

[UPS5100E3/TR13](#) [UPS5100/TR13](#)