

PCB LAYOUT - COMPONENT VIEW

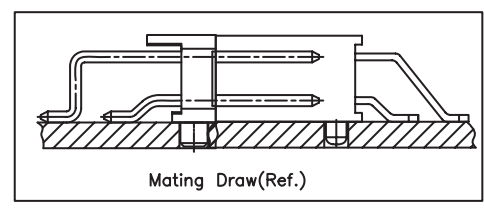

Mating Draw(Ref.)

TECHNICAL CHARACTERISTICS

MATERIAL
 INSULATOR: PA 6T
 FLAMABILITY RATING: UL94-V0
 COLOR: BLACK
 CONTACT MATERIAL: COPPER ALLOY
 CONTACT TYPE: STAMPED CONTACT
 PLATING: GOLD

ENVIRONMENTAL
 OPERATING TEMPERATURE: -40°C UP TO +105°C
 COMPLIANCE: LEAD FREE AND ROHS

ELECTRICAL
 CURRENT RATING: 3 A
 WORKING VOLTAGE: 250 VAC/DC
 INSULATION RESISTANCE: >1000MΩ
 WITHSTANDING VOLTAGE: 600 VAC/min
 CONTACT RESISTANCE: 20 mΩ max

STANDARD
 CERTIFIED: E323964

SOLDERING
 JEDEC LEAD FREE REFLOW SOLDERING PROCESS

PACKAGING
 TAPE & REEL

DIMENSIONS
 A = 2.54 x (NB. PINS/2-1)
 B = 2.54 x (NB. PINS/2)

AVAILABLE IN:
 6-8-10-12-14-16-20-22-24-26

RoHS Compliant			
G			
F			
E			
D			
C			
B	29-JUL-16	CERTIFICATION UL	AK
A	06-NOV-14	PDF	AS
REV	DATE	FILE	BY

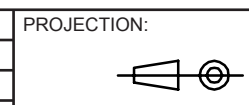

GENERAL TOLERANCE
 .X = +/- 0.2
 .XX = +/- 0.15



APPROVAL: GMo

UNIT: MM
 SCALE:
 SHEET: 1/3
 DRAW: AS

DESCRIPTION: WR-PHD - 2.54MM PIN HEADER - SMT TYPE
 DOUBLE ROW RIGHT ANGLE
 WERI PART NO: 610 1xx 249 121

SIZE
A4

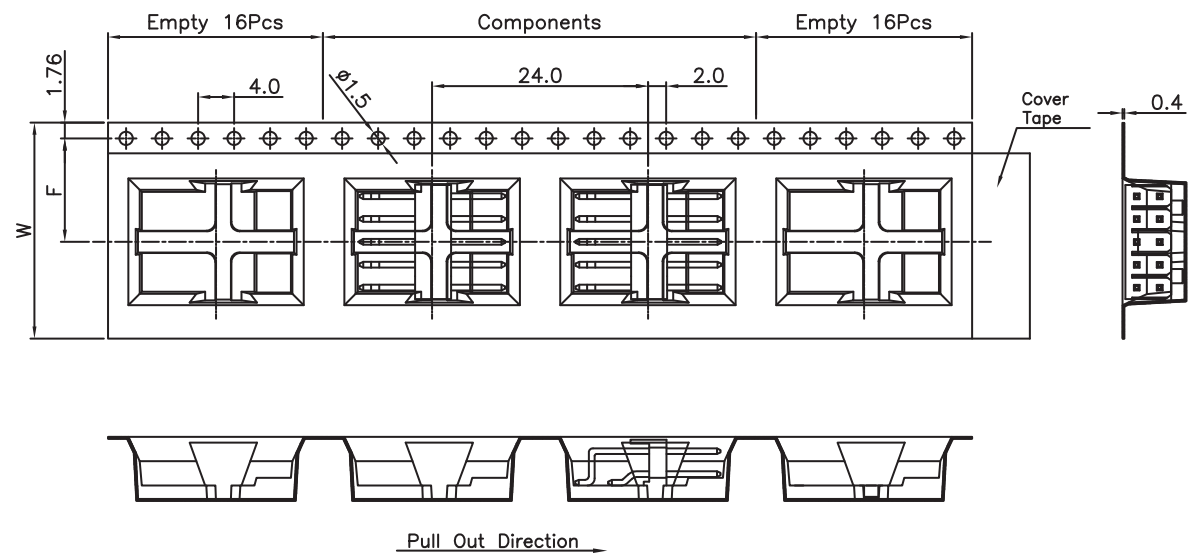
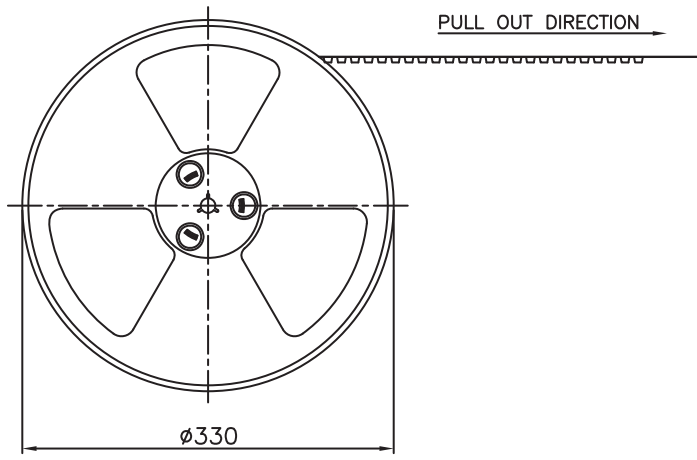
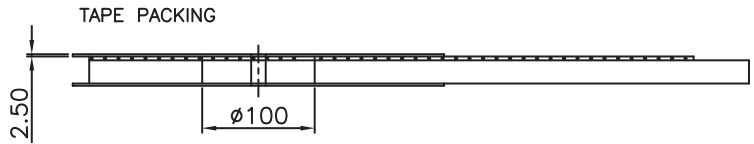

Pin No	W	F	PCS/R	R/CTN	Q'TY
06	16	7.5	350	12	4200
08-12	24	11.5	350	9	3150
14-16	32	14.2	350	7	2450
20-26	44	20.2	350	5	1750

RoHS Compliant			
G			
F			
E			
D			
C			
B			
A	07-NOV-14	PDF	AS
REV	DATE	FILE	BY

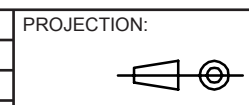

GENERAL TOLERANCE

.X = +/- 0.2

.XX = +/- 0.15



APPROVAL: GMo

UNIT: MM

SCALE:

SHEET: 2/3

DRAW: AS

DESCRIPTION: WR-PHD - 2.54MM PIN HEADER - SMT TYPE

DOUBLE ROW RIGHT ANGLE

WERI PART NO: 610 1xx 249 121

SIZE

A4

1

2

3

4

5

Cautions and Warnings:

This electronic component is designed and developed with the intention for use in general electronics equipments.

Before incorporating the components into any equipments in the field such as aerospace, aviation, nuclear control, submarine, transportation, (automotive control, train control, ship control), transportation signal, disaster prevention, medical, public information network etc. where higher safety and reliability are especially required or if there is possibility of direct damage or injury to human body, Würth Elektronik must be asked for a written approval.



In addition, even electronic component in general electronic equipments, when used in electrical circuits that require high safety, reliability functions or performance, the sufficient reliability evaluation-check for the safety must be performed before by the user before usage.

A

B

C

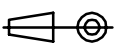
RoHS Compliant

G				PROJECTION: 	GENERAL TOLERANCE .X = +/- 0.2 .XX = +/- 0.15		
F							
E							
D							
C				APPROVAL: JC	UNIT: MM	DESCRIPTION: DISCLAIMER	SIZE A4
B					SCALE:		
A	10-SEP-14	PDF	QL		SHEET: 3/3	WERI PART NO: DISCLAIMER	
REV	DATE	FILE	BY		DRAW: QL		

D

Mouser Electronics

Authorized Distributor

Click to View Pricing, Inventory, Delivery & Lifecycle Information:

Würth Electronics:

[610120249121](#) [610110249121](#) [610122249121](#) [610124249121](#) [610108249121](#) [610106249121](#) [610126249121](#)
[610112249121](#) [610114249121](#) [610116249121](#)