

●Features

- Viewing angle 2θ 1/2 : 40°

●Outline

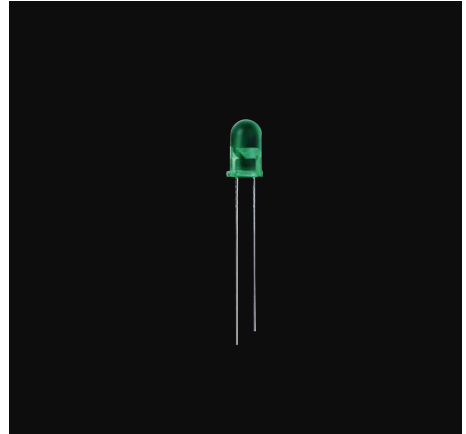

Color Type E B WB

●Dimensions

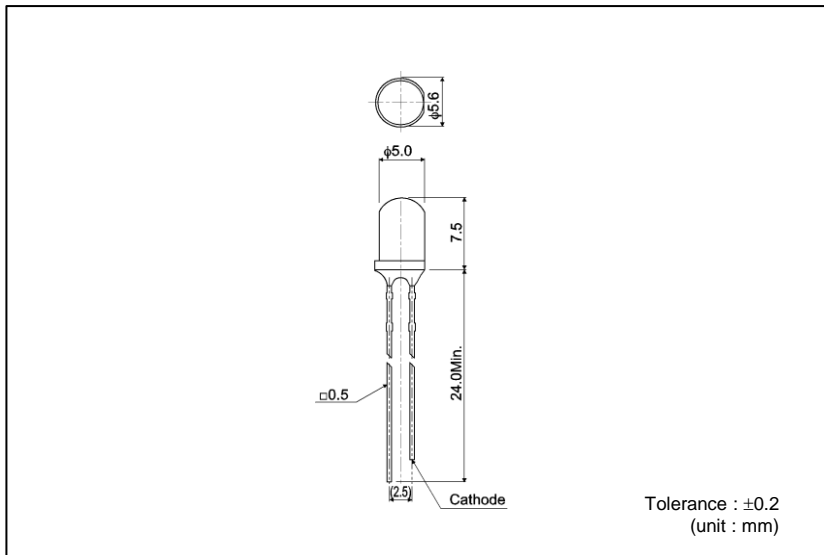

●Recommended Solder Pattern

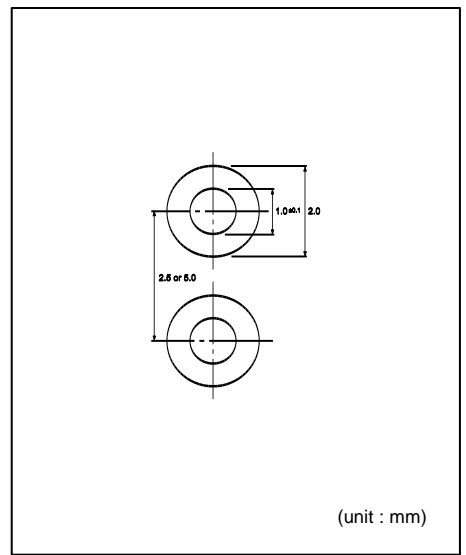

●Specifications

Viewing angle 2θ 1/2 / 40° : Standard

Part No.	Chip Structure	Emitting Color	Absolute Maximum Ratings (Ta=25°C)					Electrical and Optical Characteristics (Ta=25°C)									
			Power Dissipation	Forward Current	Peak Forward Current	Reverse Voltage	Operating Temp.	Storage Temp.	Forward Voltage V _F		Reverse Current I _R		Dominant Wavelength λ_D		Luminous Intensity I _v		
			P _D (mW)	I _F (mA)	I _{FP} (mA)	V _R (V)	Topr(°C)	Tstg(°C)	Typ. (V)	I _F (mA)	Max. (μA)	V _R (V)	Typ. (nm)	I _F (mA)	Min. (mcd)	Typ. (mcd)	I _F (mA)
SLA560ECT	InGaN	Bluish Green	120	30	100*	5	-20 to +80	-30 to +100	3.3	20	100	5	527	20	610	2000	20
SLA560EC4T									3.2				525			1500	
SLA560BCT		Blue	120	30	100*	5	-20 to +80	-30 to +100	3.3	20	100	5	470	20	200	600	20
SLA560BC4T									3.2				470			470	

*:Duty1/10, 1kHz

●Electrical Characteristics Curves

Fig.1 Forward Current - Forward Voltages

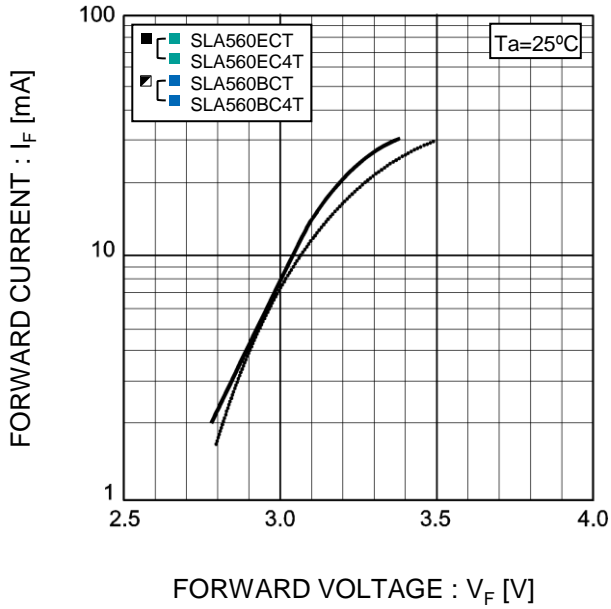

Fig.2 Luminous Intensity - Atmosphere Temperature

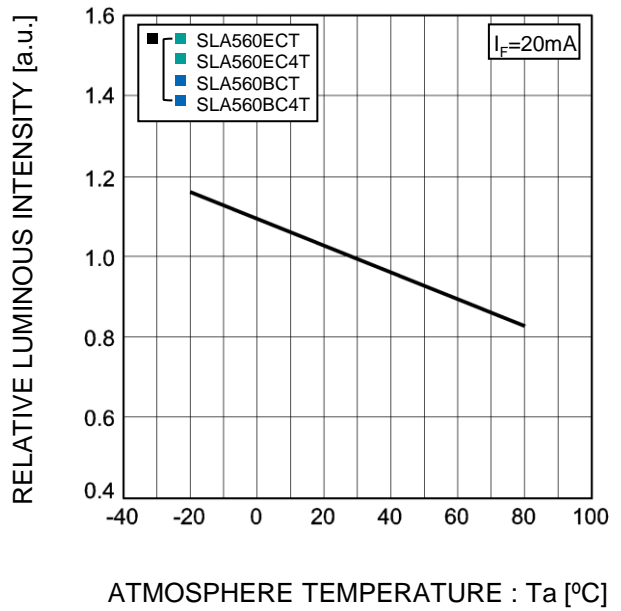

Fig.3 Luminous Intensity - Forward Current

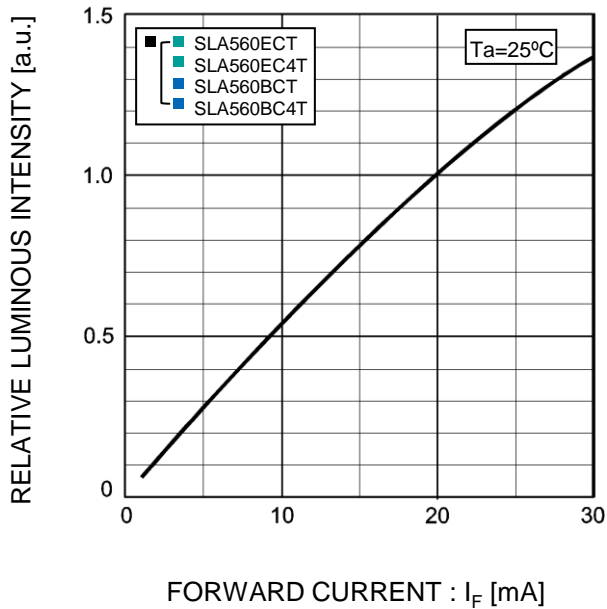
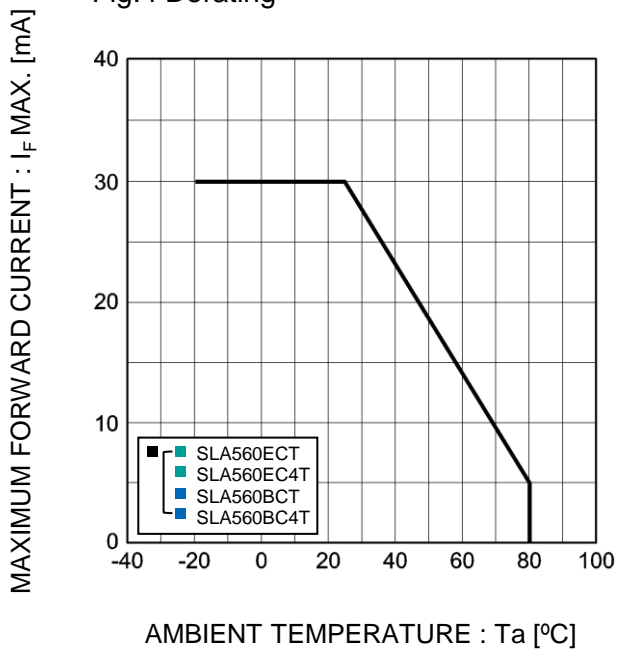
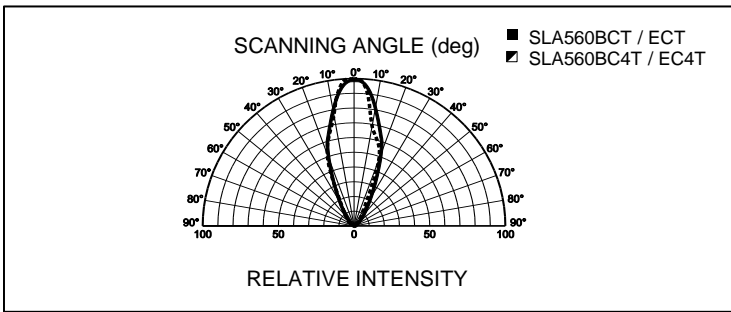

Fig.4 Derating



●Viewing Angle



●Rank Reference of Brightness

Green(E)

(Ta=25°C, If=20mA)

Rank	XL	XM	XN	XP	XQ	XR	XS	XT	XU
Iv (mcd)	470 to 680	680 to 1000	1000 to 1500	1500 to 2200	2200 to 3300	3300 to 4700	4700 to 6800	6800 to 10000	10000 to 15000
*SLA560EC4T									
*SLA560ECT									

Blue (B)

(Ta=25°C, If=20mA)

Rank	XH	XJ	XK	XL	XM	XN	XP	XQ	XR	XS	XT	XU
Iv (mcd)	150 to 220	220 to 330	330 to 470	470 to 680	680 to 1000	1000 to 1500	1500 to 2200	2200 to 3300	3300 to 4700	4700 to 6800	6800 to 10000	10000 to 15000
*SLA560BC4T												
*SLA560BCT												

*Brightness on specification sheet include tolerance of within ±10%.

●Part No. Construction

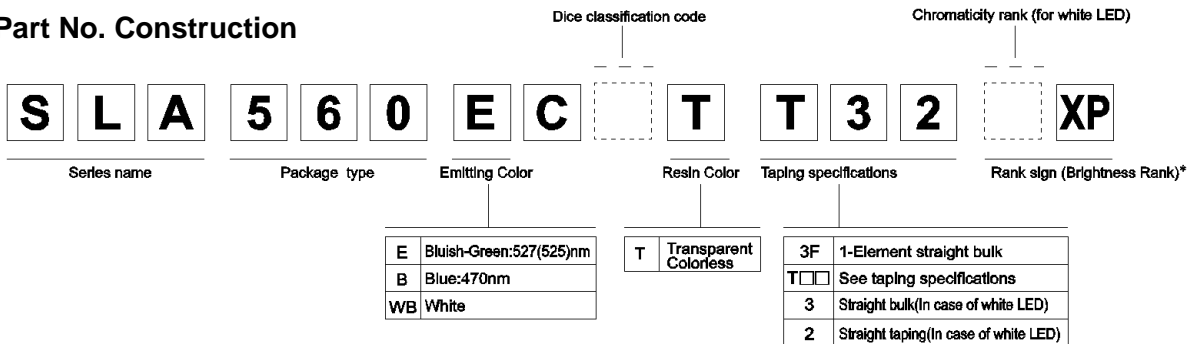

- Concerning the Brightness rank
 - Please refer to the rank chart above for luminous intensity classification.
 - Part name is individual for each rank.
 - When shipped as sample, the part name will be a representative part name.
- General products are free of ranks. Please contact sales if rank appointment is needed.

●Attention Points In Handling

Visual light emitting diode does not contain reinforcement materials such as glass fillers. Therefore if sudden thermal and mechanical shock are given, destruction or inferiority of luminous intensity may occur. Please take care of the handling.

■FIXATION METHOD

1. ATTENTION POINTS

- (1) Please do not give excessive heat over storage temperature to resin.
In case that the product has to be heated in oven for the glue fixing of surface mount parts, this LED should be mounted after the glue fixing.
- (2) Please avoid stress to resin at high temperature.

2. TERMINATION PROCESSING

- (1) In case of termination processing, please fix the termination
- (2) Processing position, and process the reverse side of LED body.
If stress is given during processing, It may cause non-lighting failure.
- (3) Please process before soldering.

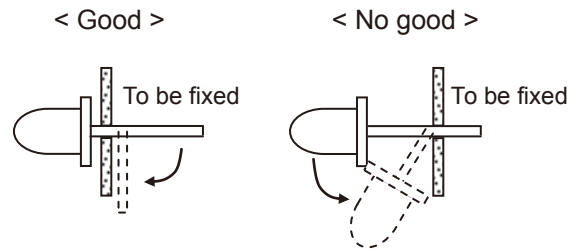

3. ASSEMBLY ON PC BOARD

- (1) In case of soldering on PCB, If the operation is done with stress, it may cause non-lighting failure during soldering or using.
Please design the through-holes of PCB suitable for lead pins space or lead pins space after formin to avoid the physical stress on resin.

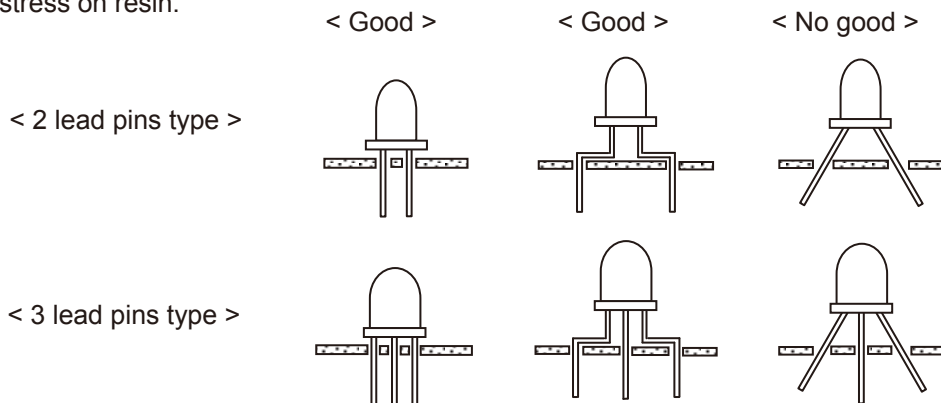

- (2) Using spacer between LED's body and PCB is recommended.
In case of direct mount on PCB(SLR/SLI-343 series), please take care about clinch of led pins to avoid the remained stress and solder heat stress.
Enough evaluation is requested before deciding assembly and soldering conditions.
Please consult with us if any problems in the evaluation stage.

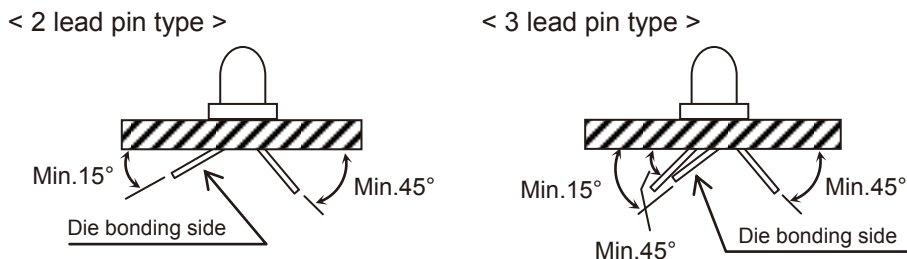

4. SOLDERING (Sn-3Ag-0.5Cu)

- (1) Please make soldering rapidly under the following temperature and time conditions.
- (2) Please avoid stress to LED lamp during soldering.
- (3) In case of double peak flow soldering, the temperature gap during 1st and 2nd soldering to be less than 100 degree C.

<Recommendable soldering conditions>

ARTIICLE		SOLDERING TEMP	OPERATION TIME	Remarks
Soldering Dip	Pre-heat	Max. 100°C	60sec Max.	-
	Soldering Bath	Max. 265°C	5sec Max.	In case of double peak flow soldering, the operation time is counted from the beginning of 1st peak to the end of 2nd peak.
Soldering Iron		Max. 400°C	3sec Max.	The iron should not touch the LED's body.

5. CLEANING

In case of cleaning, some solvents may cause damage of resin or cause non-lighting failure, so please check the solvent before actual use.

The recommendable cleaning solvent is alcoholic one such as isopropyl alcohol.

<RECOMMENDABLE CLEANING CONDITIONS>

METHOD	CONDITIONS	
Cleaning by solvent	Temperature of solvent	: Max. 45°C
	Immersion time	: Max. 3min
Cleaning by solvent	Ultrasonic out	: Ultrasonic out
	Cleaning time	: Max. 3min

6. RECOMMENDABLE ROUND PATTERN

Round pattern depends on the material PCB, density and circuit arrangement.

Our recommendation is as follow :

< 2lead pin type >

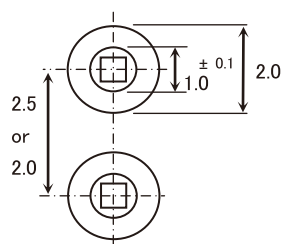

< 3lead pin type/2.5mm pitch >

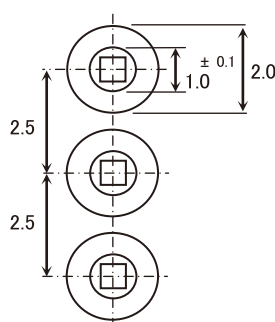

< 3 lead pin type/2.0mm pitch >

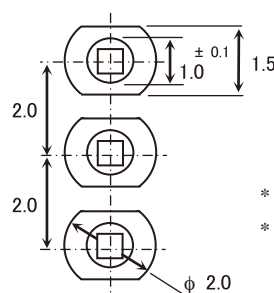

* Unit : mm

* Lead types : □0.4mm

□0.5mm

■ATTENTION ON STORAGING

Storage in dry box is most desirable, but if it is not possible, we recommend following conditions.

<RECOMMENDABLE STORAGE CONDITIONS>

ARTICLE	Temperature	Humidity	Expiration Date
CONDITIONS	5 to 30°C	Max.60%RH	Within 1 year

Poor storage conditions may cause some failure as bellow.

- (1) Lead pins may corrode if it is stored in the environment of high temperature and humidity and lead to defective soldering.
- (2) In case of soldering after LED's body absorb moisture highly, destruction or inferiority of luminous intensity may occur.

■APPLICATION METHOD**1. Precaution for Drive System and Off Mode**

- Design the circuit without the electric load exceeding the ABSOLUTE MAXIMUM RATING that applies on the products.
- If drive by constant voltage, it may cause current deviation of the LED and result in deviation of luminous intensity, so we recommend to drive by constant current. (Deviation of VF Value will cause deviation of current in LED.)
- Furthermore, for off mode, please do not apply voltage neither forward nor reverse. Especially, for the products with the Ag-paste used in the die bonding, there's high possibility to cause electro migration and result in function failure.

2. Operation Life Span

There's possibility for intensity of light drop according to working conditions and environments (applied current, surrounding temperature and humidity, corrosive gases), please call our Sales staffs for inquiries about the concerned application below.

- (1) Longtime intensity of light life
- (2) On mode all the time

3. Usage

The Product is LED. We are not responsible for the usage as the diode such as Protection Chip, Rectifier, Switching and so on.

■OTHERS**1. Surrounding Gas**

Notice that if it is stored under the condition of acid gas (chlorine gas, sulfured gas) or alkali gas (ammonia), it may result in low soldering ability (caused by the change in quality of the plating surface) or optical characteristics changes (light intensity, chrominance) and change in quality of die bonding (Ag-paste) aterials.

All of the above will cause function failure of the products.

Therefore, please pay attention to the storage environment for mounted product (concern the generated gas of the surrounding parts of the products and the atmospheric environment).

2. Electrostatic Damage

The product is part of semiconductor and electrostatic sensitive, there's high possibility to be damaged by the electrostatic discharge.

Please take appropriate measures to avoid the static electricity from human body and earthing setting of production equipment. The resistance values of electrostatic discharge (actual values) are different varies with products, therefore, please call our Sales staffs for inquiries.

3. Electromagnetic Wave

Please concern the influence on LED in case of application with strong electromagnetic wave such as IH (Induction heating).

Notes

- 1) The information contained herein is subject to change without notice.
- 2) Before you use our Products, please contact our sales representative and verify the latest specifications :
- 3) Although ROHM is continuously working to improve product reliability and quality, semiconductors can break down and malfunction due to various factors.
Therefore, in order to prevent personal injury or fire arising from failure, please take safety measures such as complying with the derating characteristics, implementing redundant and fire prevention designs, and utilizing backups and fail-safe procedures. ROHM shall have no responsibility for any damages arising out of the use of our Products beyond the rating specified by ROHM.
- 4) Examples of application circuits, circuit constants and any other information contained herein are provided only to illustrate the standard usage and operations of the Products. The peripheral conditions must be taken into account when designing circuits for mass production.
- 5) The technical information specified herein is intended only to show the typical functions of and examples of application circuits for the Products. ROHM does not grant you, explicitly or implicitly, any license to use or exercise intellectual property or other rights held by ROHM or any other parties. ROHM shall have no responsibility whatsoever for any dispute arising out of the use of such technical information.
- 6) The Products are intended for use in general electronic equipment (i.e. AV/OA devices, communication, consumer systems, gaming/entertainment sets) as well as the applications indicated in this document.
- 7) The Products specified in this document are not designed to be radiation tolerant.
- 8) For use of our Products in applications requiring a high degree of reliability (as exemplified below), please contact and consult with a ROHM representative : transportation equipment (i.e. cars, ships, trains), primary communication equipment, traffic lights, fire/crime prevention, safety equipment, medical systems, servers, solar cells, and power transmission systems.
- 9) Do not use our Products in applications requiring extremely high reliability, such as aerospace equipment, nuclear power control systems, and submarine repeaters.
- 10) ROHM shall have no responsibility for any damages or injury arising from non-compliance with the recommended usage conditions and specifications contained herein.
- 11) ROHM has used reasonable care to ensure the accuracy of the information contained in this document. However, ROHM does not warrants that such information is error-free, and ROHM shall have no responsibility for any damages arising from any inaccuracy or misprint of such information.
- 12) Please use the Products in accordance with any applicable environmental laws and regulations, such as the RoHS Directive. For more details, including RoHS compatibility, please contact a ROHM sales office. ROHM shall have no responsibility for any damages or losses resulting non-compliance with any applicable laws or regulations.
- 13) When providing our Products and technologies contained in this document to other countries, you must abide by the procedures and provisions stipulated in all applicable export laws and regulations, including without limitation the US Export Administration Regulations and the Foreign Exchange and Foreign Trade Act.
- 14) This document, in part or in whole, may not be reprinted or reproduced without prior consent of ROHM.



Thank you for your accessing to ROHM product informations.
More detail product informations and catalogs are available, please contact us.

ROHM Customer Support System

<http://www.rohm.com/contact/>

Mouser Electronics

Authorized Distributor

Click to View Pricing, Inventory, Delivery & Lifecycle Information:

[ROHM Semiconductor:](#)

[SLA560BC4T3F](#) [SLA560BCT3F](#) [SLA560EC4T3F](#) [SLA560ECT3F](#) [SLA560WBC7T2](#) [SLA560BC7T3F](#)