

## Metallized Polypropylene Film Capacitor Radial Snubber Type

**FEATURES**

- Reduce EMI by clamping voltage and current ringing
- High pulse strength (dV/dt up to 2500 V/μs)
- Low inductance construction (low ESL)
- Low ESR
- Material categorization:  
for definitions of compliance please see [www.vishay.com/doc?99912](http://www.vishay.com/doc?99912)



**RoHS**  
COMPLIANT  
HALOGEN  
**FREE**  
**GREEN**  
(5-2008)

**APPLICATIONS**

- Photovoltaic and wind inverters
- Motor drives
- Frequency converters
- Direct mount on IGBT modules

| QUICK REFERENCE DATA                                     |  |
|--|--|
| Rated capacitance range                                  | 0.047 μF to 10 μF  |
| Capacitance tolerance                                    | ± 5 %/± 10 %   |
| Rated (DC) voltage, U <sub>NDC</sub>                     | 700 V, 850 V, 1000 V, 1250 V, 1600 V, 2000 V, 2500 V   |
| Climatic testing class                                   | 55/105/56  |
| Rated temperature  | 85 °C  |
| Maximum permissible case temperature                     | 105 °C   |
| Rated (AC) voltage                                       | 420 V, 400 V to 450 V, 425 V to 500 V, 450 V to 550 V, 450 V to 600 V, 700 V, 800 V  |
| Reference standards                                      | IEC 60384-17   |
| Dielectric   | Polypropylene film   |
| Electrodes   | Metallized film  |
| Construction   | Series construction  |
| Encapsulation  | Flame retardant plastic case and epoxy resin sealed  |
| Terminals  | Tinned coated copper   |
| Self inductance (L <sub>S</sub> )                        | < 0.7 nH per mm of lead spacing  |
| Withstanding DC voltage between terminals <sup>(1)</sup> | 1.6 U <sub>RDC</sub> for 60 s (maximum rise time 1000 V/s; cut off current 10 mA)  |
| Test voltage between terminals and case                  | 1.4 U <sub>RAC</sub> + 2000 V <sub>DC</sub> for 60 s   |
| Insulation resistance                                    | RC between leads, at 500 V after 1 min:<br>> 100 GΩ for C ≤ 0.33 μF<br>> 30 000 s for C > 0.33 μF  |
| Performance grade  | Grade 1 (long life)  |
| Stability grade  | Grade 2  |
| Life time expectancy                                     | Operation life > 300 000 h - failure rate < 5 FIT (40 °C and 0.5 x U <sub>R</sub> )  |
| Marking  | C-value, tolerance code, rated voltage, manufacturer's emblem, code for dielectric material, manufacturer's type designation, year and week, manufacturer's location |

**Notes**

- For more detailed data and test requirements contact [dc-film@vishay.com](mailto:dc-film@vishay.com)
- For general information like characteristics and definitions used for film capacitors follow the link: [www.vishay.com/doc?28147](http://www.vishay.com/doc?28147)
- <sup>(1)</sup> See document "Voltage Proof Test for Metallized Capacitors" ([www.vishay.com/doc?28169](http://www.vishay.com/doc?28169))

| DC VOLTAGE RATINGS |                     |                     |                      |                      |                      |                      |                      |
|--------------------|---------------------|---------------------|----------------------|----------------------|----------------------|----------------------|----------------------|
| U <sub>RDC</sub>   | 700 V <sub>DC</sub> | 850 V <sub>DC</sub> | 1000 V <sub>DC</sub> | 1250 V <sub>DC</sub> | 1600 V <sub>DC</sub> | 2000 V <sub>DC</sub> | 2500 V <sub>DC</sub> |
| U <sub>RAC</sub>   | 420 V <sub>AC</sub> | 450 V <sub>AC</sub> | 500 V <sub>AC</sub>  | 550 V <sub>AC</sub>  | 600 V <sub>AC</sub>  | 700 V <sub>AC</sub>  | 800 V <sub>AC</sub>  |

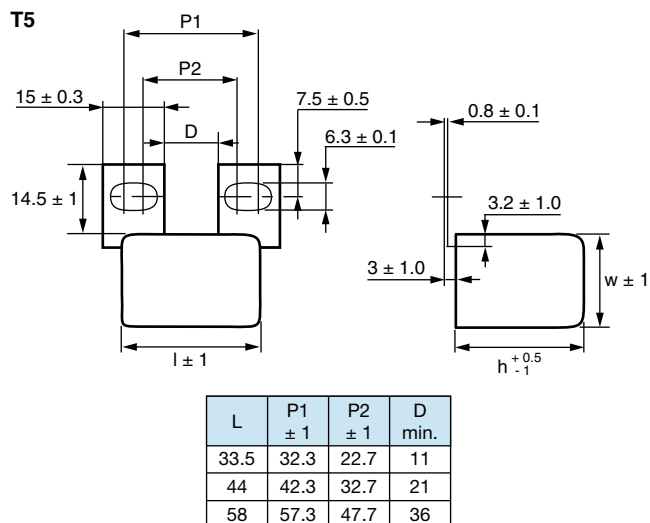
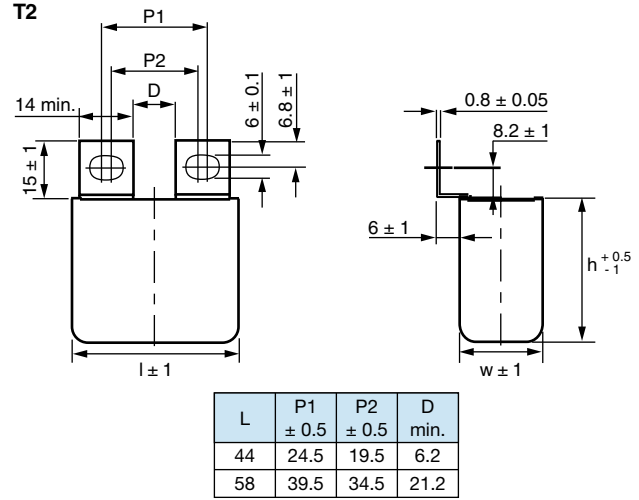
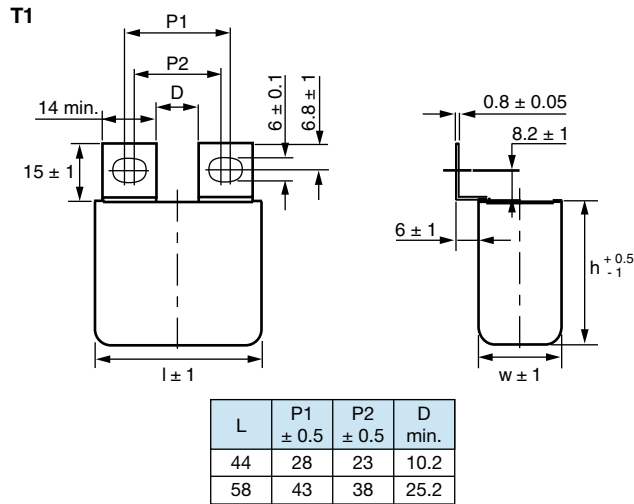
**DIMENSIONS in millimeters AND AVAILABLE TERMINAL VERSIONS**



**COMPOSITION OF CATALOG NUMBER**





| ELECTRICAL DATA AND ORDERING CODE                       |   |                               |      |      |              |                       |                                     |                         |                                   |                                    |                                     |                              |
|---|---|-------------------------------|------|------|--------------|-----------------------|-------------------------------------|-------------------------|-----------------------------------|------------------------------------|-------------------------------------|------------------------------|
| U <sub>RDC</sub> (V)                                    | CAP. (µF)   | DIMENSION (mm) <sup>(4)</sup> |      |      | dU/dt (V/µs) | I <sub>peak</sub> (A) | I <sub>RMS</sub> <sup>(2)</sup> (A) | ESR <sup>(3)</sup> (mΩ) | tan δ 1 kHz < (10 <sup>-4</sup> ) | tan δ 10 kHz < (10 <sup>-4</sup> ) | tan δ 100 kHz < (10 <sup>-4</sup> ) | ORDERING CODE <sup>(1)</sup> |
|   |   | W                             | H    | L    |              |                       |                                     |                         |                                   |                                    |                                     |                              |
| <b>U<sub>RAC</sub> = 420 V; U<sub>pp</sub> = 1130 V</b> |   |                               |      |      |              |                       |                                     |                         |                                   |                                    |                                     |                              |
| 700   | 0.47  | 22.0                          | 30.5 | 33.5 | 800          | 376                   | 7.0                                 | 16.0                    | 4.0                               | 8.0                                | 50                                  | MKP386M447070J**             |
|   | 0.68  | 22.0                          | 30.5 | 33.5 | 800          | 544                   | 8.0                                 | 11.0                    | 4.0                               | 8.0                                | 50                                  | MKP386M468070J**             |
|   | 1.0   | 22.0                          | 30.5 | 33.5 | 800          | 800                   | 9.0                                 | 7.5                     | 4.0                               | 8.0                                | 50                                  | MKP386M510070J**             |
|   | 1.5   | 22.0                          | 30.5 | 33.5 | 800          | 1200                  | 10.0                                | 5.0                     | 4.0                               | 8.0                                | -                                   | MKP386M515070J**             |
|   | 2.0   | 22.0                          | 38.0 | 44.0 | 370          | 740                   | 10.0                                | 7.5                     | 5.0                               | 15.0                               | -                                   | MKP386M520070J**             |
|   | 2.2   | 22.0                          | 38.0 | 44.0 | 370          | 814                   | 10.0                                | 6.5                     | 5.0                               | 15.0                               | -                                   | MKP386M522070J**             |
|   | 3.0   | 30.0                          | 46.0 | 44.0 | 370          | 1110                  | 14.0                                | 5.5                     | 5.0                               | 15.0                               | -                                   | MKP386M530070J**             |
|   | 3.3   | 30.0                          | 46.0 | 44.0 | 370          | 1221                  | 14.0                                | 5.0                     | 5.0                               | 15.0                               | -                                   | MKP386M533070J**             |
|   | 4.0   | 30.0                          | 46.0 | 44.0 | 370          | 1480                  | 15.0                                | 4.5                     | 5.0                               | 15.0                               | -                                   | MKP386M540070J**             |
|   | 4.7   | 30.0                          | 46.0 | 44.0 | 370          | 1739                  | 15.0                                | 6.0                     | 5.0                               | 15.0                               | -                                   | MKP386M547070J**             |
| 5.0   | 30.0  | 46.0                          | 44.0 | 370  | 1850         | 15.0                  | 6.0                                 | 5.0                     | 15.0                              | -                                  | MKP386M550070J**                    |                              |
| <b>U<sub>RAC</sub> = 450 V; U<sub>pp</sub> = 1300 V</b> |   |                               |      |      |              |                       |                                     |                         |                                   |                                    |                                     |                              |
| 850   | 0.47  | 22.0                          | 30.5 | 33.5 | 800          | 376                   | 7.5                                 | 13.0                    | 4.0                               | 8.0                                | 50                                  | MKP386M447085J**             |
|   | 0.68  | 22.0                          | 30.5 | 33.5 | 800          | 544                   | 8.5                                 | 10.0                    | 4.0                               | 8.0                                | 50                                  | MKP386M468085J**             |
|   | 0.82  | 22.0                          | 30.5 | 33.5 | 800          | 656                   | 9.0                                 | 8.5                     | 4.0                               | 8.0                                | 50                                  | MKP386M482085J**             |
|   | 1.0   | 22.0                          | 30.5 | 33.5 | 800          | 800                   | 10.0                                | 7.0                     | 4.0                               | 8.0                                | 50                                  | MKP386M510085J**             |
|   | 1.5   | 22.0                          | 38.0 | 44.0 | 370          | 555                   | 10.0                                | 9.0                     | 5.0                               | 15.0                               | -                                   | MKP386M515085J**             |
|   | 2.0   | 22.0                          | 38.0 | 44.0 | 370          | 740                   | 12.0                                | 7.0                     | 5.0                               | 15.0                               | -                                   | MKP386M520085J**             |
|   | 2.2   | 22.0                          | 38.0 | 44.0 | 370          | 814                   | 13.0                                | 6.0                     | 5.0                               | 15.0                               | -                                   | MKP386M522085J**             |
|   | 3.0   | 30.0                          | 46.0 | 44.0 | 370          | 1110                  | 16.0                                | 4.5                     | 5.0                               | 15.0                               | -                                   | MKP386M530085J**             |
|   | 3.3   | 30.0                          | 46.0 | 44.0 | 370          | 1221                  | 16.0                                | 4.0                     | 5.0                               | 15.0                               | -                                   | MKP386M533085J**             |
|   | 4.0   | 30.0                          | 46.0 | 44.0 | 370          | 1480                  | 18.0                                | 3.5                     | 5.0                               | 15.0                               | -                                   | MKP386M540085J**             |
| <b>U<sub>RAC</sub> = 400 V; U<sub>pp</sub> = 1200 V</b> |   |                               |      |      |              |                       |                                     |                         |                                   |                                    |                                     |                              |
|   | 4.7   | 25.0                          | 45.0 | 58.0 | 170          | 798                   | 17.5                                | 4.0                     | 6.0                               | 25                                 | -                                   | MKP386M547085Y**             |
|   | 5.0   | 25.0                          | 45.0 | 58.0 | 170          | 849                   | 18.0                                | 3.5                     | 6.0                               | 25                                 | -                                   | MKP386M550085Y**             |
|   | 6.0   | 30.0                          | 45.0 | 58.0 | 170          | 1019                  | 20.5                                | 3.0                     | 6.0                               | 25                                 | -                                   | MKP386M560085Y**             |
|   | 7.0   | 30.0                          | 45.0 | 58.0 | 170          | 1189                  | 22.5                                | 2.5                     | 6.0                               | 25                                 | -                                   | MKP386M570085Y**             |
|   | 8.0   | 35.0                          | 50.0 | 58.0 | 170          | 1358                  | 26.0                                | 2.0                     | 6.0                               | 25                                 | -                                   | MKP386M580085Y**             |
|   | 10  | 35.0                          | 50.0 | 58.0 | 170          | 1698                  | 29.0                                | 1.5                     | 6.0                               | 25                                 | -                                   | MKP386M610085Y**             |
|   | <b>U<sub>RAC</sub> = 500 V; U<sub>pp</sub> = 1400 V</b> |                               |      |      |              |                       |                                     |                         |                                   |                                    |                                     |                              |
| 1000  | 0.47  | 22.0                          | 30.5 | 33.5 | 725          | 341                   | 7.5                                 | 13.0                    | 4.0                               | 8.0                                | 50                                  | MKP386M447100J**             |
|   | 0.56  | 22.0                          | 30.5 | 33.5 | 725          | 406                   | 8.0                                 | 11.0                    | 4.0                               | 8.0                                | 50                                  | MKP386M456100J**             |
|   | 0.68  | 22.0                          | 30.5 | 33.5 | 725          | 493                   | 9.0                                 | 9.0                     | 4.0                               | 8.0                                | 50                                  | MKP386M468100J**             |
|   | 0.82  | 22.0                          | 30.5 | 33.5 | 725          | 595                   | 9.0                                 | 7.5                     | 4.0                               | 8.0                                | 50                                  | MKP386M482100J**             |
|   | 1.0   | 22.0                          | 30.5 | 33.5 | 725          | 725                   | 10.0                                | 6.0                     | 4.0                               | 8.0                                | 50                                  | MKP386M510100J**             |
|   | 1.2   | 22.0                          | 38.0 | 44.0 | 340          | 408                   | 10.0                                | 10.0                    | 5.0                               | 15.0                               | -                                   | MKP386M512100J**             |
|   | 1.5   | 22.0                          | 38.0 | 44.0 | 340          | 510                   | 11.0                                | 8.0                     | 5.0                               | 15.0                               | -                                   | MKP386M515100J**             |
|   | 1.8   | 22.0                          | 38.0 | 44.0 | 340          | 612                   | 12.0                                | 6.5                     | 5.0                               | 15.0                               | -                                   | MKP386M518100J**             |
|   | 2.0   | 30.0                          | 46.0 | 44.0 | 340          | 680                   | 14.0                                | 6.0                     | 5.0                               | 15.0                               | -                                   | MKP386M520100J**             |
|   | 2.2   | 30.0                          | 46.0 | 44.0 | 340          | 748                   | 15.0                                | 5.5                     | 5.0                               | 15.0                               | -                                   | MKP386M522100J**             |
|   | 2.5   | 30.0                          | 46.0 | 44.0 | 340          | 850                   | 15.0                                | 5.0                     | 5.0                               | 15.0                               | -                                   | MKP386M525100J**             |
|   | 2.7   | 30.0                          | 46.0 | 44.0 | 340          | 918                   | 16.0                                | 4.5                     | 5.0                               | 15.0                               | -                                   | MKP386M527100J**             |
|   | 3.3   | 30.0                          | 46.0 | 44.0 | 340          | 1122                  | 18.0                                | 3.5                     | 5.0                               | 15.0                               | -                                   | MKP386M533100J**             |
| <b>U<sub>RAC</sub> = 425 V; U<sub>pp</sub> = 1200 V</b> |   |                               |      |      |              |                       |                                     |                         |                                   |                                    |                                     |                              |
|   | 3.3   | 25.0                          | 45.0 | 58.0 | 205          | 677                   | 16.0                                | 4.5                     | 7.5                               | 25                                 | -                                   | MKP386M533100Y**             |
|   | 4.0   | 25.0                          | 45.0 | 58.0 | 205          | 820                   | 17.5                                | 3.5                     | 7.5                               | 25                                 | -                                   | MKP386M540100Y**             |
|   | 4.7   | 30.0                          | 45.0 | 58.0 | 205          | 964                   | 20.0                                | 3.0                     | 7.5                               | 25                                 | -                                   | MKP386M547100Y**             |
|   | 5.0   | 30.0                          | 45.0 | 58.0 | 205          | 1025                  | 21.0                                | 3.0                     | 7.5                               | 25                                 | -                                   | MKP386M550100Y**             |
|   | 6.0   | 35.0                          | 50.0 | 58.0 | 205          | 1230                  | 24.5                                | 2.5                     | 7.5                               | 25                                 | -                                   | MKP386M560100Y**             |
|   | 7.0   | 35.0                          | 50.0 | 58.0 | 205          | 1435                  | 26.5                                | 2.0                     | 7.5                               | 25                                 | -                                   | MKP386M570100Y**             |



| ELECTRICAL DATA AND ORDERING CODE |  |                               |      |      |              |                       |                                     |                         |                                   |                                    |                                     |                              |
|-----------------------------------|--|-------------------------------|------|------|--------------|-----------------------|-------------------------------------|-------------------------|-----------------------------------|------------------------------------|-------------------------------------|------------------------------|
| U <sub>RDC</sub> (V)              | CAP. (µF)  | DIMENSION (mm) <sup>(4)</sup> |      |      | dU/dt (V/µs) | I <sub>peak</sub> (A) | I <sub>RMS</sub> <sup>(2)</sup> (A) | ESR <sup>(3)</sup> (mΩ) | tan δ 1 kHz < (10 <sup>-4</sup> ) | tan δ 10 kHz < (10 <sup>-4</sup> ) | tan δ 100 kHz < (10 <sup>-4</sup> ) | ORDERING CODE <sup>(1)</sup> |
|                                   |  | W                             | H    | L    |              |                       |                                     |                         |                                   |                                    |                                     |                              |
| 1250                              | U <sub>RAC</sub> = 550 V; U <sub>pp</sub> = 1550 V |                               |      |      |              |                       |                                     |                         |                                   |                                    |                                     |                              |
|                                   | 0.33   | 22.0                          | 30.5 | 33.5 | 800          | 264                   | 7.0                                 | 16.0                    | 4.0                               | 8.0                                | 40                                  | MKP386M433125J**             |
|                                   | 0.39   | 22.0                          | 30.5 | 33.5 | 800          | 312                   | 7.0                                 | 14.0                    | 4.0                               | 8.0                                | 40                                  | MKP386M439125J**             |
|                                   | 0.47   | 22.0                          | 30.5 | 33.5 | 800          | 376                   | 8.0                                 | 11.0                    | 4.0                               | 8.0                                | 40                                  | MKP386M447125J**             |
|                                   | 0.56   | 22.0                          | 30.5 | 33.5 | 800          | 448                   | 8.5                                 | 10.0                    | 4.0                               | 8.0                                | 40                                  | MKP386M456125J**             |
|                                   | 0.68   | 22.0                          | 30.5 | 33.5 | 800          | 544                   | 9.5                                 | 8.0                     | 4.0                               | 8.0                                | 40                                  | MKP386M468125J**             |
|                                   | 0.82   | 22.0                          | 38.0 | 44.0 | 375          | 308                   | 9.0                                 | 13.0                    | 5.0                               | 15.0                               | 60                                  | MKP386M482125J**             |
|                                   | 1.0  | 22.0                          | 38.0 | 44.0 | 375          | 375                   | 10.0                                | 10.0                    | 5.0                               | 15.0                               | 60                                  | MKP386M510125J**             |
|                                   | 1.2  | 22.0                          | 38.0 | 44.0 | 375          | 450                   | 11.0                                | 9.0                     | 5.0                               | 15.0                               | -                                   | MKP386M512125J**             |
|                                   | 1.5  | 30.0                          | 46.0 | 44.0 | 375          | 563                   | 14.0                                | 7.0                     | 5.0                               | 15.0                               | -                                   | MKP386M515125J**             |
|                                   | 1.8  | 30.0                          | 46.0 | 44.0 | 375          | 675                   | 15.0                                | 6.0                     | 5.0                               | 15.0                               | -                                   | MKP386M518125J**             |
|                                   | 2.0  | 30.0                          | 46.0 | 44.0 | 375          | 750                   | 16.0                                | 5.5                     | 5.0                               | 15.0                               | -                                   | MKP386M520125J**             |
|                                   | 2.2  | 30.0                          | 46.0 | 44.0 | 375          | 825                   | 18.0                                | 4.5                     | 5.0                               | 15.0                               | -                                   | MKP386M522125J**             |
|                                   | U <sub>RAC</sub> = 450 V; U <sub>pp</sub> = 1300 V |                               |      |      |              |                       |                                     |                         |                                   |                                    |                                     |                              |
|                                   | 2.2  | 25.0                          | 45.0 | 58.0 | 225          | 495                   | 14.0                                | 6.0                     | 7.5                               | 20                                 | -                                   | MKP386M522125Y**             |
|                                   | 2.5  | 25.0                          | 45.0 | 58.0 | 225          | 563                   | 15.0                                | 5.0                     | 7.5                               | 20                                 | -                                   | MKP386M525125Y**             |
|                                   | 3.0  | 25.0                          | 45.0 | 58.0 | 225          | 675                   | 16.5                                | 4.0                     | 7.5                               | 20                                 | -                                   | MKP386M530125Y**             |
|                                   | 3.3  | 30.0                          | 45.0 | 58.0 | 225          | 743                   | 18.0                                | 4.0                     | 7.5                               | 20                                 | -                                   | MKP386M533125Y**             |
|                                   | 4.0  | 35.0                          | 50.0 | 58.0 | 225          | 900                   | 21.5                                | 3.0                     | 7.5                               | 20                                 | -                                   | MKP386M540125Y**             |
|                                   | 4.7  | 35.0                          | 50.0 | 58.0 | 225          | 1058                  | 23.5                                | 2.5                     | 7.5                               | 20                                 | -                                   | MKP386M547125Y**             |
| 5.0                               | 35.0   | 50.0                          | 58.0 | 225  | 1125         | 24.5                  | 2.5                                 | 7.5                     | 20                                | -                                  | MKP386M550125Y**                    |                              |
| 1600                              | U <sub>RAC</sub> = 600 V; U <sub>pp</sub> = 1690 V |                               |      |      |              |                       |                                     |                         |                                   |                                    |                                     |                              |
|                                   | 0.22   | 22.0                          | 30.5 | 33.5 | 800          | 176                   | 7.0                                 | 16.0                    | 3.0                               | 5.0                                | 40                                  | MKP386M422160J**             |
|                                   | 0.27   | 22.0                          | 30.5 | 33.5 | 800          | 216                   | 7.0                                 | 15.0                    | 3.0                               | 5.0                                | 40                                  | MKP386M427160J**             |
|                                   | 0.33   | 22.0                          | 30.5 | 33.5 | 800          | 264                   | 8.0                                 | 12.0                    | 3.0                               | 5.0                                | 40                                  | MKP386M433160J**             |
|                                   | 0.39   | 22.0                          | 30.5 | 33.5 | 800          | 312                   | 8.5                                 | 10.0                    | 3.0                               | 5.0                                | 40                                  | MKP386M439160J**             |
|                                   | 0.47   | 22.0                          | 30.5 | 33.5 | 800          | 376                   | 9.0                                 | 8.5                     | 3.0                               | 5.0                                | 40                                  | MKP386M447160J**             |
|                                   | 0.56   | 22.0                          | 38.0 | 44.0 | 375          | 210                   | 9.0                                 | 14.0                    | 4.0                               | 10.0                               | 60                                  | MKP386M456160J**             |
|                                   | 0.68   | 22.0                          | 38.0 | 44.0 | 375          | 255                   | 9.0                                 | 12.0                    | 4.0                               | 10.0                               | 60                                  | MKP386M468160J**             |
|                                   | 0.82   | 22.0                          | 38.0 | 44.0 | 375          | 308                   | 10.0                                | 10.0                    | 4.0                               | 10.0                               | 60                                  | MKP386M482160J**             |
|                                   | 1.0  | 22.0                          | 38.0 | 44.0 | 375          | 375                   | 12.0                                | 8.0                     | 4.0                               | 10.0                               | 60                                  | MKP386M510160J**             |
|                                   | 1.3  | 30.0                          | 46.0 | 44.0 | 375          | 488                   | 16.0                                | 6.0                     | 4.0                               | 10.0                               | -                                   | MKP386M513160J**             |
|                                   | 1.5  | 30.0                          | 46.0 | 44.0 | 375          | 563                   | 16.0                                | 5.5                     | 4.0                               | 10.0                               | -                                   | MKP386M515160J**             |
|                                   | 1.8  | 30.0                          | 46.0 | 44.0 | 375          | 675                   | 18.0                                | 4.5                     | 4.0                               | 10.0                               | -                                   | MKP386M518160J**             |
|                                   | 2.0  | 30.0                          | 46.0 | 44.0 | 375          | 750                   | 19.0                                | 4.0                     | 4.0                               | 10.0                               | -                                   | MKP386M520160K**             |
|                                   | U <sub>RAC</sub> = 450 V; U <sub>pp</sub> = 1300 V |                               |      |      |              |                       |                                     |                         |                                   |                                    |                                     |                              |
|                                   | 1.5  | 25.0                          | 45.0 | 58.0 | 360          | 540                   | 18.0                                | 3.5                     | 5.0                               | 15                                 | -                                   | MKP386M515160Y**             |
| 2.0                               | 30.0   | 45.0                          | 58.0 | 360  | 720          | 22.0                  | 2.5                                 | 5.0                     | 15                                | -                                  | MKP386M520160Y**                    |                              |
| 2.2                               | 35.0   | 50.0                          | 58.0 | 360  | 792          | 25.0                  | 2.5                                 | 5.0                     | 15                                | -                                  | MKP386M522160Y**                    |                              |
| 2.5                               | 35.0   | 50.0                          | 58.0 | 360  | 900          | 26.5                  | 2.0                                 | 5.0                     | 15                                | -                                  | MKP386M525160Y**                    |                              |
| 2000                              | U <sub>RAC</sub> = 700 V; U <sub>pp</sub> = 1980 V |                               |      |      |              |                       |                                     |                         |                                   |                                    |                                     |                              |
|                                   | 0.047  | 22.0                          | 30.5 | 33.5 | 2000         | 94                    | 6.0                                 | 20.0                    | 3.0                               | 5.0                                | 30                                  | MKP386M347200J**             |
|                                   | 0.068  | 22.0                          | 30.5 | 33.5 | 2000         | 136                   | 6.5                                 | 17.0                    | 3.0                               | 5.0                                | 30                                  | MKP386M368200J**             |
|                                   | 0.10   | 22.0                          | 30.5 | 33.5 | 2000         | 200                   | 8.0                                 | 11.0                    | 3.0                               | 5.0                                | 30                                  | MKP386M410200J**             |
|                                   | 0.12   | 22.0                          | 30.5 | 33.5 | 2000         | 240                   | 9.0                                 | 9.0                     | 3.0                               | 5.0                                | 30                                  | MKP386M412200J**             |
|                                   | 0.15   | 22.0                          | 30.5 | 33.5 | 2000         | 300                   | 9.5                                 | 8.0                     | 3.0                               | 5.0                                | 30                                  | MKP386M415200J**             |
|                                   | 0.22   | 22.0                          | 38.0 | 44.0 | 850          | 187                   | 10.0                                | 10.0                    | 4.0                               | 10.0                               | 50                                  | MKP386M422200J**             |
|                                   | 0.27   | 22.0                          | 38.0 | 44.0 | 850          | 230                   | 11.0                                | 8.5                     | 4.0                               | 10.0                               | 50                                  | MKP386M427200J**             |
|                                   | 0.33   | 22.0                          | 38.0 | 44.0 | 850          | 281                   | 12.0                                | 7.0                     | 4.0                               | 10.0                               | 50                                  | MKP386M433200J**             |
|                                   | 0.39   | 22.0                          | 38.0 | 44.0 | 850          | 332                   | 12.0                                | 6.0                     | 4.0                               | 10.0                               | 50                                  | MKP386M439200J**             |
|                                   | 0.47   | 30.0                          | 46.0 | 44.0 | 850          | 400                   | 16.0                                | 5.0                     | 4.0                               | 10.0                               | 50                                  | MKP386M447200J**             |
|                                   | 0.56   | 30.0                          | 46.0 | 44.0 | 850          | 476                   | 18.0                                | 4.0                     | 4.0                               | 10.0                               | 50                                  | MKP386M456200J**             |
|                                   | 0.68   | 30.0                          | 46.0 | 44.0 | 850          | 578                   | 20.0                                | 3.5                     | 4.0                               | 10.0                               | 50                                  | MKP386M468200J**             |
|                                   | 0.68   | 25.0                          | 45.0 | 58.0 | 525          | 357                   | 14.0                                | 6.0                     | 5.0                               | 15.0                               | 75                                  | MKP386M468200Y**             |
|                                   | 0.82   | 25.0                          | 45.0 | 58.0 | 525          | 431                   | 15.5                                | 5.0                     | 5.0                               | 15.0                               | 75                                  | MKP386M482200Y**             |
| 1.0                               | 30.0   | 45.0                          | 58.0 | 525  | 525          | 18.0                  | 4.0                                 | 5.0                     | 15.0                              | -                                  | MKP386M510200Y**                    |                              |
| 1.5                               | 35.0   | 50.0                          | 58.0 | 525  | 788          | 24.0                  | 2.5                                 | 5.0                     | 15.0                              | -                                  | MKP386M515200Y**                    |                              |



| ELECTRICAL DATA AND ORDERING CODE                  |           |                               |      |      |              |                       |                                     |                         |                                   |                                    |                                     |                              |
|--|-----------|-------------------------------|------|------|--------------|-----------------------|-------------------------------------|-------------------------|-----------------------------------|------------------------------------|-------------------------------------|------------------------------|
| U <sub>RDC</sub> (V)                               | CAP. (μF) | DIMENSION (mm) <sup>(4)</sup> |      |      | dU/dt (V/μs) | I <sub>peak</sub> (A) | I <sub>RMS</sub> <sup>(2)</sup> (A) | ESR <sup>(3)</sup> (mΩ) | tan δ 1 kHz < (10 <sup>-4</sup> ) | tan δ 10 kHz < (10 <sup>-4</sup> ) | tan δ 100 kHz < (10 <sup>-4</sup> ) | ORDERING CODE <sup>(1)</sup> |
|  |           | W                             | H    | L    |              |                       |                                     |                         |                                   |                                    |                                     |                              |
| U <sub>RAC</sub> = 800 V; U <sub>pp</sub> = 2260 V |           |                               |      |      |              |                       |                                     |                         |                                   |                                    |                                     |                              |
| 2500   | 0.047     | 22.0                          | 30.5 | 33.5 | 2500         | 118                   | 6.0                                 | 20.0                    | 3.0                               | 5.0                                | 30                                  | MKP386M347250J**             |
|  | 0.068     | 22.0                          | 30.5 | 33.5 | 2500         | 170                   | 7.0                                 | 14.0                    | 3.0                               | 5.0                                | 30                                  | MKP386M368250J**             |
|  | 0.10      | 22.0                          | 30.5 | 33.5 | 2500         | 250                   | 8.5                                 | 10.0                    | 3.0                               | 5.0                                | 30                                  | MKP386M410250J**             |
|  | 0.12      | 22.0                          | 30.5 | 33.5 | 2500         | 300                   | 9.5                                 | 8.0                     | 3.0                               | 5.0                                | 30                                  | MKP386M412250J**             |
|  | 0.15      | 22.0                          | 38.0 | 44.0 | 1000         | 150                   | 9.5                                 | 12.5                    | 4.0                               | 10.0                               | 50                                  | MKP386M415250J**             |
|  | 0.18      | 22.0                          | 38.0 | 44.0 | 1000         | 180                   | 10.0                                | 11.0                    | 4.0                               | 10.0                               | 50                                  | MKP386M418250J**             |
|  | 0.22      | 22.0                          | 38.0 | 44.0 | 1000         | 220                   | 11.0                                | 8.5                     | 4.0                               | 10.0                               | 50                                  | MKP386M422250J**             |
|  | 0.33      | 30.0                          | 46.0 | 44.0 | 1000         | 330                   | 15.0                                | 6.0                     | 4.0                               | 10.0                               | 50                                  | MKP386M433250J**             |
|  | 0.39      | 30.0                          | 46.0 | 44.0 | 1000         | 390                   | 16.0                                | 5.0                     | 4.0                               | 10.0                               | 50                                  | MKP386M439250J**             |
|  | 0.47      | 30.0                          | 46.0 | 44.0 | 1000         | 470                   | 18.0                                | 4.0                     | 4.0                               | 10.0                               | 50                                  | MKP386M447250J**             |
|  | 0.47      | 25.0                          | 45.0 | 58.0 | 795          | 374                   | 15.0                                | 5.5                     | 5.0                               | 15.0                               | 75                                  | MKP386M447250Y**             |
|  | 0.56      | 30.0                          | 45.0 | 58.0 | 795          | 445                   | 17.0                                | 4.5                     | 5.0                               | 15.0                               | 75                                  | MKP386M456250Y**             |
|  | 0.68      | 35.0                          | 50.0 | 58.0 | 795          | 541                   | 20.5                                | 4.0                     | 5.0                               | 15.0                               | 75                                  | MKP386M468250Y**             |
| 0.82   | 35.0      | 50.0                          | 58.0 | 795  | 652          | 22.5                  | 3.0                                 | 5.0                     | 15.0                              | 75                                 | MKP386M482250Y**                    |                              |

**Notes**

- (1) Change the symbol \*\* according special code for the terminals (see Packaging Information table)
- (2) Maximum RMS current at 100 kHz, + 85 °C
- (3) The ESR (Equivalent Series Resistance) typical values at 100 kHz
- (4) Standard dimension

| PACKAGING INFORMATION |                  |                              |          |                                |    |    |    |    |    |    |    |
|-----------------------|------------------|------------------------------|----------|--------------------------------|----|----|----|----|----|----|----|
| U <sub>RDC</sub> (V)  | CAP. (μF)        | ORDERING CODE <sup>(1)</sup> | MASS (g) | TERMINAL AVAILABLE - SPQ (pcs) |    |    |    |    |    |    |    |
|                       |                  |                              |          | T1                             | T2 | T3 | T4 | T5 | T6 | T7 | T8 |
| 700                   | 0.47             | MKP386M447070J**             | 41       |                                |    | 48 |    | 48 |    | 55 |    |
|                       | 0.68             | MKP386M468070J**             | 39       |                                |    | 48 |    | 48 |    | 55 |    |
|                       | 1.0              | MKP386M510070J**             | 38       |                                |    | 48 |    | 48 |    | 55 |    |
|                       | 1.5              | MKP386M515070J**             | 35       |                                |    | 48 |    | 48 |    | 55 |    |
|                       | 2.0              | MKP386M520070J**             | 59       | 42                             | 42 | 36 | 42 | 36 | 42 | 36 | 42 |
|                       | 2.2              | MKP386M522070J**             | 57       | 42                             | 42 | 36 | 42 | 36 | 42 | 36 | 42 |
|                       | 3.0              | MKP386M530070J**             | 91       | 63                             | 63 | 54 | 63 | 60 | 63 | 60 | 63 |
|                       | 3.3              | MKP386M533070J**             | 89       | 63                             | 63 | 54 | 63 | 60 | 63 | 60 | 63 |
|                       | 4.0              | MKP386M540070J**             | 86       | 63                             | 63 | 54 | 63 | 60 | 63 | 60 | 63 |
|                       | 4.7              | MKP386M547070J**             | 82       | 63                             | 63 | 54 | 63 | 60 | 63 | 60 | 63 |
| 850                   | 5.0              | MKP386M550070J**             | 80       | 63                             | 63 | 54 | 63 | 60 | 63 | 60 | 63 |
|                       | 0.47             | MKP386M447085J**             | 40       |                                |    | 48 |    | 48 |    | 55 |    |
|                       | 0.68             | MKP386M468085J**             | 39       |                                |    | 48 |    | 48 |    | 55 |    |
|                       | 0.82             | MKP386M482085J**             | 38       |                                |    | 48 |    | 48 |    | 55 |    |
|                       | 1.0              | MKP386M510085J**             | 36       |                                |    | 48 |    | 48 |    | 55 |    |
|                       | 1.5              | MKP386M515085J**             | 60       | 42                             | 42 | 36 | 42 | 36 | 42 | 36 | 42 |
|                       | 2.0              | MKP386M520085J**             | 56       | 42                             | 42 | 36 | 42 | 36 | 42 | 36 | 42 |
|                       | 2.2              | MKP386M522085J**             | 55       | 42                             | 42 | 36 | 42 | 36 | 42 | 36 | 42 |
|                       | 3.0              | MKP386M530085J**             | 88       | 63                             | 63 | 54 | 63 | 60 | 63 | 60 | 63 |
|                       | 3.3              | MKP386M533085J**             | 86       | 63                             | 63 | 54 | 63 | 60 | 63 | 60 | 63 |
|                       | 4.0              | MKP386M540085J**             | 86       | 63                             | 63 | 54 | 63 | 60 | 63 | 60 | 63 |
|                       | 4.7              | MKP386M547085Y**             | 79       | 50                             | 50 | 48 | 55 | 55 | 55 | 50 | 50 |
|                       | 5.0              | MKP386M550085Y**             | 78       | 50                             | 50 | 48 | 55 | 55 | 55 | 50 | 50 |
|                       | 6.0              | MKP386M560085Y**             | 93       | 45                             | 45 | 40 | 45 | 45 | 45 | 45 | 45 |
|                       | 7.0              | MKP386M570085Y**             | 90       | 45                             | 45 | 40 | 45 | 45 | 45 | 45 | 45 |
| 8.0                   | MKP386M580085Y** | 121                          | 35       | 35                             | 36 | 40 | 40 | 40 | 35 | 35 |    |
| 10                    | MKP386M610085Y** | 114                          | 35       | 35                             | 36 | 40 | 40 | 40 | 35 | 35 |    |



| PACKAGING INFORMATION   |                  |                   |             |                                |    |    |    |    |    |    |    |
|-------------------------|------------------|-------------------|-------------|--------------------------------|----|----|----|----|----|----|----|
| U <sub>RDC</sub><br>(V) | CAP.<br>(µF)     | ORDERING CODE (1) | MASS<br>(g) | TERMINAL AVAILABLE - SPQ (pcs) |    |    |    |    |    |    |    |
|                         |                  |                   |             | T1                             | T2 | T3 | T4 | T5 | T6 | T7 | T8 |
| 1000                    | 0.47             | MKP386M447100J**  | 39          |                                |    | 48 |    | 48 |    | 55 |    |
|                         | 0.56             | MKP386M456100J**  | 39          |                                |    | 48 |    | 48 |    | 55 |    |
|                         | 0.68             | MKP386M468100J**  | 38          |                                |    | 48 |    | 48 |    | 55 |    |
|                         | 0.82             | MKP386M482100J**  | 37          |                                |    | 48 |    | 48 |    | 55 |    |
|                         | 1.0              | MKP386M510100J**  | 35          |                                |    | 48 |    | 48 |    | 55 |    |
|                         | 1.2              | MKP386M512100J**  | 60          | 42                             | 42 | 36 | 42 | 36 | 42 | 36 | 42 |
|                         | 1.5              | MKP386M515100J**  | 58          | 42                             | 42 | 36 | 42 | 36 | 42 | 36 | 42 |
|                         | 1.8              | MKP386M518100J**  | 56          | 42                             | 42 | 36 | 42 | 36 | 42 | 36 | 42 |
|                         | 2.0              | MKP386M520100J**  | 92          | 63                             | 63 | 54 | 63 | 60 | 63 | 60 | 63 |
|                         | 2.2              | MKP386M522100J**  | 90          | 63                             | 63 | 54 | 63 | 60 | 63 | 60 | 63 |
|                         | 2.5              | MKP386M525100J**  | 88          | 63                             | 63 | 54 | 63 | 60 | 63 | 60 | 63 |
|                         | 2.7              | MKP386M527100J**  | 86          | 63                             | 63 | 54 | 63 | 60 | 63 | 60 | 63 |
|                         | 3.3              | MKP386M533100J**  | 81          | 63                             | 63 | 54 | 63 | 60 | 63 | 60 | 63 |
|                         | 3.3              | MKP386M533100Y**  | 78          | 50                             | 50 | 48 | 55 | 55 | 55 | 50 | 50 |
|                         | 4.0              | MKP386M540100Y**  | 75          | 50                             | 50 | 48 | 55 | 55 | 55 | 50 | 50 |
|                         | 4.7              | MKP386M547100Y**  | 90          | 45                             | 45 | 40 | 45 | 45 | 45 | 45 | 45 |
| 5.0                     | MKP386M550100Y** | 89                | 45          | 45                             | 40 | 45 | 45 | 45 | 45 | 45 |    |
| 6.0                     | MKP386M560100Y** | 119               | 35          | 35                             | 36 | 40 | 40 | 40 | 35 | 35 |    |
| 7.0                     | MKP386M570100Y** | 114               | 35          | 35                             | 36 | 40 | 40 | 40 | 35 | 35 |    |
| 1250                    | 0.33             | MKP386M433125J**  | 40          |                                |    | 48 |    | 48 |    | 55 |    |
|                         | 0.39             | MKP386M439125J**  | 39          |                                |    | 48 |    | 48 |    | 55 |    |
|                         | 0.47             | MKP386M447125J**  | 38          |                                |    | 48 |    | 48 |    | 55 |    |
|                         | 0.56             | MKP386M456125J**  | 37          |                                |    | 48 |    | 48 |    | 55 |    |
|                         | 0.68             | MKP386M468125J**  | 36          |                                |    | 48 |    | 48 |    | 55 |    |
|                         | 0.82             | MKP386M482125J**  | 60          | 42                             | 42 | 36 | 42 | 36 | 42 | 36 | 42 |
|                         | 1.0              | MKP386M510125J**  | 59          | 42                             | 42 | 36 | 42 | 36 | 42 | 36 | 42 |
|                         | 1.2              | MKP386M512125J**  | 56          | 42                             | 42 | 36 | 42 | 36 | 42 | 36 | 42 |
|                         | 1.5              | MKP386M515125J**  | 91          | 63                             | 63 | 54 | 63 | 60 | 63 | 60 | 63 |
|                         | 1.8              | MKP386M518125J**  | 88          | 63                             | 63 | 54 | 63 | 60 | 63 | 60 | 63 |
|                         | 2.0              | MKP386M520125J**  | 86          | 63                             | 63 | 54 | 63 | 60 | 63 | 60 | 63 |
|                         | 2.2              | MKP386M522125J**  | 84          | 63                             | 63 | 54 | 63 | 60 | 63 | 60 | 63 |
|                         | 2.2              | MKP386M522125Y**  | 81          | 50                             | 50 | 48 | 55 | 55 | 55 | 50 | 50 |
|                         | 2.5              | MKP386M525125Y**  | 79          | 50                             | 50 | 48 | 55 | 55 | 55 | 50 | 50 |
|                         | 3.0              | MKP386M530125Y**  | 76          | 50                             | 50 | 48 | 55 | 55 | 55 | 50 | 50 |
|                         | 3.3              | MKP386M533125Y**  | 93          | 45                             | 45 | 40 | 45 | 45 | 45 | 45 | 45 |
| 4.0                     | MKP386M540125Y** | 123               | 35          | 35                             | 36 | 40 | 40 | 40 | 35 | 35 |    |
| 4.7                     | MKP386M547125Y** | 119               | 35          | 35                             | 36 | 40 | 40 | 40 | 35 | 35 |    |
| 5.0                     | MKP386M550125Y** | 116               | 35          | 35                             | 36 | 40 | 40 | 40 | 35 | 35 |    |
| 1600                    | 0.22             | MKP386M422160J**  | 40          |                                |    | 48 |    | 48 |    | 55 |    |
|                         | 0.27             | MKP386M427160J**  | 39          |                                |    | 48 |    | 48 |    | 55 |    |
|                         | 0.33             | MKP386M433160J**  | 38          |                                |    | 48 |    | 48 |    | 55 |    |
|                         | 0.39             | MKP386M439160J**  | 37          |                                |    | 48 |    | 48 |    | 55 |    |
|                         | 0.47             | MKP386M447160J**  | 35          |                                |    | 48 |    | 48 |    | 55 |    |
|                         | 0.56             | MKP386M456160J**  | 61          | 42                             | 42 | 36 | 42 | 36 | 42 | 36 | 42 |
|                         | 0.68             | MKP386M468160J**  | 59          | 42                             | 42 | 36 | 42 | 36 | 42 | 36 | 42 |
|                         | 0.82             | MKP386M482160J**  | 57          | 42                             | 42 | 36 | 42 | 36 | 42 | 36 | 42 |
|                         | 1.0              | MKP386M510160J**  | 54          | 42                             | 42 | 36 | 42 | 36 | 42 | 36 | 42 |
|                         | 1.3              | MKP386M513160J**  | 87          | 63                             | 63 | 54 | 63 | 60 | 63 | 60 | 63 |
|                         | 1.5              | MKP386M515160J**  | 84          | 63                             | 63 | 54 | 63 | 60 | 63 | 60 | 63 |
|                         | 1.8              | MKP386M518160J**  | 79          | 63                             | 63 | 54 | 63 | 60 | 63 | 60 | 63 |
|                         | 2.0              | MKP386M520160K**  | 76          | 63                             | 63 | 54 | 63 | 60 | 63 | 60 | 63 |
|                         | 1.5              | MKP386M515160Y**  | 75          | 50                             | 50 | 48 | 55 | 55 | 55 | 50 | 50 |
|                         | 2.0              | MKP386M520160Y**  | 87          | 45                             | 45 | 40 | 45 | 45 | 45 | 45 | 45 |
|                         | 2.2              | MKP386M522160Y**  | 119         | 35                             | 35 | 36 | 40 | 40 | 40 | 35 | 35 |
| 2.5                     | MKP386M525160Y** | 115               | 35          | 35                             | 36 | 40 | 40 | 40 | 35 | 35 |    |

| PACKAGING INFORMATION   |                  |                   |             |                                |    |    |    |    |    |    |    |
|-------------------------|------------------|-------------------|-------------|--------------------------------|----|----|----|----|----|----|----|
| U <sub>RDC</sub><br>(V) | CAP.<br>(μF)     | ORDERING CODE (1) | MASS<br>(g) | TERMINAL AVAILABLE - SPQ (pcs) |    |    |    |    |    |    |    |
|                         |                  |                   |             | T1                             | T2 | T3 | T4 | T5 | T6 | T7 | T8 |
| 2000                    | 0.047            | MKP386M347200J**  | 41          |                                |    | 48 |    | 48 |    | 55 |    |
|                         | 0.068            | MKP386M368200J**  | 40          |                                |    | 48 |    | 48 |    | 55 |    |
|                         | 0.10             | MKP386M410200J**  | 39          |                                |    | 48 |    | 48 |    | 55 |    |
|                         | 0.12             | MKP386M412200J**  | 38          |                                |    | 48 |    | 48 |    | 55 |    |
|                         | 0.15             | MKP386M415200J**  | 37          |                                |    | 48 |    | 48 |    | 55 |    |
|                         | 0.22             | MKP386M422200J**  | 61          | 42                             | 42 | 36 | 42 | 36 | 42 | 36 | 42 |
|                         | 0.27             | MKP386M427200J**  | 59          | 42                             | 42 | 36 | 42 | 36 | 42 | 36 | 42 |
|                         | 0.33             | MKP386M433200J**  | 57          | 42                             | 42 | 36 | 42 | 36 | 42 | 36 | 42 |
|                         | 0.39             | MKP386M439200J**  | 55          | 42                             | 42 | 36 | 42 | 36 | 42 | 36 | 42 |
|                         | 0.47             | MKP386M447200J**  | 90          | 63                             | 63 | 54 | 63 | 60 | 63 | 60 | 63 |
|                         | 0.56             | MKP386M456200J**  | 87          | 63                             | 63 | 54 | 63 | 60 | 63 | 60 | 63 |
|                         | 0.68             | MKP386M468200J**  | 82          | 63                             | 63 | 54 | 63 | 60 | 63 | 60 | 63 |
|                         | 0.68             | MKP386M468200Y**  | 78          | 50                             | 50 | 48 | 55 | 55 | 55 | 50 | 50 |
|                         | 0.82             | MKP386M482200Y**  | 75          | 50                             | 50 | 48 | 55 | 55 | 55 | 50 | 50 |
| 1.0                     | MKP386M510200Y** | 89                | 45          | 45                             | 40 | 45 | 45 | 45 | 45 | 45 |    |
| 1.5                     | MKP386M515200Y** | 112               | 35          | 35                             | 36 | 40 | 40 | 40 | 35 | 35 |    |
| 2500                    | 0.047            | MKP386M347250J**  | 40          |                                |    | 48 |    | 48 |    | 55 |    |
|                         | 0.068            | MKP386M368250J**  | 39          |                                |    | 48 |    | 48 |    | 55 |    |
|                         | 0.10             | MKP386M410250J**  | 37          |                                |    | 48 |    | 48 |    | 55 |    |
|                         | 0.12             | MKP386M412250J**  | 36          |                                |    | 48 |    | 48 |    | 55 |    |
|                         | 0.15             | MKP386M415250J**  | 61          | 42                             | 42 | 36 | 42 | 36 | 42 | 36 | 42 |
|                         | 0.18             | MKP386M418250J**  | 59          | 42                             | 42 | 36 | 42 | 36 | 42 | 36 | 42 |
|                         | 0.22             | MKP386M422250J**  | 57          | 42                             | 42 | 36 | 42 | 36 | 42 | 36 | 42 |
|                         | 0.33             | MKP386M433250J**  | 88          | 63                             | 63 | 54 | 63 | 60 | 63 | 60 | 63 |
|                         | 0.39             | MKP386M439250J**  | 85          | 63                             | 63 | 54 | 63 | 60 | 63 | 60 | 63 |
|                         | 0.47             | MKP386M447250J**  | 80          | 63                             | 63 | 54 | 63 | 60 | 63 | 60 | 63 |
|                         | 0.47             | MKP386M447250Y**  | 74          | 50                             | 50 | 48 | 55 | 55 | 55 | 50 | 50 |
|                         | 0.56             | MKP386M456250Y**  | 89          | 45                             | 45 | 40 | 45 | 45 | 45 | 45 | 45 |
|                         | 0.68             | MKP386M468250Y**  | 119         | 35                             | 35 | 36 | 40 | 40 | 40 | 35 | 35 |
|                         | 0.82             | MKP386M482250Y**  | 113         | 35                             | 35 | 36 | 40 | 40 | 40 | 35 | 35 |

**Note**

(1) Change the \*\* symbol according special code for the terminals

**CONSTRUCTION**

Low inductive wound cells elements of metallized polypropylene film, potted with resin in flame retardant case. Series construction for 420 V<sub>AC</sub> to 600 V<sub>AC</sub> versions build in case width ≤ 44 mm and 450 V<sub>AC</sub> to 550 V<sub>AC</sub> versions build in case width > 44 mm.

Triple construction for 700 V<sub>AC</sub> and 800 V<sub>AC</sub> versions build in case width ≤ 44 mm and 550 V<sub>AC</sub> to 700 V<sub>AC</sub> versions build in case width > 44 mm.

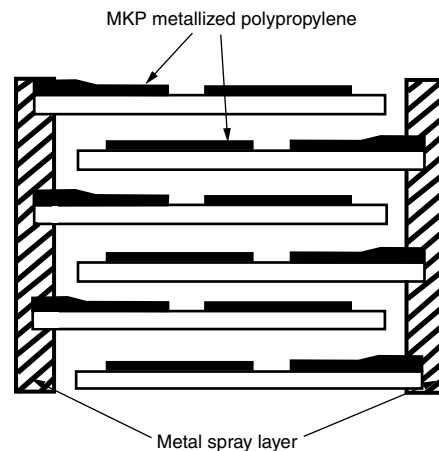
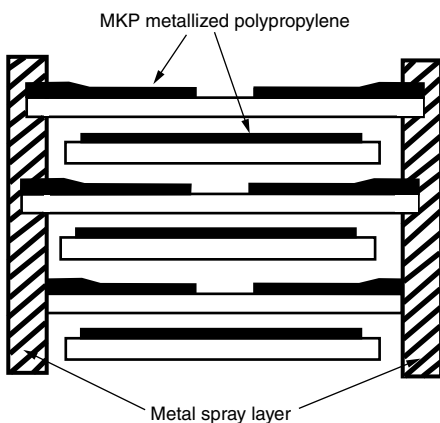

Series construction with 4 sections for 800 V<sub>AC</sub> versions build in case width > 44 mm.





## MOUNTING

### Normal Use

The capacitors are designed for mounting on printed-circuit boards or IGBT or GTO modules.

### Specific Method of Mounting to Withstand Vibration and Shock

In order to withstand vibration and shock tests, the capacitors shall be mechanically fixed by tabs it must be ensured that the tabs are screwed tightly on the test board.

When the weight of the capacitor is bigger than 50 g it needs a clamp in the body of the capacitor.

## SOLDERING CONDITIONS

### Storage Temperature

$T_{stg} = -25\text{ }^{\circ}\text{C}$  to  $+35\text{ }^{\circ}\text{C}$  with RH maximum 75 % without condensation.

### Ratings and Characteristics Reference Conditions

Unless otherwise specified, all electrical values apply to an ambient temperature of  $23\text{ }^{\circ}\text{C} \pm 1\text{ }^{\circ}\text{C}$ , an atmospheric pressure of 86 kPa to 106 kPa and a relative humidity of  $50\% \pm 2\%$ .

For reference testing, a conditioning period shall be applied over  $96\text{ h} \pm 4\text{ h}$  by heating the products in a circulating air oven at the rated temperature and a relative humidity not exceeding 20 %.

## CHARACTERISTICS

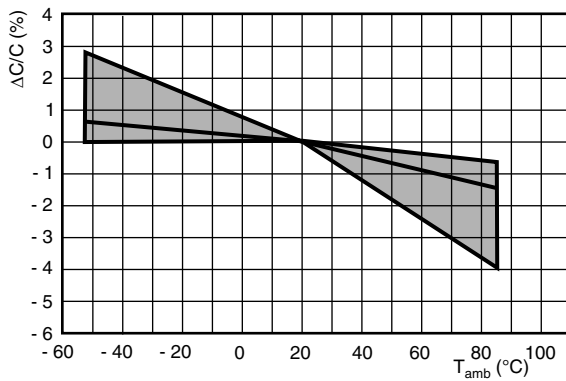

Capacitance as a function of ambient temperature (typical curve)

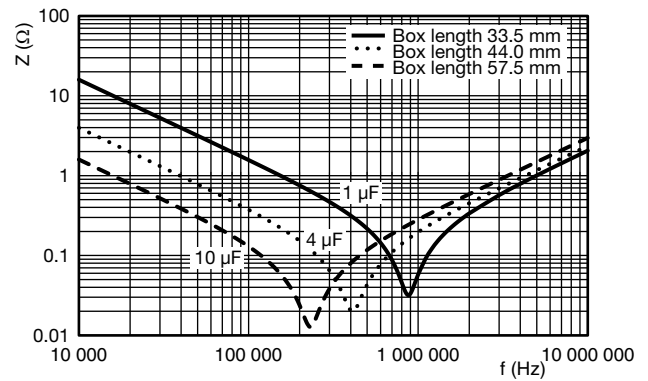

Impedance as a function of frequency (typical curve)



Impedance as function of frequency for box length 44.0 mm (typical curve)

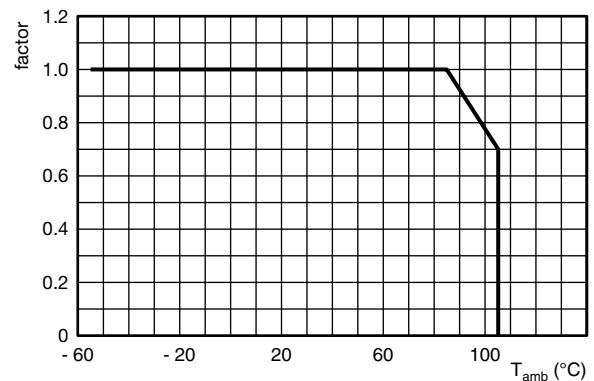

Max. DC and AC voltage as a function of temperature



## CHARACTERISTICS

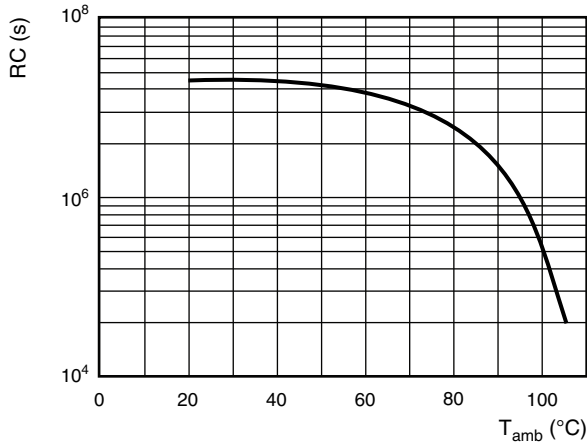

Insulation resistance as a function of ambient temperature (typical curve)

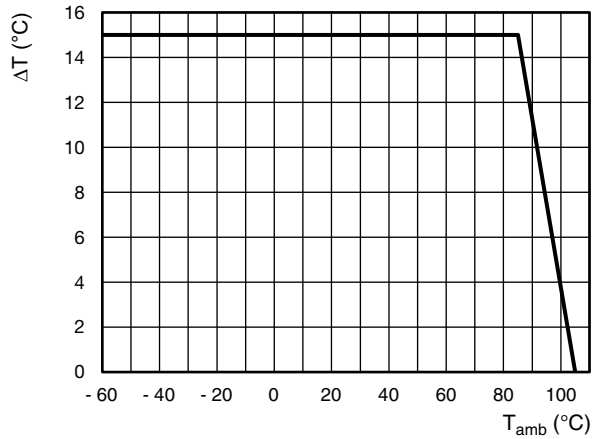

Maximum allowed component temperature rise (ΔT) as function of the ambient temperature (T<sub>amb</sub>)

## MAXIMUM RMS VOLTAGE (SINEWAVE) AS A FUNCTION OF FREQUENCY

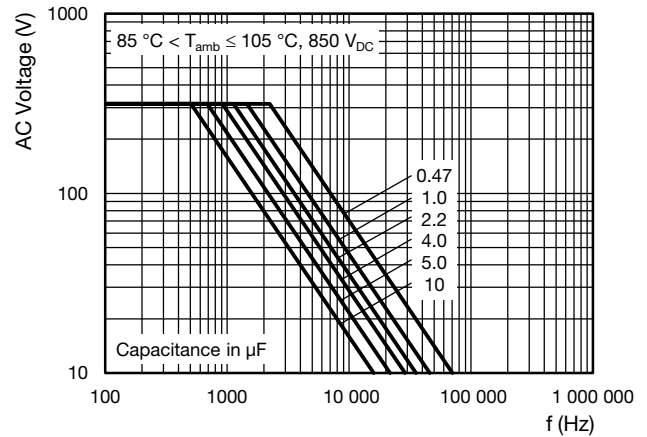
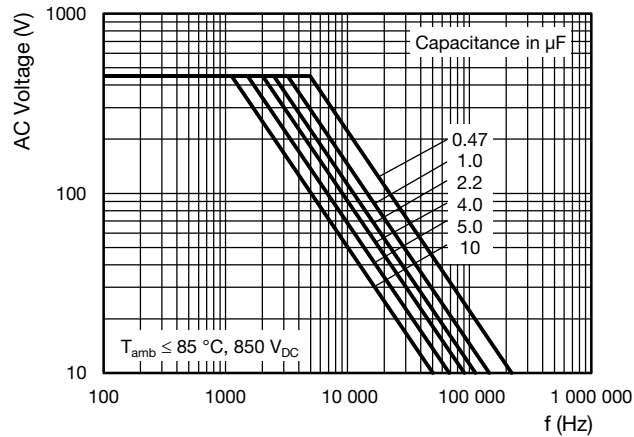
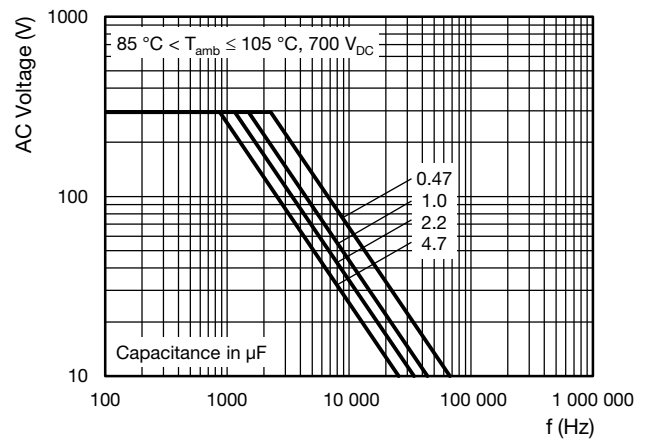



## MAXIMUM RMS VOLTAGE (SINEWAVE) AS A FUNCTION OF FREQUENCY

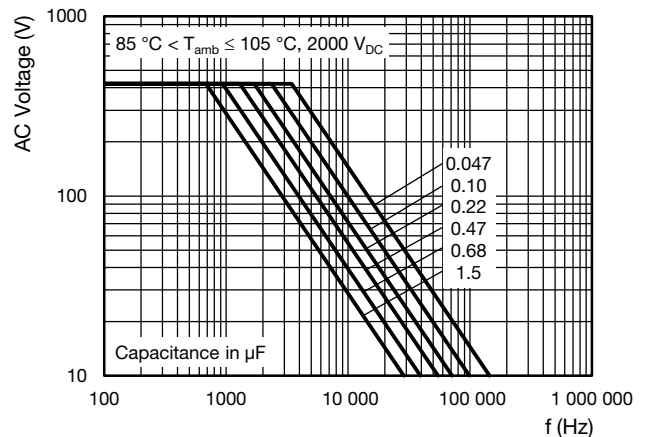
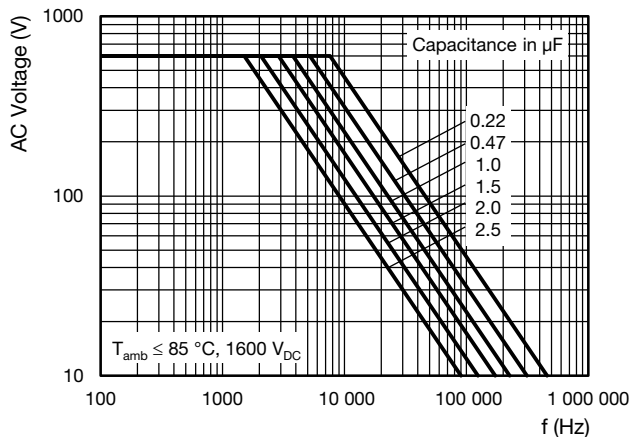
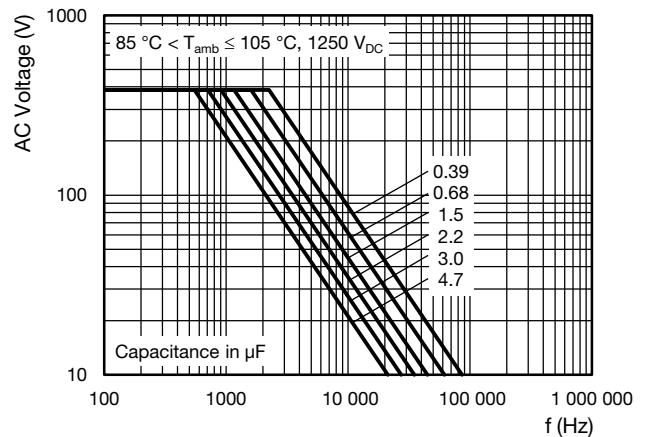
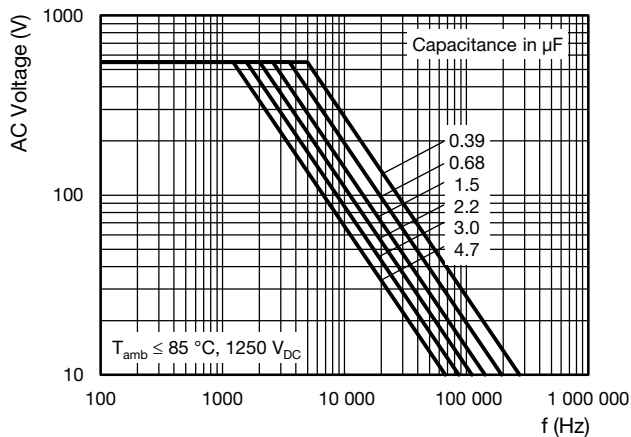
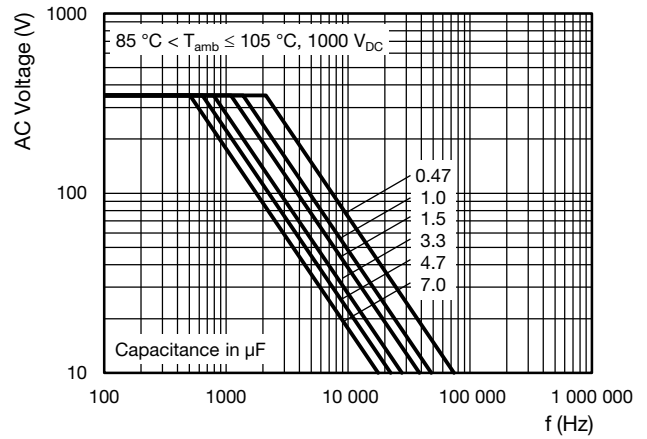



## MAXIMUM RMS VOLTAGE (SINEWAVE) AS A FUNCTION OF FREQUENCY

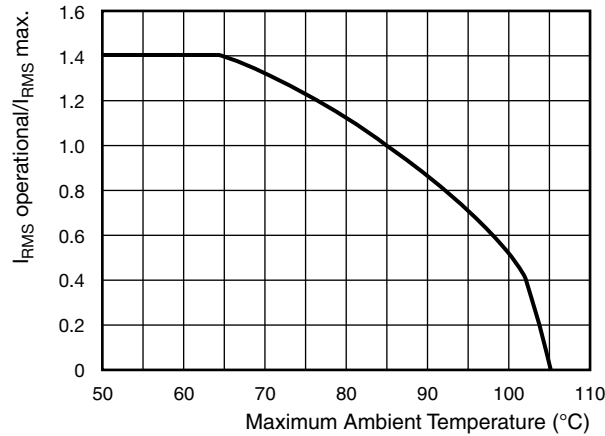
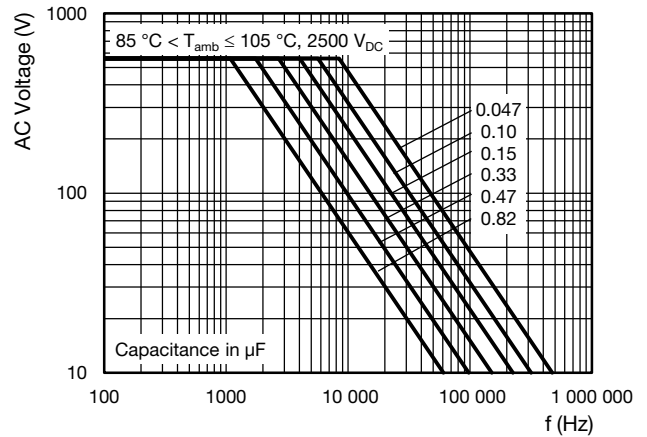
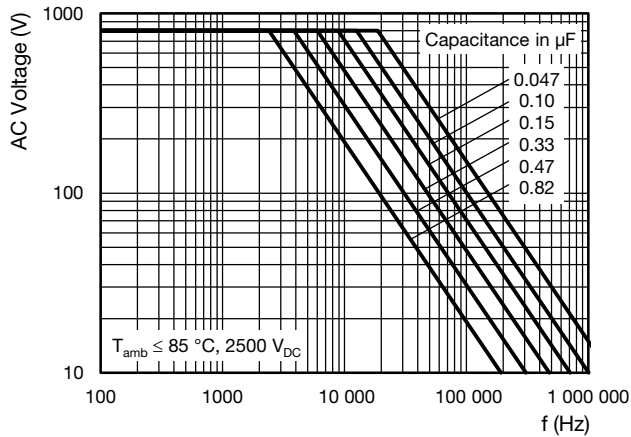

Maximum  $I_{RMS}$  current in function of the ambient temperature



## MARKING

### Product Marking and Identification

The capacitor is marked by laser print or stamp, with following information:

1. Manufacturer's logo
2. Code for dielectric material (MKP)
3. Manufacturer's type designation (386)
4. Single metallized (M)
5. Rated capacitance value (5 µF)
6. Tolerance on rated capacitance (J = ± 5 %)
7. Rated DC voltage (700 V)
8. Code for factory of origin (F)
9. Year and week of manufacture (e.g. 0825)

### Printing Example:



### Packing Bar Code Label

1. Manufacturer's logo
2. Country of origin
3. Sub family
4. Type description
5. Capacitance value, tolerance, voltage and climatic category according to IEC 60068-1
6. Production center
7. Preference origin code: A  
Country of origin in code
8. Product type description
9. Batch number
10. Quantity and production date, year week code
11. Product code

### Label Example:

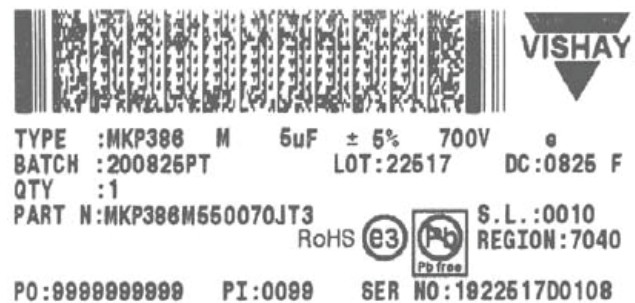

| HEAT CONDUCTIVITY (G) AS A FUNCTION OF ORIGINAL PITCH AND CAPACITOR BODY THICKNESS IN mW/°C |                           |                    |                    |
|---|---------------------------|--------------------|--------------------|
| W <sub>max</sub> . (mm)   | HEAT CONDUCTIVITY (mW/°C) |                    |                    |
|   | BOX LENGTH 33.5 mm        | BOX LENGTH 44.0 mm | BOX LENGTH 58.0 mm |
| 22  | 75                        | 100                | -                  |
| 25  | -                         | -                  | 155                |
| 30  | -                         | 140                | 170                |
| 35  | -                         | -                  | 200                |

## POWER DISSIPATION AND MAXIMUM COMPONENT TEMPERATURE RISE

The power dissipation must be limited in order not to exceed the maximum allowed component temperature rise as a function of the free air ambient temperature.

The power dissipation can be calculated according type detail specification "HQN-384-01/101: Technical Information Film Capacitors" with the typical tgδ of the curves.

The component temperature rise (ΔT) can be measured (see section "Measuring the Component Temperature" for more details) or calculated by  $\Delta T = P/G$ :

- ΔT = Component temperature rise (°C) with maximum of 10 °C rise (°C)
- P = Power dissipation of the component (mW)
- G = Heat conductivity of the component (mW/°C)

**MEASURING THE COMPONENT TEMPERATURE**

A thermocouple must be attached to the capacitor body as in:

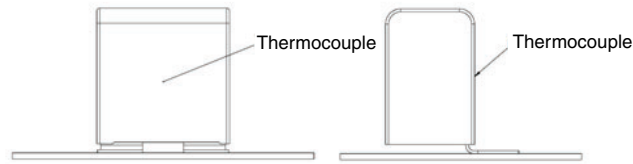

The temperature is measured in unloaded ( $T_{amb}$ ) and maximum loaded condition ( $T_C$ ).

The temperature rise is given by  $\Delta T = T_C - T_{amb}$ .

To avoid radiation or convection, the capacitor should be tested in a wind-free box.

**APPLICATION NOTE AND LIMITING CONDITIONS**

These capacitors are not suitable for mains applications as across-the-line capacitors without additional protection, as described hereunder. These mains applications are strictly regulated in safety standards and therefore electromagnetic interference suppression capacitors conforming the standards must be used.

To select the capacitor for a certain application, the following conditions must be checked:

1. The peak voltage ( $U_p$ ) shall not be greater than the rated DC voltage ( $U_{RDC}$ )
2. The peak-to-peak voltage ( $U_{pp}$ ) shall not be greater than the maximum ( $U_{pp}$ ) to avoid the ionization inception level
3. The voltage peak slope ( $dU/dt$ ) shall not exceed the rated voltage pulse slope in an RC-circuit at rated voltage and without ringing. If the pulse voltage is lower than the rated DC voltage, the rated voltage pulse slope may be multiplied by  $U_{RDC}$  and divided by the applied voltage.

For all other pulses following equation must be fulfilled:

$$2 \times \int_0^T \left( \frac{dU}{dt} \right)^2 \times dt < U_{RDC} \times \left( \frac{dU}{dt} \right)_{rated}$$

T is the pulse duration.

4. The maximum component surface temperature rise must be lower than the limits (see figure Max. Allowed Component Temperature Rise)
5. Since in circuits used at voltages over 280 V peak-to-peak the risk for an intrinsically active flammability after a capacitor breakdown (short circuit) increases, it is recommended that the power to the component is limited to 100 times the values mentioned in the table "Heat conductivity"
6. When using these capacitors as across-the-line capacitor in the input filter for mains applications or as series connected with an impedance to the mains the applicant must guarantee that the following conditions are fulfilled in any case (spikes and surge voltages from the mains included)

| <b>VOLTAGE CONDITIONS FOR 6 ABOVE</b>      |  |  |
|--|--|--|
| <b>ALLOWED VOLTAGES</b>                    | <b><math>T_{amb} \leq 85 \text{ }^\circ\text{C}</math></b> | <b><math>85 \text{ }^\circ\text{C} \leq T_{amb} \leq 105 \text{ }^\circ\text{C}</math></b> |
| Maximum continuous RMS voltage             | $U_{RAC}$  | $0.7 \times U_{RAC}$   |
| Maximum temporary RMS overvoltage (< 24 h) | $1.25 \times U_{RAC}$                                      | $0.875 \times U_{RAC}$   |
| Maximum peak voltage ( $V_{o-p}$ ) (< 2 s) | $1.6 \times U_{RDC}$                                       | $1.1 \times U_{RDC}$   |



**INSPECTION REQUIREMENTS**

**General Notes**

Sub-clause numbers of tests and performance requirements refer to the “Sectional Specification, Publication IEC 60384-17”.

| <b>GROUP C INSPECTION REQUIREMENTS</b>              |   |   |
|---|---|---|
| <b>SUB-CLAUSE NUMBER AND TEST</b>                   | <b>CONDITIONS</b>   | <b>PERFORMANCE REQUIREMENTS</b>   |
| <b>SUB-GROUP C1A PART OF SAMPLE OF SUB-GROUP C1</b> |   |   |
| 4.1 Dimensions (details)                            |   | As specified in chapters “General Data” of this specification                         |
| 4.3.1 Initial measurements                          | Capacitance<br>Tangent of loss angle:<br>For C > 1 µF at 1 kHz<br>For C ≤ 1 µF at 10 kHz  |   |
| 4.3 Robustness of terminations                      | Tensile: Load 30 N; 10 s  | No visible damage   |
| 4.4 Resistance to soldering heat                    | No pre-drying<br>Method: 1A<br>Solder bath: 265 °C<br>Duration: 10 s  |   |
| 4.4.2 Final measurements                            | Visual examination  | No visible damage<br>Legible marking  |
|   | Capacitance   | $ \Delta C/C  \leq 2\%$ of the value measured initially                               |
|   | Tangent of loss angle   | Increase of $\tan \delta: \leq 0.002$<br>Compared to values measured initially        |
|   | Insulation resistance   | $\leq 50\%$ values specified in section “Insulation Resistance” of this specification |
| <b>SUB-GROUP C1B PART OF SAMPLE OF SUB-GROUP C1</b> |   |   |
| 4.6.1 Initial measurements                          | Capacitance<br>Tangent of loss angle:<br>For C > 1 µF at 1 kHz<br>For C ≤ 1 µF at 10 kHz  |   |
| 4.6 Rapid change of temperature                     | $\theta A = -55\text{ °C}$<br>$\theta B = +105\text{ °C}$<br>5 cycles<br>Duration t = 30 min<br>Visual examination  | No visible damage   |
| 4.7 Vibration                                       | Mounting: See section “Mounting” of this specification<br>Procedure B4:<br>Frequency range: 10 Hz to 55 Hz<br>Amplitude: 0.75 mm or<br>Acceleration 98 m/s <sup>2</sup><br>(whichever is less severe)<br>Total duration 6 h |   |
| 4.7.2 Final inspection                              | Visual examination  | No visible damage   |
| 4.9 Shock   | Mounting: See section “Mounting” for more information<br>Pulse shape: Half sine<br>Acceleration: 490 m/s <sup>2</sup><br>Duration of pulse: 11 ms<br>Visual examination   | No visible damage   |



| <b>GROUP C INSPECTION REQUIREMENTS</b>                                     |   |   |
|--|---|---|
| <b>SUB-CLAUSE NUMBER AND TEST</b>  | <b>CONDITIONS</b>   | <b>PERFORMANCE REQUIREMENTS</b>   |
| <b>SUB-GROUP C1B PART OF SAMPLE OF SUB-GROUP C1</b>                        |   |   |
| 4.9.3 Final measurements   | Capacitance<br><br>Tangent of loss angle<br><br>Insulation resistance   | $ \Delta C/C  \leq 2\%$ of the value measured initially<br><br>Increase of $\tan \delta \leq 0.002$<br>Compared to values measured initially<br><br>$\geq 50\%$ values specified in section "Insulation Resistance" of this specification   |
| 4.15 Solvent resistance of the marking                                     | Isopropyl alcohol at room temperature<br>Method: 1<br>Rubbing material: Cotton wool<br>Immersion time: 5 min $\pm$ 0.5 min  | No visible damage<br>Legible marking  |
| <b>SUB-GROUP C1 COMBINED SAMPLE OF SPECIMENS OF SUB-GROUPS C1A AND C1B</b> |   |   |
| 4.10 Climatic sequence   |   |   |
| 4.10.2 Dry heat  | Temperature: + 105 °C<br>Duration: 16 h   |   |
| 4.10.3 Damp heat cyclic<br>Test Db, first cycle                            |   |   |
| 4.10.4 Cold  | Temperature: - 55 °C<br>Duration: 2 h   |   |
| 4.10.6 Damp heat cyclic<br>Test Db<br>remaining cycles                     |   |   |
| 4.10.6.2 Final measurements  | Voltage proof = $U_{RDC}$ for 1 min within<br>15 min after removal from test chamber<br><br>Visual examination<br><br>Capacitance<br><br>Tangent of loss angle<br><br>Insulation resistance | No breakdown or flash-over<br><br>No visible damage<br>Legible marking<br><br>$ \Delta C/C  \leq 3\%$ of the value measured initially<br><br>Increase of $\tan \delta: \leq 0.002$<br>Compared to values measured in 4.3.1 or<br>4.6.1 as applicable<br><br>$\geq 50\%$ of values specified in section<br>"Insulation Resistance" of this specification |
| <b>SUB-GROUP C2</b>  |   |   |
| 4.11 Damp heat steady state  |   |   |
| 4.11.1 Initial measurements  | Capacitance<br>Tangent of loss angle at 1 kHz   |   |
| 4.11.3 Final measurements  | Visual examination<br>Voltage proof = $U_{RDC}$ for 1 min within<br>15 min after removal from test chamber<br><br>Capacitance<br><br>Tangent of loss angle<br><br>Insulation resistance     | No visible damage<br>Legible marking<br>No breakdown or flash-over<br><br>$ \Delta C/C  \leq 3\%$ of the value measured in 4.11.1.<br><br>Increase of $\tan \delta \leq 0.002$<br>Compared to values measured in 4.11.1<br><br>$\geq 50\%$ of values specified in section<br>"Insulation Resistance" of this specification                              |





| <b>GROUP C INSPECTION REQUIREMENTS</b>   |  |  |
|--|--|--|
| <b>SUB-CLAUSE NUMBER AND TEST</b>  | <b>CONDITIONS</b>  | <b>PERFORMANCE REQUIREMENTS</b>  |
| <b>SUB-GROUP C3A</b>   |  |  |
| 4.12.1 Endurance test<br>at 50 Hz alternative voltage                                  | Duration: 2000 h<br>1.25 x U <sub>RAC</sub> at 85 °C<br>0.875 x U <sub>RAC</sub> at 105 °C   |  |
| 4.12.1.1 Initial measurements  | Capacitance<br>Tangent of loss angle at:<br>For C > 1 µF at 1 kHz<br>For C ≤ 1 µF at 10 kHz  |  |
| 4.12.1.3 Final measurements  | Visual examination   | No visible damage<br>Legible marking   |
|  | Capacitance  | ΔC/C  ≤ 5 % compared to values measured in 4.12.1.1  |
|  | Tangent of loss angle  | Increase of tan δ:<br>≤ 0.0015 for C ≤ 1 µF<br>≤ 0.0015 for C > 1 µF<br>Compared to values measured in 4.12.1.1  |
|  | Insulation resistance  | ≥ 50 % of values specified in section "Insulation Resistance" of this specification  |
| <b>SUB-GROUP C4</b>  |  |  |
| 4.2.6 Temperature characteristics<br>Initial measurements<br>Intermediate measurements | Capacitance<br>Capacitance at - 55 °C<br>Capacitance at 20 °C<br>Capacitance at + 105 °C   | For - 55 °C to 20 °C<br>0 % ≤  ΔC/C  ≤ 2.75 % or<br>For 20 °C to 105 °C<br>- 5.5 % ≤  ΔC/C  ≤ 0 %<br>As specified in section "Capacitance" of this specification |
| 4.13 Charge and discharge  | 10 000 cycles<br>(1...50 c/s) 2.5 x (dU/dt) <sub>R</sub> charge to U <sub>RDC</sub><br>with maximum pulse slope ≤ 0.01 (dU/dt) <sub>R</sub><br>Duration: 5 ms<br><br>Discharge resistance:<br>$R = \frac{U_n(V_{DC})}{2.5 \times C (dU/dt)}$ |  |
| 4.13.1 Initial measurements  | Capacitance<br>Tangent of loss angle at:<br>For C > 1 µF at 1 kHz<br>For C ≤ 1 µF at 10 kHz  |  |
| 4.13.3 Final measurements  | Capacitance  | ΔC/C  ≤ 5 % compared to values measured in 4.13.1.   |
|  | Tangent of loss angle  | Increase of tan δ:<br>≤ 0.0015 for C ≤ 1 µF<br>≤ 0.0015 for C > 1 µF<br>Compared to values measured in 4.13.1  |
|  | Insulation resistance  | ≥ 50 % of values specified in section "Insulation Resistance" of this specification  |



## **Disclaimer**

ALL PRODUCT, PRODUCT SPECIFICATIONS AND DATA ARE SUBJECT TO CHANGE WITHOUT NOTICE TO IMPROVE RELIABILITY, FUNCTION OR DESIGN OR OTHERWISE.

Vishay Intertechnology, Inc., its affiliates, agents, and employees, and all persons acting on its or their behalf (collectively, "Vishay"), disclaim any and all liability for any errors, inaccuracies or incompleteness contained in any datasheet or in any other disclosure relating to any product.

Vishay makes no warranty, representation or guarantee regarding the suitability of the products for any particular purpose or the continuing production of any product. To the maximum extent permitted by applicable law, Vishay disclaims (i) any and all liability arising out of the application or use of any product, (ii) any and all liability, including without limitation special, consequential or incidental damages, and (iii) any and all implied warranties, including warranties of fitness for particular purpose, non-infringement and merchantability.

Statements regarding the suitability of products for certain types of applications are based on Vishay's knowledge of typical requirements that are often placed on Vishay products in generic applications. Such statements are not binding statements about the suitability of products for a particular application. It is the customer's responsibility to validate that a particular product with the properties described in the product specification is suitable for use in a particular application. Parameters provided in datasheets and / or specifications may vary in different applications and performance may vary over time. All operating parameters, including typical parameters, must be validated for each customer application by the customer's technical experts. Product specifications do not expand or otherwise modify Vishay's terms and conditions of purchase, including but not limited to the warranty expressed therein.

Except as expressly indicated in writing, Vishay products are not designed for use in medical, life-saving, or life-sustaining applications or for any other application in which the failure of the Vishay product could result in personal injury or death. Customers using or selling Vishay products not expressly indicated for use in such applications do so at their own risk. Please contact authorized Vishay personnel to obtain written terms and conditions regarding products designed for such applications.

No license, express or implied, by estoppel or otherwise, to any intellectual property rights is granted by this document or by any conduct of Vishay. Product names and markings noted herein may be trademarks of their respective owners.

# Mouser Electronics

Authorized Distributor

Click to View Pricing, Inventory, Delivery & Lifecycle Information:

## Vishay:

[MKP386M422200JT4](#) [MKP386M447125JT5](#) [MKP386M410200JT5](#) [MKP386M520125JT4](#) [MKP386M510125JT4](#)  
[MKP386M510200YT4](#) [MKP386M550125YT4](#) [MKP386M447200JT4](#) [MKP386M515200YT4](#) [MKP386M530125YT4](#)  
[MKP386M418250JT1](#) [MKP386M533085JT4](#) [MKP386M510085JT7](#) [MKP386M512125JT4](#) [MKP386M533100JT4](#)  
[MKP386M520085JT1](#) [MKP386M456100JT7](#) [MKP386M510160JT1](#) [MKP386M510085JT5](#) [MKP386M520085JT4](#)  
[MKP386M347250JT7](#) [MKP386M447085JT7](#) [MKP386M468125JT7](#) [MKP386M533100JT1](#) [MKP386M522125JT1](#)  
[MKP386M520100JT4](#) [MKP386M447250JT4](#) [MKP386M433125JT7](#) [MKP386M418250JT4](#) [MKP386M347250JT5](#)  
[MKP386M447250JT1](#) [MKP386M456160JT4](#) [MKP386M410200JT7](#) [MKP386M422160JT7](#) [MKP386M520100JT1](#)  
[MKP386M456160JT1](#) [MKP386M447085JT5](#) [MKP386M522125JT4](#) [MKP386M510100JT5](#) [MKP386M433125JT5](#)  
[MKP386M422160JT5](#) [MKP386M510100JT7](#) [MKP386M468125JT5](#) [MKP386M456100JT5](#) [MKP386M512125JT1](#)  
[MKP386M510160JT4](#) [MKP386M533085JT1](#) [MKP386M522085JT4](#) [MKP386M468100JT5](#) [MKP386M433160JT5](#)  
[MKP386M415250JT4](#) [MKP386M433250JT4](#) [MKP386M447160JT5](#) [MKP386M347200JT5](#) [MKP386M439250JT4](#)  
[MKP386M550100YT4](#) [MKP386M610085YT4](#)