

Quietshield™ Gaskets & Shielding

flexible, conformable and lightweight Quietshield™ products deliver effective EMI shielding across seams or gaps within an enclosure

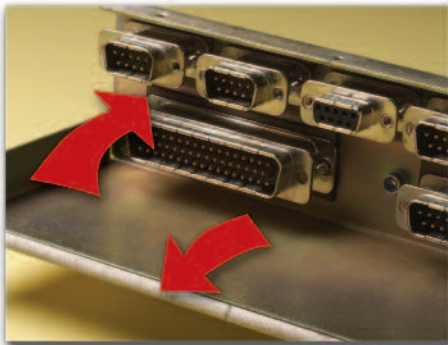

Fabric-Over-Foam Gaskets are low cost, soft and easy to apply. These gaskets are available in a variety of materials and profiles, including rectangular, "D" shaped, FL shaped and DD shaped... **FC68-FC69**

Waved Metal and Fabric-Over-Foam I/O Gaskets are flat products used to provide a ground contact between a metal connector and the electronic enclosure or mating connector... **FC70**

Shielding Tapes and Fabrics are flexible, lightweight, and easy-to-install shielding materials offering high conductivity with a low electrical resistance and are available in a variety of fabric styles... **FC71**

Wire Mesh Gaskets are available as all mesh or elastomer core mesh gaskets. They provide excellent heat and corrosion resistance and are used between two surfaces to maintain electrical continuity while shielding electromagnetic waves... **FC72**

Conductive Silicone is used for its heat resistant properties and can be produced in many different forms such as sheets, molded parts, die-cuts or strips. These conductive elastomers are water resistant, can eliminate static electricity, and act as an absorber at high frequencies... **FC73**

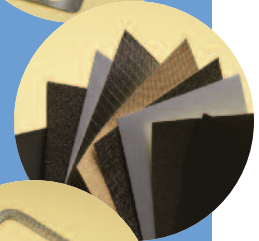
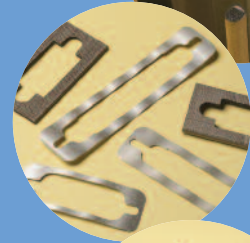

Shielding Theory and Introduction

Shielding Theory

Electromagnetic shielding is used to prevent electromagnetic signals such as radio signals from leaving or entering a box or enclosure. Signals inadvertently emitted by an electronic device can cause distortion or interruption in normal radio communications in a localized area. This is the basis of most laws and regulations concerning electromagnetic interference. In addition, normal radio signals can cause unprotected electronic devices to malfunction. Depending on the device's function, a malfunction in the device could be a minor inconvenience such as static on a radio, or life threatening such as the malfunction of a life support system at a hospital.

Introduction

The electromagnetic shield in most cases is the electronic housing itself. The housing/shield forms a metal cage around the electronic circuits in a device. Most of the electromagnetic signal is absorbed with a small portion (3 to 10 dB) of the signal reflected off the metal housing. Most of the absorbed signal creates alternating currents at radio frequencies which travels on the surface of metal. This allows the electromagnetic shield to keep signals from outside the enclosure on the outside of the shield and signals from inside signals on the inside of the shield.

The shield will continue to function as long as there are no holes in the electromagnetic shield which would allow the currents to flow from one side of the shield to the other. Holes are a necessity in an electronic enclosure. Connectors, wires, and cables are needed to transmit information to and from electronic devices. Doors and covers are needed to get access to components to maintenance, service, and keypads may also be required. The problem is that all of these items cause openings in the shield which reduce the performance of the shield.

Special devices such as shielding gaskets, shielding ventilation panels, shielded filtered connectors, and shielded switches minimize the effect of a hole in the shield.

The length of the hole and wavelength of the signal that needs to be shielded are the major factors determining the shielding effectiveness of an electronic enclosure. The distance between spotwelds, or screws which hold a metal housing together count as long narrow holes. Higher frequencies (lower wavelengths) flow more easily through smaller holes, and so the highest frequency needed to be shielded is the frequency of concern when designing shielding.

Aperture versus frequency charts can give a rough estimate of the shielding effectiveness of a metallic electronic housing.

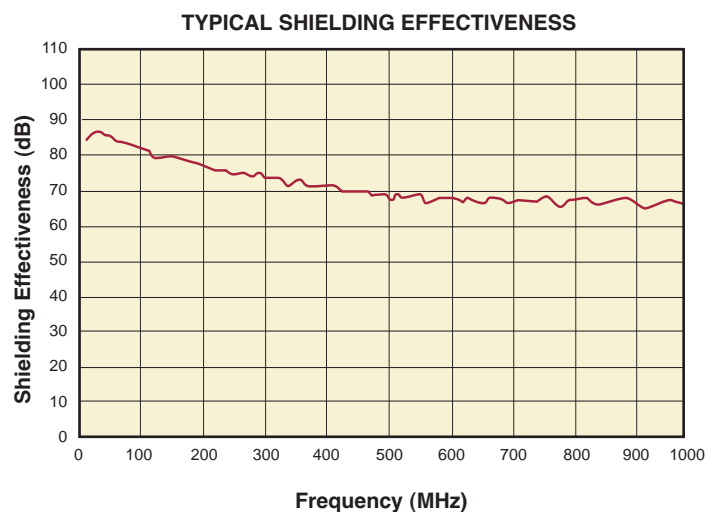
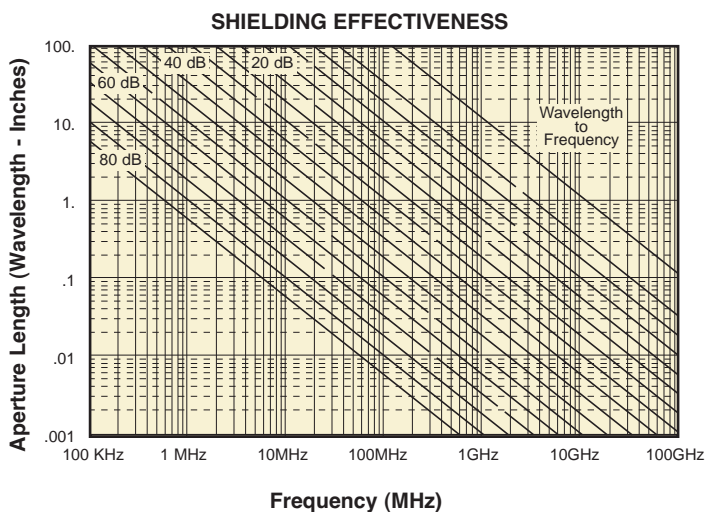

Test Methods: ASTM D-4935-89
Test Fixture: Flanged coaxial transmission line

Quietshield™ Part Number System

Example: **57D1211205 - 7200**

The part number shown represents a gasket with woven foam made of neoprene, conductive PSA.
The gasket has copper-nickel plating that is 0.120" wide x 0.050" thick x 72" long.

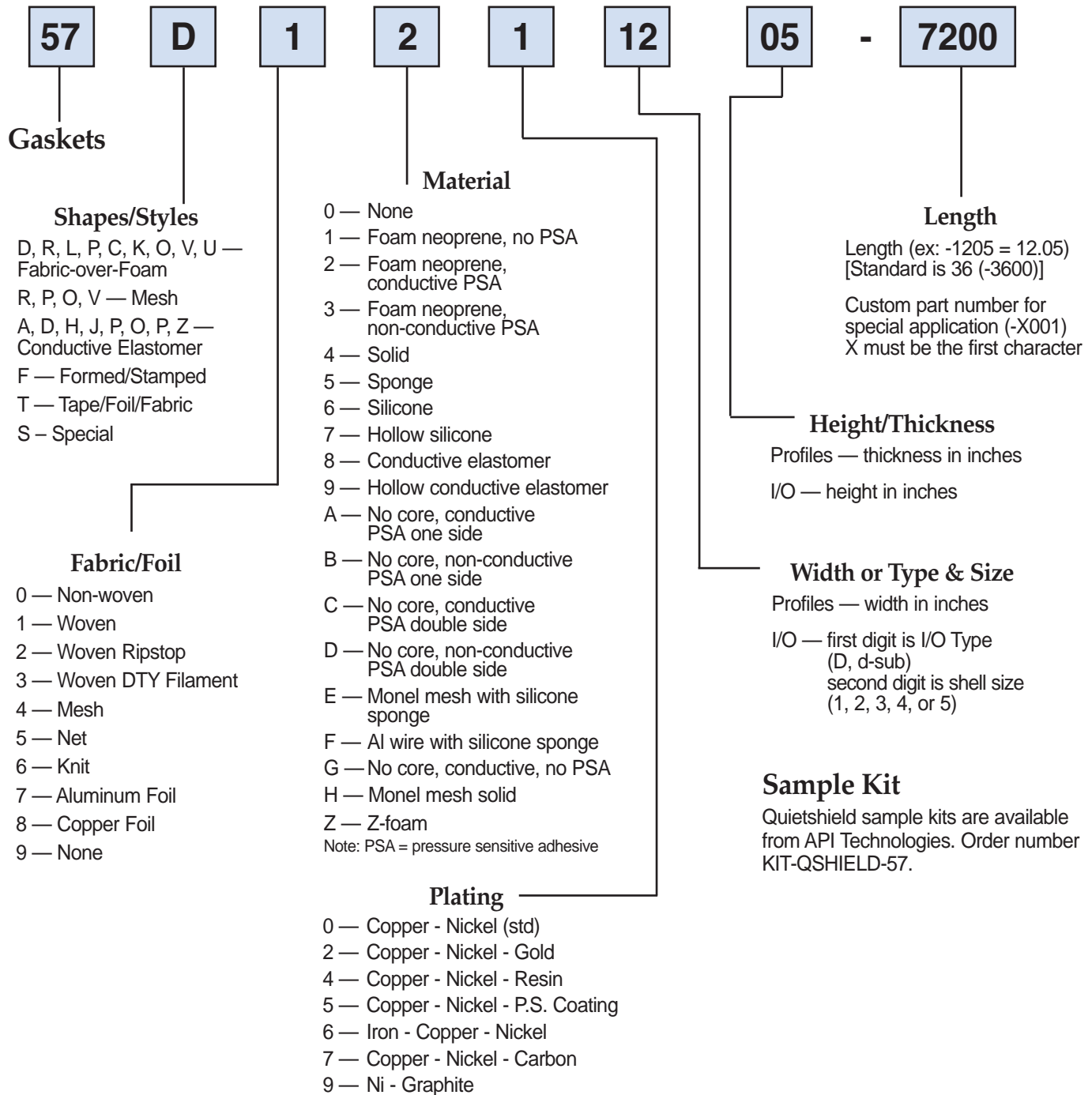

Quietshield™ Fabric-over-Foam Gaskets

Features

- Maintain shielding effectiveness across seams or gaps
- Shielding Effectiveness (SE) of 70 - 100 dB between 1 MHz to 18 GHz
- Flexible and conformable
- No creasing or tearing
- Lightweight material

Profile Gaskets

Quietshield™ EMI/RFI Gaskets maintain shielding effectiveness (SE) across a seam or gap in the electronic equipment's shielding material.

Quietshield gaskets provide unique solutions to your most stringent shielding, grounding, ESD and packaging requirements. It's the cost-effective avenue for creativity in design. These gaskets consist of polyurethane foam combined with highly conductive fabrics. Specially designed polyurethane foam is soft, resilient and provides the perfect fit. Our gaskets are made with seven different types of fabric plating and two types of thermal adhesive, standard or flame retardant. Our flame retardant adhesive complies with UL94VTM-1 and VTM-0. If necessary, the polyurethane foam core can also be plated with Cu and Ni to provide additional conductivity.

Fabric-over-Foam Gaskets, unlike elastomer or finger strip gaskets, provide softness for easy application with a variety of materials and designs at low cost. The best quality with high conductivity, low electrical resistance and minimum oxidation can be achieved by using gold gaskets with additional gold plating to provide superior shielding.

Profile gaskets are currently available in a variety of shapes and lengths. API's Spectrum Control line of gaskets provide a variety of applications with lightweight and flexible solutions. Various thicknesses and shapes are available. These range from commonly used ones such as rectangular and "D" shape, to uncommon ones such as FL-shape (folding leaf) and DD-shape (Double DD-shape). We are able to produce gaskets with different shapes and sizes, based upon the customer's requests.

The mounting style available for most profile gaskets is pressure sensitive adhesive. These adhesives allow simple place and press mounting on smooth and clean metal surfaces. The parts can be cut to the desired length with common scissors or ordered to the exact length required. The adhesive provides high strength with aggressive initial tack, which increases in strength over time or after exposure to elevated temperatures.



I/O Gaskets

API offers a complete line of standard and custom I/O connector Electromagnetic Shielding Gaskets. I/O gaskets are flat gaskets used to provide a ground contact between a metal connector and the electronic enclosure or mating connector. They ensure that the shield remains continuous from the input/output cable to the electronic enclosure.

I/O Gaskets are available in the same materials as the fabric-over-foam profile gaskets, or as all-metal waved gaskets.

API's line of metal waved gaskets is designed to minimize the gaps between a D-Sub connector and the panel it is mounted to. These gaskets ensure the maximum "gap length" will not exceed the wave pitch, 0.200" (5.08 MM), even on surfaces with poor flatness. This ensures maximum filter performance to 1GHz and beyond.

Test	Performance
Shielding Effectiveness*	68 dB - 88 dB
Composition (STD)	Woven
Plating (STD)	Copper and Nickel
Temperature Limit	200°C
Abrasion Resistance	Good
Electric Resistance	<0.08 Ohm
Flamability Rating**	94VTM-1, V0 Grade
Shelf Life***	20 years

* Provides shielding effectiveness of 68 dB min. between 30 MHz to 1 GHz, this will vary slightly depending on fabric type.

** Rubber rating only.

*** Fabric-over-foam gaskets.

Quietshield™ Fabric-over-Foam Profile Gaskets

Rectangular Type "R"

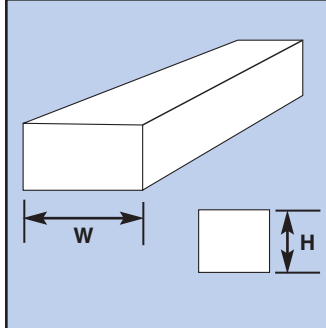

W	H	Part Number
1.000	0.374	57R121C037-xxxx
0.118	0.079	57R1211208-xxxx
0.154	0.118	57R1211512-xxxx
0.158	0.079	57R1211608-xxxx
0.158	0.158	57R1211616-xxxx
0.130	0.189	57R1211913-xxxx
0.197	0.197	57R1212020-xxxx
0.252	0.126	57R1212512-xxxx
0.315	0.472	57R1213247-xxxx
0.374	0.126	57R1213713-xxxx
0.374	0.374	57R1213737-xxxx
0.394	0.394	57R1213939-xxxx
0.102	0.400	57R1214012-xxxx
0.394	0.236	57R1214022-xxxx
0.488	0.370	57R1214937-xxxx
0.500	0.126	57R1215013-xxxx
0.252	0.500	57R1215025-xxxx
0.500	0.500	57R1215050-xxxx
0.512	0.118	57R1215112-xxxx
0.512	0.394	57R1215140-xxxx
0.984	0.394	57R1219839-xxxx

C-Fold Type "C"

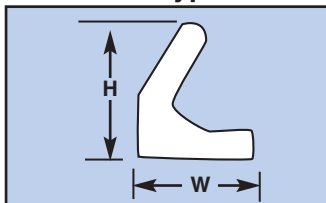

W	H	Part Number
0.295	0.138	57L1213014-xxxx
0.315	0.315	57L1213232-xxxx
0.394	0.394	57L1213939-xxxx
0.421	0.386	57L1214339-xxxx
0.681	0.591	57L1216859-xxxx

Flat Type "R"

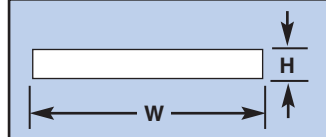

W	H	Part Number
0.118	0.039	57R1211204-xxxx
0.158	0.031	57R1211603-xxxx
0.158	0.035	57R1211604-xxxx
0.158	0.039	57R1211604-xxxx
0.158	0.047	57R1211605-xxxx
0.197	0.020	57R1212002-xxxx
0.197	0.039	57R1212004-xxxx
0.197	0.047	57R1212005-xxxx
0.197	0.059	57R1212006-xxxx
0.197	0.071	57R1212007-xxxx
0.236	0.039	57R1212404-xxxx
0.236	0.059	57R1212406-xxxx
0.276	0.020	57R1212802-xxxx
0.276	0.039	57R1212804-xxxx
0.276	0.047	57R1212805-xxxx
0.276	0.059	57R1212806-xxxx
0.276	0.071	57R1212807-xxxx
0.299	0.063	57R1213006-xxxx
0.315	0.031	57R1213203-xxxx
0.315	0.039	57R1213204-xxxx
0.354	0.039	57R1213604-xxxx
0.394	0.020	57R1214002-xxxx
0.394	0.039	57R1214004-xxxx
0.394	0.047	57R1214005-xxxx
0.394	0.071	57R1214007-xxxx
0.472	0.039	57R1214704-xxxx
0.472	0.059	57R1214706-xxxx
0.512	0.028	57R1215103-xxxx
0.512	0.035	57R1215104-xxxx
0.512	0.059	57R1215106-xxxx
0.551	0.059	57R1215506-xxxx

P-Shape Type "P"

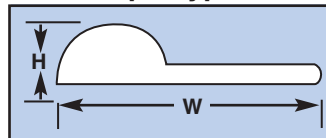

W	H	Part Number
0.315	0.079	57P1213208-xxxx
0.520	0.130	57P1215216-xxxx

L-Shape Type "L"

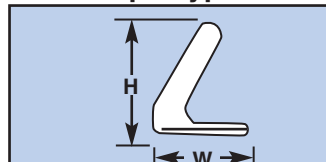

W	H	Part Number
0.430	0.395	57L1214339-7200
0.433	0.433	57L1214343-7200
0.551	0.591	57L1215559-7200
0.578	0.673	57L1215767-7200

Knife Edge Type "K"

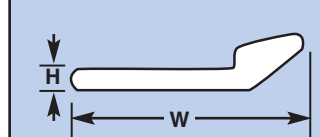

W	H	Part Number
0.492	0.138	57K1214914-xxxx
0.500	0.094	57K1215009-xxxx
0.500	0.098	57K1215010-xxxx
0.752	0.252	57K1217525-xxxx

Double D-Shape "V"

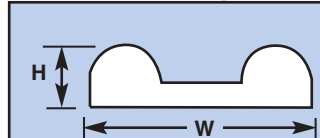

W	H	Part Number
0.378	0.126	57V1213813-xxxx

Folding Leaf Type "U"

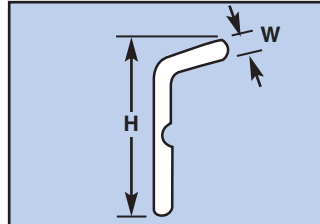

W	H	Part Number
0.709	0.311	57U1217131-xxxx

Round Type "O"

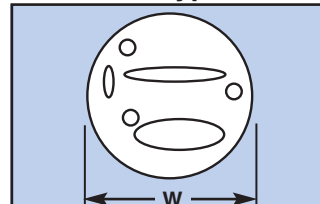

W	Part Number
0.098	57O1211010-xxxx
0.106	57O1211111-xxxx
0.126	57O1211313-xxxx
0.177	57O1211818-xxxx
0.197	57O1212020-xxxx
0.347	57O1213535-xxxx
0.394	57O1213939-xxxx
0.433	57O1214343-xxxx

D-Shape "D"

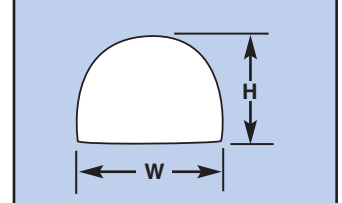

W	H	Part Number
0.090	0.091	57D1210909-xxxx
0.091	0.126	57D1210912-xxxx
0.102	0.126	57D1211012-xxxx
0.118	0.079	57D1211208-xxxx
0.118	0.138	57D1211214-xxxx
0.150	0.059	57D1211506-xxxx
0.150	0.118	57D1211512-xxxx
0.158	0.157	57D1211616-xxxx
0.197	0.197	57D1212020-xxxx
0.236	0.079	57D1212408-xxxx
0.236	0.177	57D1212418-xxxx
0.236	0.197	57D1212420-xxxx
0.236	0.217	57D1212422-xxxx
0.252	0.118	57D1212512-xxxx
0.256	0.134	57D1212514-xxxx
0.256	0.197	57D1212520-xxxx
0.315	0.394	57D1213240-xxxx
0.354	0.118	57D1213512-xxxx
0.354	0.126	57D1213513-xxxx
0.374	0.236	57D1213725-xxxx
0.386	0.252	57D1213925-xxxx
0.394	0.157	57D1213916-xxxx
0.394	0.177	57D1213918-xxxx
0.394	0.197	57D1213920-xxxx
0.394	0.217	57D1213922-xxxx
0.394	0.236	57D1213924-xxxx
0.394	0.276	57D1213928-xxxx
0.394	0.295	57D1213930-xxxx
0.394	0.394	57D1213939-xxxx
0.433	0.138	57D1214314-xxxx
0.433	0.177	57D1214318-xxxx
0.433	0.217	57D1214322-xxxx
0.709	0.551	57D1217155-xxxx
0.709	0.787	57D1217177-xxxx
0.709	0.906	57D1217191-xxxx

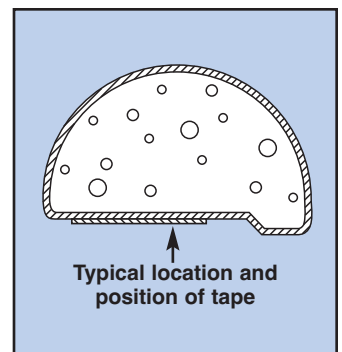

NOTE: All dimensions in inches

Quietshield™ Fabric-over-Foam I/O & Waved Metal Gaskets

Specifications

Material Beryllium Copper, CA 172
(per QQ-C-533)

Finish STD: Electro tin plate, 100 micro inches (per MIL-T-10727)

For RoHS: Nickel - change last 2 p/n digits to - NI
For Hi-Rel: Gold - change last 2 p/n digits to - AU

Material Thickness005" (.13mm) compressed

Wave Height030" +.020/- .015
(.76+.51/- .38mm)

Length increase when flattened 0.008" (.20mm) per inch

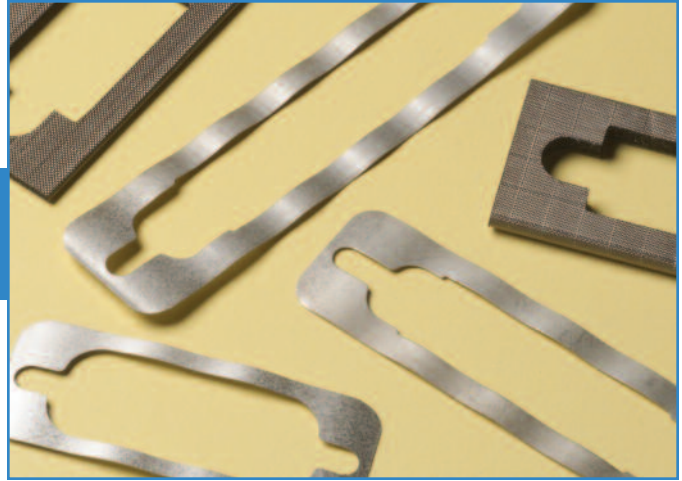

Waved Metal Grounding/Shielding Gasket (shown in free state)

Wave Height



Waved Metal Gaskets (Select part number by filling in "xxx": 572019-00xxx-70)

Mounting: Front mounted pin or socket connector, rear mounted pin connector.						
Shell Size	A ±.020 (0.51)	B ±.020 (0.51)	C ±.020 (0.51)	D ±.020 (0.51)	E ±.005 (0.13)	"xxx"
9	1.213 (30.81)	.984 (24.99)	.777 (19.74)	.600 (15.24)	.440 (11.18)	100
15	1.541 (39.14)	1.312 (33.32)	1.105 (28.07)	.600 (15.24)	.440 (11.18)	101
25	2.088 (53.04)	1.852 (47.04)	1.645 (41.78)	.600 (15.24)	.440 (11.18)	102
37	2.729 (69.32)	2.500 (63.50)	2.293 (58.24)	.600 (15.24)	.440 (11.18)	103
50	2.635 (66.93)	2.406 (61.11)	2.190 (55.63)	.710 (18.03)	.550 (13.97)	104

Mounting: Rear mounted socket connectors only.								
Shell Size	A ±.020 (0.51)	B ±.020 (0.51)	C ±.020 (0.51)	D ±.020 (0.51)	E ±.005 (0.13)	F ±.005 (0.13)	G ±.020 (0.51)	"xxx"
9	1.213 (30.81)	.984 (24.99)	.450 (11.43)	.660 (16.76)	.324 (8.23)	.360 (9.14)	.600 (15.24)	105
15	1.541 (39.14)	1.312 (33.32)	.670 (17.02)	.988 (25.10)	.324 (8.23)	.360 (9.14)	.600 (15.24)	106
25	2.088 (53.04)	1.852 (47.04)	1.110 (28.19)	1.528 (38.81)	.324 (8.23)	.360 (9.14)	.600 (15.24)	107
37	2.729 (69.32)	2.500 (63.50)	1.550 (39.37)	2.176 (55.27)	.324 (8.23)	.360 (9.14)	.600 (15.24)	108
50	2.635 (66.93)	2.406 (61.11)	1.550 (39.37)	2.082 (52.88)	.436 (11.07)	.470 (11.94)	.710 (18.03)	109

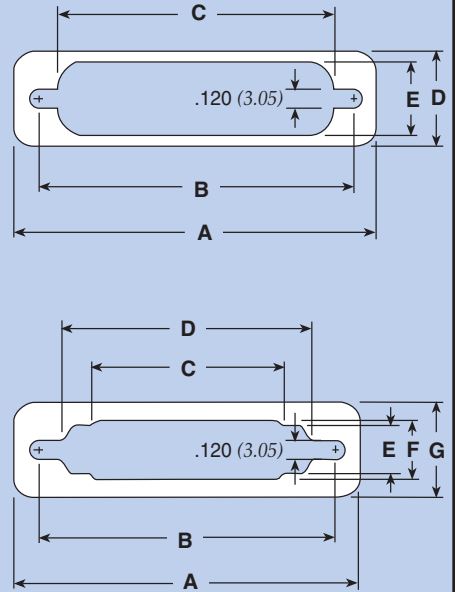

Fabric-over-Foam I/O Gaskets

Shell Size	Thickness	Dimensions						Fabric Type	Part Number		
		A	B	C	D	E	F				
1	0.012							nonwoven	57F01-D112-1275		
	0.040	0.746 (18.95)	1.213 (30.81)	0.984 (24.99)	0.400 (10.16)	0.750 (19.05)				woven	57F11-D140-1275
	0.070										
2	0.012							nonwoven	57F01-D212-1575		
	0.040	1.074 (27.28)	1.541 (39.14)	1.312 (33.32)	0.400 (10.16)	0.750 (19.05)				woven	57F11-D240-1575
	0.070										
3	0.012							nonwoven	57F01-D312-2075		
	0.040	1.614 (41.00)	2.088 (53.04)	1.852 (47.04)	0.400 (10.16)	0.750 (19.05)				woven	57F11-D340-2075
	0.070										
4	0.012							nonwoven	57F01-D412-2775		
	0.040	2.266 (57.56)	2.720 (69.09)	2.500 (63.50)	0.400 (10.16)	0.750 (19.05)				woven	57F11-D440-2775
	0.070										
5	0.012							nonwoven	57F01-D512-2685		
	0.040	2.158 (54.81)	2.63 (66.80)	2.406 (61.11)	0.500 (12.70)	0.850 (21.59)				woven	57F11-D540-2685
	0.070										

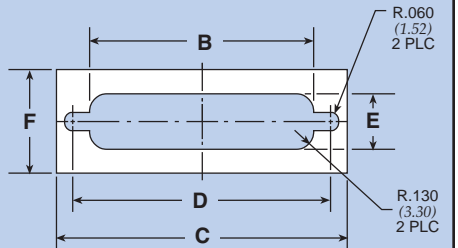

Dimensions in inches (mm)

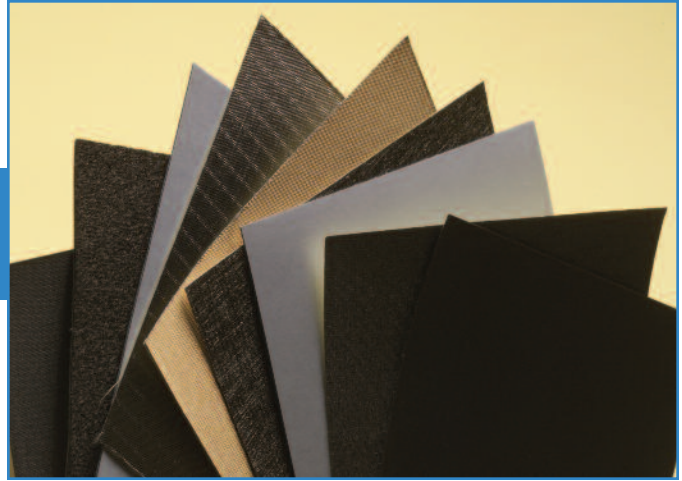

Shielding Tapes & Fabric

Flexible and lightweight tapes provide easy installation and high conductivity and low electrical resistance provide a good shielding effect. Our products use stronger pressure sensitive adhesive to provide better adhesion. Standard widths are 1", 2", 3" and 42". Standard roll lengths are 200'.

API Technologies' Spectrum Control brand of conductive tapes consist of conductive fabric and adhesive which can be either conductive or non-conductive. Conductive tapes come in various types: conductive fabric tapes, Cu/Al foil tapes and double side conductive adhesive tapes. Anticorrosion coating is done on foil tapes and flame retardant coating is available, which complies with UL94VTM-1 and VTM-0.

Styles

- Nonwoven polyester taffeta
- Conductive woven polyester taffeta
- Woven ripstop
- Woven DTY filament
- Mesh
- Aluminum foil
- Copper foil

Material	Plating	Weight (lb/sf)	Weight (g/sm)	Thickness (mm)	Tensile Strength (Kgf)	Surface Resistance (ohm/sq)	Shielding Effectiveness (min dB)	Part Number
Conductive Woven	Cu/Ni	0.015566	76.0	0.08	38.0	0.20	58	57T1A14200-XXXX
Conductive Woven	Cu/Ni/Au	0.005325	26.0	0.10	29.0	0.06	72	57T1A24200-XXXX
Conductive Woven	Cu/Ni/Fe	0.016385	80.0	0.10	32.0	0.06	63	57T1A64200-XXXX
Conductive Woven	Cu/Ni/Ag	0.015975	78.0	0.10	32.0	0.06	67	57T1A34200-XXXX
Conductive Woven	Cu/Ni/Resin	0.016385	80.0	0.11	32.0	0.06	78	57T1A44200-XXXX
Conductive Rip-Stop	Cu/Ni	0.014951	73.0	0.09	39.0	0.08	62	57T2A14200-XXXX
Conductive Rip-Stop	Cu/Ni/Ag	0.015566	76.0	0.10	34.0	0.06	78	57T2A34200-XXXX
Conductive Rip-Stop	Cu/Ni/Fe	0.014951	73.0	0.09	33.0	0.06	63	57T2A64200-XXXX
Conductive Rip-Stop	Cu/Ni/Resin	0.014951	73.0	0.09	34.0	0.06	68	57T2A44200-XXXX
Conductive Non-Woven	Cu/Ni	0.013927	68.0	0.16	10.0	0.08	72	57T0A14206-XXXX
Conductive Non-Woven	Cu/Ni	0.024372	119.0	0.32	21.0	0.06	80	57T0A14201-XXXX
Conductive Non-Woven	Cu/Ni	0.024577	120.0	0.43	30.0	0.06	83	57T0A14202-XXXX
Conductive Mesh	Cu/Ni	0.005120	25.0	0.08	18.0	0.20	52	57T4014200-XXXX
Conductive Mesh	Cu/Ni/Resin	0.005523	27.0	0.08	19.0	0.10	53	57T4044200-XXXX
Conductive Mesh	Cu/Ni/Au	0.003072	15.0	0.08	17.0	0.10	57	57T4034200-XXXX
Aluminum				0.08		0.05		57T7A-4200-XXXX
Aluminum				0.08		0.07		57T7C-4200-XXXX
Copper				0.80		0.02		57T8A-4200-XXXX

Wire Mesh Gaskets

API's Spectrum Control brand mesh gaskets include all mesh gaskets and elastomer core mesh gaskets.

Layers of knitted wire are covered over the wire core in API's all mesh gaskets. Using its electrical conductivity, they are used between two surfaces to maintain electrical continuity while shielding electromagnetic waves. They offer good resilience and excellent heat and corrosion resistance. Any types of metal can be used to produce mesh gaskets but common materials used are aluminum, stainless steel and monel.



API's elastomer core mesh gaskets are composed of wire mesh over elastomer core. Both these materials provide excellent shielding effects creating the maximum outcome. Both all-mesh gaskets and Elastomer-core mesh gaskets can be produced with different types of materials and also in many different forms.

All Mesh Gaskets - Structure

Rectangular Type "R"

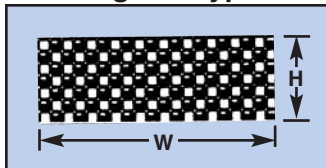

W	H	Part Number
0.138	0.059	57R40-1406-xxxx
0.142	0.098	57R40-1410-xxxx
0.181	0.102	57R40-1810-xxxx
0.197	0.118	57R40-2012-xxxx
0.189	0.189	57R40-2020-xxxx
0.236	0.118	57R40-2412-xxxx
0.252	0.063	57R40-2506-xxxx
0.256	0.177	57R40-2618-xxxx
0.354	0.118	57R40-3512-xxxx

P-Type "P"

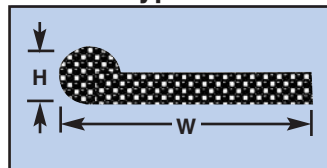

W	H	Part Number
0.138	0.512	57P40-1451-xxxx
0.138	0.638	57P40-1464-xxxx
0.138	0.795	57P40-1478-xxxx
0.205	0.516	57P40-2152-xxxx
0.205	0.768	57P40-2177-xxxx
0.264	0.764	57P40-2626-xxxx

Double P-Type "V"

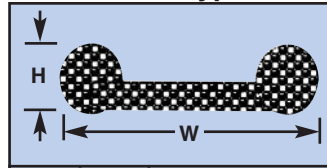

W	H	Part Number
0.138	0.386	57V40-1439-xxxx
0.138	0.512	57V40-1451-xxxx
0.138	0.638	57V40-1464-xxxx
0.205	0.642	57V40-2164-xxxx
0.205	0.768	57V40-2177-xxxx
0.205	1.016	57V40-2100-xxxx
0.264	0.638	57V40-2669-xxxx
0.264	0.764	57V40-2676-xxxx
0.264	1.012	57V40-2600-xxxx

Round Type "O"

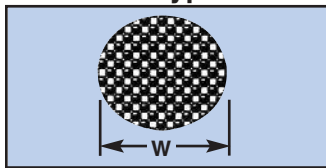

W	Part Number
0.039	57O40-0404-xxxx
0.059	57O40-0606-xxxx
0.079	57O40-0808-xxxx
0.102	57O40-1010-xxxx
0.138	57O40-1414-xxxx
0.157	57O40-1616-xxxx
0.185	57O40-1919-xxxx
0.217	57O40-2222-xxxx
0.307	57O40-3131-xxxx
0.362	57O40-3636-xxxx

Elastomer Core Mesh Gaskets

P-Type "P"

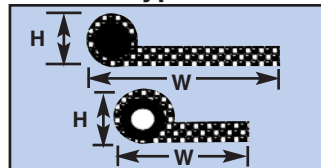

W	H	Part Number
0.138	0.512	57P46-1451-xxxx
0.138	0.638	57P46-1464-xxxx
0.138	0.795	57P46-1480-xxxx
0.205	0.516	57P46-2152-xxxx
0.205	0.768	57P46-2177-xxxx
0.264	0.764	57P46-2676-xxxx

Rectangular Type "R"

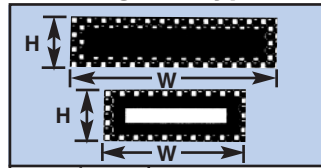

W	H	Part Number
0.138	0.059	57R46-1406-xxxx
0.142	0.098	57R46-1410-xxxx
0.181	0.102	57R46-1810-xxxx
0.189	0.189	57R46-1919-xxxx
0.197	0.118	57R46-2012-xxxx
0.236	0.118	57R46-2412-xxxx
0.252	0.063	57R46-2506-xxxx
0.256	0.157	57R46-2616-xxxx
0.256	0.177	57R46-2618-xxxx
0.354	0.118	57R46-3512-xxxx

Round Type "O"

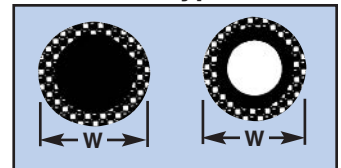

W	Part Number
0.039	57O46-0404-xxxx
0.059	57O46-0606-xxxx
0.079	57O46-0808-xxxx
0.102	57O46-1010-xxxx
0.138	57O46-1414-xxxx
0.157	57O46-1616-xxxx
0.185	57O46-1919-xxxx
0.217	57O46-2222-xxxx
0.307	57O46-3131-xxxx
0.362	57O46-3636-xxxx

Double P-Type "V"

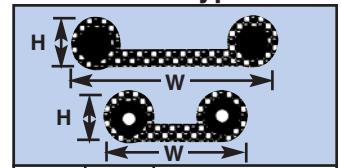

W	H	Part Number
0.138	0.386	57V46-1439-xxxx
0.138	0.512	57V46-1451-xxxx
0.138	0.638	57V46-1464-xxxx
0.205	1.016	57V46-2100-xxxx
0.205	0.642	57V46-2164-xxxx
0.205	0.768	57V46-2177-xxxx
0.264	1.012	57V46-2600-xxxx
0.264	0.638	57V46-2669-xxxx
0.264	0.764	57V46-2676-xxxx

NOTE: All dimensions in inches



Conductive Elastomers

API's Spectrum Control line of conductive elastomers are composed of silicon rubber using its heat resistant property. Unique features of conductive elastomers include water resistance and elimination of static electricity, which is different from general foam gaskets. It also acts as an absorber at high frequency showing 60dB shielding at 30MHz ~ 10GHz.

Excellent electrical conductivity, grounding and shielding are provided. Due to its superior properties conductive elastomers are often used in military equipment. They can be produced in many forms such as sheets, molded parts, die-cuts or strips.

Typical Properties of Silicone Gaskets

Material	Conductive Silicone (Rubber) Gasket
Hardness Shore Micro	97-5
Volume Resistivity ohms	5-10
Elongation %	240
Tensile Strength Mpa	4.43
Tear Resistance KN/m	10.4
Texture and Color	Black or Beige
Specific Gravity	1.39
Temperature Range	-55 to +200

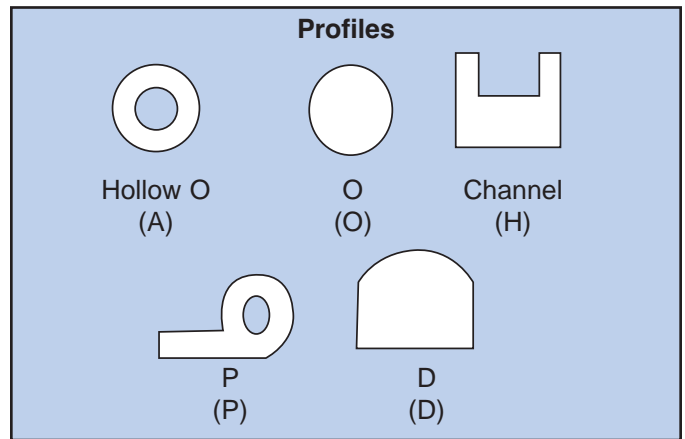

Part Number	ID Size	OD Size	Type	Profile
57A99-0606-xxxx	0.019	0.059	Hollow	A
57A99-0909-xxxx	0.039	0.091	Hollow	A
57A99-2828-xxxx	0.196	0.276	Hollow	A
57D98-2525-xxxx	W:0.250	H:0.250	D-Tubing	D
57H98-3022-xxxx	W:0.295	H:0.217	Channel	H
57O98-1414-xxxx		0.138	O-Profile	O
57P98-9830-xxxx	W:0.984	H:0.295	P-Shape	P

NOTE: All dimensions in inches

Mouser Electronics

Authorized Distributor

Click to View Pricing, Inventory, Delivery & Lifecycle Information:

[API Technologies:](#)

[572019-00109-70](#) [572019-00100-70](#) [572019-00106-70](#) [572019-00103-70](#) [572019-00108-70](#) [572019-00100-AU](#)
[572019-00101-AU](#) [572019-00106-AU](#) [572019-00108-AU](#) [572019-00109-AU](#) [572019-00105-NI](#) [572019-00106-NI](#)
[572019-00108-NI](#) [572019-00103-NI](#) [572019-00102-NI](#) [572019-00102-70](#) [572019-00107-70](#) [572019-00101-70](#)
[572019-00105-70](#) [572019-00104-70](#) [572019-00107-NI](#) [572019-00101-NI](#) [572019-00100-NI](#)