

STK600-ATtiny10

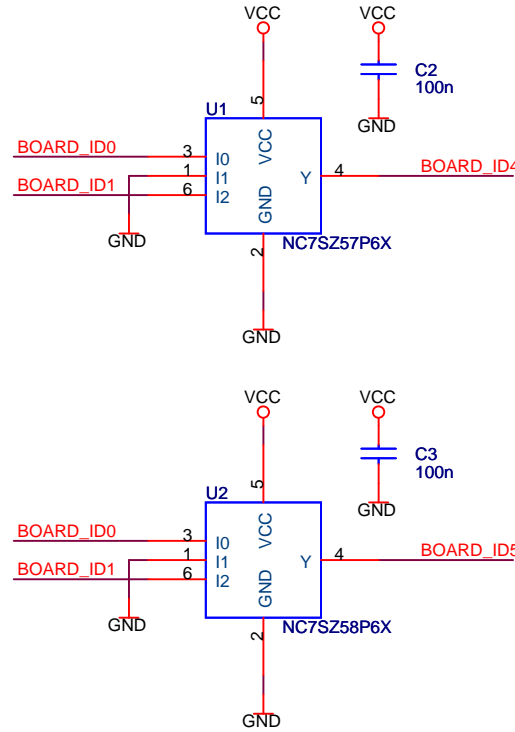

Board id: 0x1E id4: /(A+B) id5: A+B

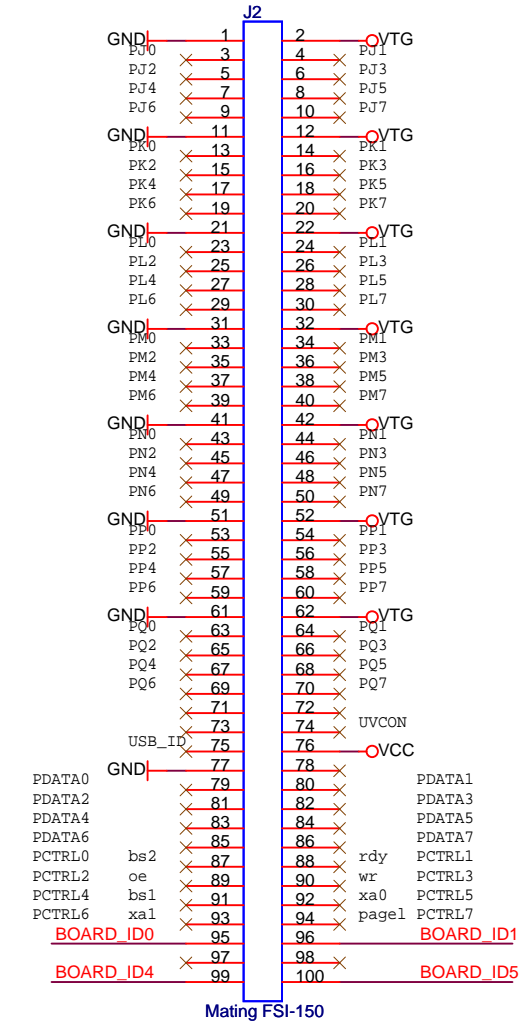
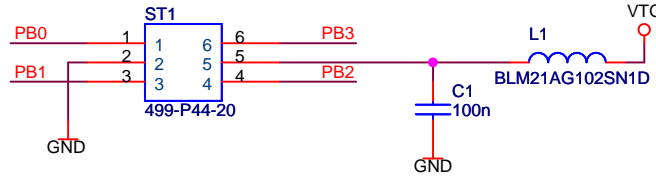
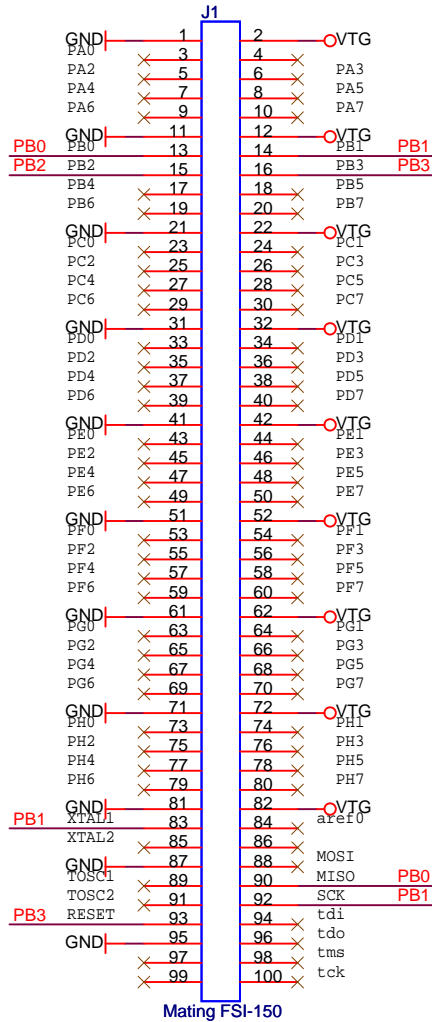
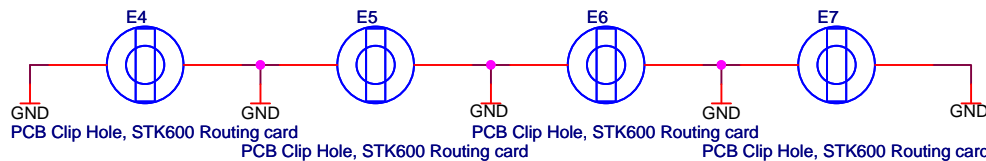
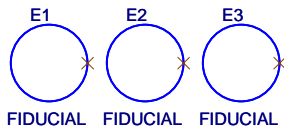
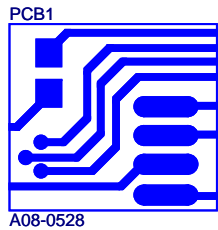

ATMEL Norway AS Vestre Rosten 79 N-7075 TILLER Norway		
Title: STK600-ATtiny10 socket card		
Size: A4	Document Number: <Doc>	Rev: A
Date: Tuesday, July 08, 2008	Sheet: 1 of 1	

Mouser Electronics

Authorized Distributor

Click to View Pricing, Inventory, Delivery & Lifecycle Information:

[Microchip:](#)

[ATSTK600-ATTINY10](#)