

Copying of this document and giving it to others and the use or communication of the contents thereof, are forbidden without express authority. Offenders are liable to the payment of damages. All rights are reserved in the event of the grant of a patent or the registration of the utility model or design.

Weitergabe sowie Vervielfältigung dieser Unterlage, Verwertung und Mitteilung ihres Inhalts nicht gestattet, soweit nicht ausdrücklich zugestanden. Zuwiderhandlungen verpflichten zu Schadenersatz. Alle Rechte für den Fall der Patenterteilung oder Gebrauchsmuster-Eintragung vorbehalten.

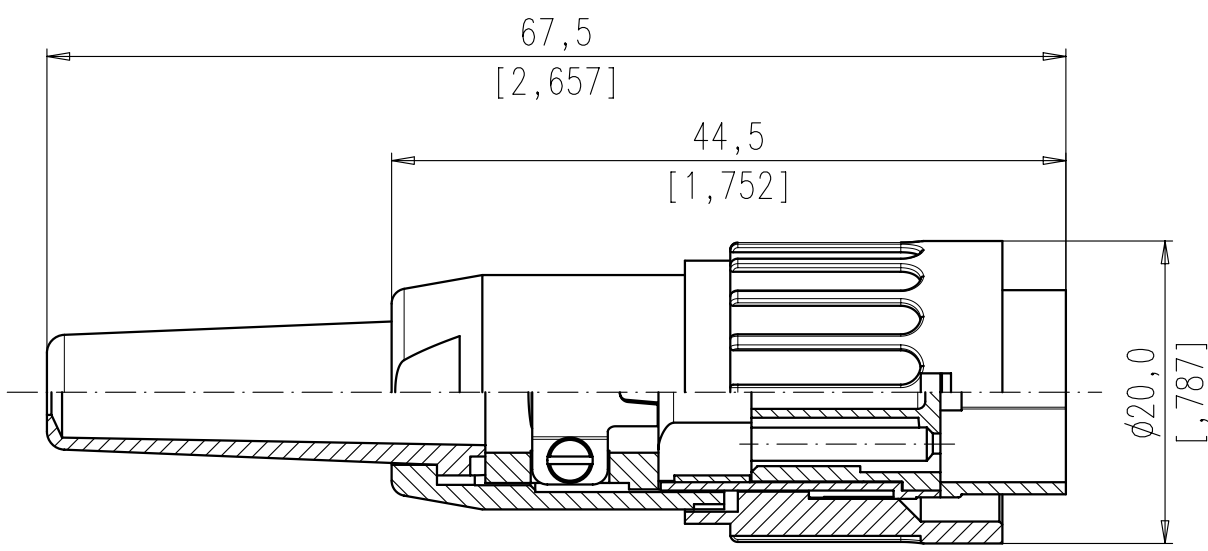

Polzahl number of contacts	Norm standard	3	4	5	5	6	7	7	8	12	14	
D Kontaktanordnung nach DIN contact arrangement acc. to DIN Kontaktanordnung nach IEC contact arrangement acc. to IEC		41524 60130-9	- 60130-9	- -	41524 60130-9	45322 60130-9	- -	45329 60130-9	45326 60130-9	- -	- -	
Bemessungsspannung rated voltage	IEC 60664-1	300V =		100V =		300V =		100V =		150V =		
Bemessungsspannung rated voltage	UL 1977	250V										60V
Bemessungs-Stoßspannung rated impulse withstand voltage	IEC 60664-1	1500V		1200V		1500V		1200V				
Verschmutzungsgrad pollution degree	IEC 60664-1	1										
Überspannungskategorie installation category	IEC 60664-1	I										
C Isolierstoffgruppe insulation group	IEC 60664-1	II, 400 ≤ CTI < 600										
Strombelastbarkeit current rating	IEC 60512-5-2 Test 5b UL 1977	5A / +40°C / +104°F								3A / +40°C / +104°F		
Isolationswiderstand insulation resistance	IEC 60512-3-1 Test 3a	>10 ¹⁰ Ω										
Durchgangswiderstand contact resistance	IEC 60512-2-1 Test 2a	< 5m Ω										
Prüfklasse climatic category	IEC 60068-1	40 / 100 / 56										
Temperaturbereich temperatur range	IEC 60068-1	-40°C ... +100°C -40°F ... +212°F										
B IP-Schutzart IP-degree	IEC 60529	IP 40										
Steck- und Ziehkraft Insertion and withdrawal forces	IEC 60512-13-2 Test 13b	25N 90.oz	30N 110.oz	35N 125.oz	50N 180.oz	55N 200.oz	60N 220.oz	50N 180.oz				
Mechanische Lebensdauer mechanical operation	IEC 60512-9-1 Test 9a	silber/silver ≥ 500 Steckzyklen/mating cycles gold/gold ≥ 1000 Steckzyklen/mating cycles										
Werkstoff Gehäuse housing material		Überwurfmutter Messing, Zugentlastung Zink-Druckguß, Oberfläche vernickelt coupling ring brass, strain relief, die cast, nickel plated										
Werkstoff Kontaktträger dielectric material		Thermoplast thermoplastic										
Kontaktoberfläche contact plating		versilbert/vergoldet silver plated/gold plated										
Anschlusstechnik termination technique		crimpen crimp										
A Anschlussquerschnitt wire gauge		crimp: 2-6 pol(ausschließlich/excluding 5S): 0,09-1,00mm ² / 28-18 AWG crimp 5S, 7, 7S, 8 pol: 0,09-0,75mm ² / 28-20 AWG										
Brennbarkeit flammability		UL 94 V0										
Verriegelung locking system		Bajonett bayonet										

	8 IEC	T 3524 551
	7 IEC	T 3444 551 ¹⁾
	7	T 3434 551
	6	T 3424 551
	5	T 3374 551
	5 IEC	T 3394 551
	4	T 3324 551
	3	T 3274 551
SYMBOL symbol	POLZAHL number of contacts	TYP-NUMMER-CRIMP type-number-crimp

Diese Steckverbinder dürfen betriebsmäßig nicht unter Spannung betätigt werden. Metallene Gehäuseteile sind sicher mit dem Schutzleitersystem zu verbinden.
 Do not connect or disconnect under load. Metal housing parts shall be securely incorporated to protected ground.

1) Lieferbar auf Anfrage
 available on request

Crimpkontakte bitte separat bestellen, Details siehe M-N 01 015 00XX X oder Katalog C091 A/B/D Seite 43
 please order crimp contacts separately, details see M-N 01 015 00XX X or catalog C091 A/B/D page 43

Gewicht (errechnet)/ Calc WT:	9	Zul. Abw./Tolerances:		Maßstab/Scale	2:1	A3	
Prüfmaß/Testdimension				CUSTOMER DRAWING			
Teileindex Partindexnumber				Kabelstecker gerade Male cable connector			
		07	Datum/Date	Name			
		Gez.	24.04.	Carle			
		Drawn					
		Gepr.					
		Checked					
02	200700144	04.07.08	CI	Amphenol-Tuchel Electronics GmbH			
01	200700144	24.04.07	CM	M	HB T 3XX4 551	Blatt/Sheet 1 1 Bl.	
Index	Änderung/Description	Datum/Date	Name	Ers. f./Similar to:			

Mouser Electronics

Authorized Distributor

Click to View Pricing, Inventory, Delivery & Lifecycle Information:

[Amphenol:](#)

[T3374-551](#) [T 3378 501](#)