

## Choke Coils Discontinued

Series : **Pin terminal**  
 Type : **09D, 11D, 12D, 16B, 18B, 10E, 12E, 15E, 18E**

Pin terminal inductors featuring small size and high performance

### Features

- High -  $\mu$  and High Bm cores
- Wide inductor range
- Magnetic shield type (E Type)
- RoHS compliant

### Recommended Applications

- Appliance, Office automation equipment, Amusement machine, Power circuit for electric device



### Explanation of Part Numbers

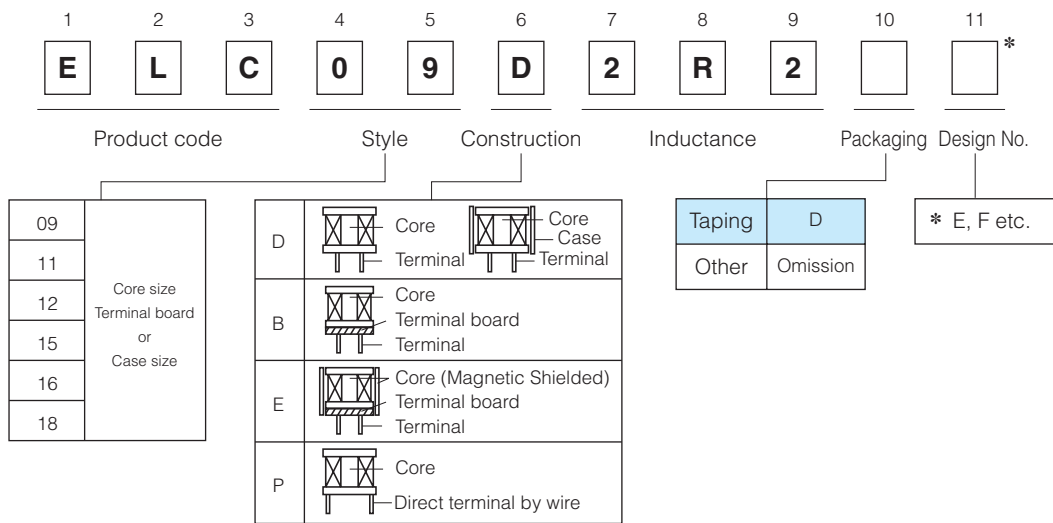



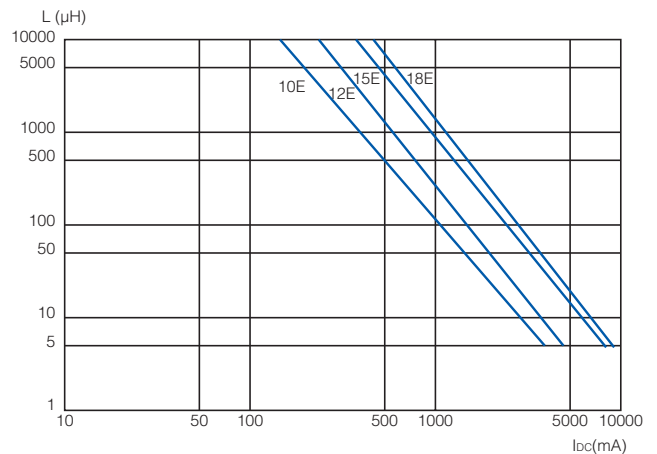
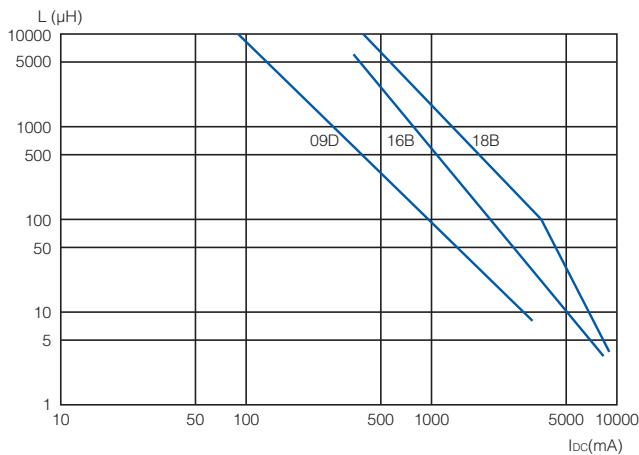



### Available I-L Characteristics

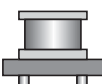

Discontinued

## Performance Characteristics by Series

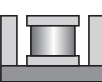
	Type	Construction	External Dimensions D×H (mm)	Inductance (μH)					Current I <sub>DC</sub> (A)	
				0.1	1.0	10	100	1000		10000
Regular	09D *		φ9.5×8.9 (with case)			2.2			10000	0.08 to 3.5
	11D *		φ11.5×13.9 (with case)			2.2			10000	0.16 to 5.3
	12D		φ12.5×16.5				100		10000	0.27 to 1.9
	16B		φ16.0×23.0			3.3			10000	0.26 to 8.5
	18B		φ20.0×27.0			3.3			10000	0.36 to 8.5
Shield	10E-L		φ10.0×13.0			3.9			8200	0.10 to 2.9
	12E-L		φ13.0×18.5			4.7			10000	0.13 to 4.4
	15E-L		φ16.0×22.0 (3 pin terminal)			5.6			10000	0.30 to 5.4
	18E-L		φ19.0×25.1 (4 pin terminal)			5.6			10000	0.33 to 5.9

\* : Taping Available

Discontinued

## Examples Type 10E-L

	Part No.	Inductance (μH)	Tolerance (%)	Test Freq. (kHz)	R <sub>DC</sub> (Ω) [at 20 °C] (Tol. ±20 %)	I <sub>DC</sub> * [at 20 °C] (A)max.
[Dimensions in mm] (not to scale)	ELC10E3R9L	3.9	±20	10	0.024	2.90
	ELC10E4R7L	4.7			0.027	2.80
	ELC10E5R6L	5.6			0.030	2.70
	ELC10E6R8L	6.8			0.032	2.60
	ELC10E8R2L	8.2			0.035	2.50
	ELC10E100L	10.0			0.038	2.40
	ELC10E120L	12.0			0.040	2.30
	ELC10E150L	15.0			0.046	2.20
	ELC10E180L	18.0			0.049	2.10
	Recommended PWB piercing plan	ELC10E220L			22.0	±15
ELC10E270L		27.0	0.062		1.90	
ELC10E330L		33.0	0.068		1.80	
ELC10E390L		39.0	0.074		1.70	
ELC10E470L		47.0	0.098		1.50	
ELC10E560L		56.0	0.120		1.30	
ELC10E680L		68.0	0.150		1.20	
ELC10E820L		82.0	0.190		1.00	
ELC10E101L		100.0	0.210		0.96	
ELC10E121L		120.0	0.240		0.92	
Connection Schematic	ELC10E151L	150.0	±10		0.260	0.83
	ELC10E181L	180.0			0.290	0.74
	ELC10E221L	220.0			0.410	0.64
	ELC10E271L	270.0			0.590	0.54
	ELC10E331L	330.0			0.660	0.52
	ELC10E391L	390.0			0.720	0.50
	ELC10E471L	470.0			0.800	0.45
	ELC10E561L	560.0			1.100	0.41
	ELC10E681L	680.0			1.200	0.37
	ELC10E821L	820.0			1.600	0.33
	ELC10E102L	1000.0	1.800		0.31	
	ELC10E122L	1200.0	2.000	0.29		
	ELC10E152L	1500.0	2.800	0.26		
	ELC10E182L	1800.0	3.200	0.23		
	ELC10E222L	2200.0	3.600	0.20		
	ELC10E272L	2700.0	5.200	0.18		
	ELC10E332L	3300.0	5.900	0.17		
	ELC10E392L	3900.0	6.500	0.16		
	ELC10E472L	4700.0	9.600	0.14		
	ELC10E562L	5600.0	10.800	0.12		
	ELC10E682L	6800.0	11.900	0.11		
	ELC10E822L	8200.0	13.200	0.10		

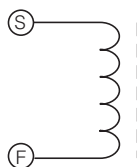
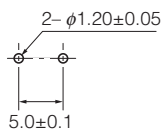
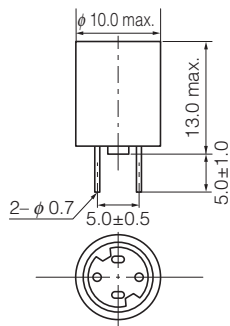

\* Allowable DC Current: Smaller current value either when the inductance is -10 % or when the case temperature has risen 45 °C.

Discontinued

Examples Type 12E-L

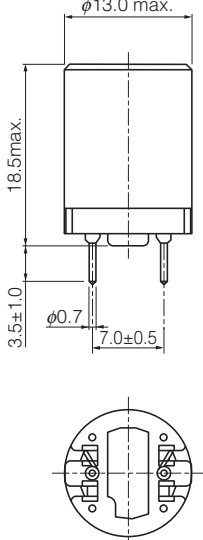
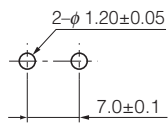
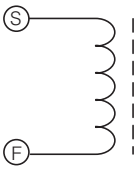
	Part No.	Inductance (μH)	Tolerance (%)	Test Freq. (kHz)	R <sub>DC</sub> (Ω) [at 20 °C] (Tol.±20 %)	I <sub>DC</sub> * [at 20 °C] (A)max.
<p>[Dimensions in mm] (not to scale)</p>  <p>Recommended PWB piercing plan</p>  <p>Connection Schematic</p> 	ELC12E4R7L	4.7	±25	10	0.014	4.40
	ELC12E5R6L	5.6			0.016	4.10
	ELC12E6R8L	6.8			0.018	3.90
	ELC12E8R2L	8.2			0.020	3.70
	ELC12E100L	10.0	±20		0.023	3.50
	ELC12E120L	12.0			0.024	3.30
	ELC12E150L	15.0			0.028	3.20
	ELC12E180L	18.0			0.030	3.10
	ELC12E220L	22.0	±10		0.033	2.80
	ELC12E270L	27.0			0.037	2.50
	ELC12E330L	33.0			0.041	2.40
	ELC12E390L	39.0			0.044	2.20
	ELC12E470L	47.0			0.048	2.00
	ELC12E560L	56.0			0.053	1.80
	ELC12E680L	68.0			0.073	1.70
	ELC12E820L	82.0			0.098	1.40
	ELC12E101L	100.0			0.140	1.30
	ELC12E121L	120.0			0.160	1.20
	ELC12E151L	150.0	0.180		1.10	
	ELC12E181L	180.0	0.200		1.00	
	ELC12E221L	220.0	0.220		0.91	
	ELC12E271L	270.0	0.320		0.83	
	ELC12E331L	330.0	0.360		0.79	
	ELC12E391L	390.0	0.400		0.70	
	ELC12E471L	470.0	0.440		0.64	
	ELC12E561L	560.0	0.490		0.57	
	ELC12E681L	680.0	0.610		0.52	
	ELC12E821L	820.0	0.760		0.47	
	ELC12E102L	1000.0	1.100		0.43	
	ELC12E122L	1200.0	1.200		0.40	
	ELC12E152L	1500.0	1.400		0.36	
	ELC12E182L	1800.0	1.900		0.32	
	ELC12E222L	2200.0	2.500		0.30	
ELC12E272L	2700.0	3.500	0.26			
ELC12E332L	3300.0	3.900	0.24			
ELC12E392L	3900.0	4.300	0.22			
ELC12E472L	4700.0	6.000	0.20			
ELC12E562L	5600.0	6.600	0.17			
ELC12E682L	6800.0	9.900	0.15			
ELC12E822L	8200.0	10.900	0.14			
ELC12E103L	10000.0	12.200	0.13			

\* Allowable DC Current: Smaller current value either when the inductance is -10 % or when the case temperature has risen 45 °C.

## Discontinued

### Examples Type 15E-L

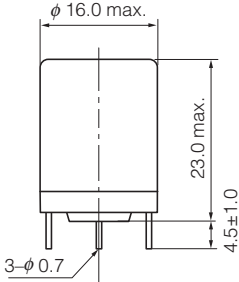
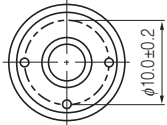
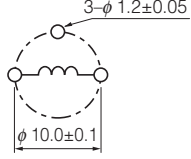
	Part No.	Inductance (μH)	Tolerance (%)	Test Freq. (kHz)	R <sub>DC</sub> (Ω) [at 20 °C] (Tol. ±20 %)	I <sub>DC</sub> * [at 20 °C] (A)max.
<p>[Dimensions in mm] (not to scale)</p>   <p>Recommended PWB piercing plan</p> 	ELC15E5R6L	5.6	±20	10	0.012	6.80
	ELC15E6R8L	6.8			0.013	6.30
	ELC15E8R2L	8.2			0.016	5.80
	ELC15E100L	10			0.018	5.40
	ELC15E120L	12			0.019	5.10
	ELC15E150L	15			0.022	4.70
	ELC15E180L	18			0.024	4.50
	ELC15E220L	22			0.027	4.30
	ELC15E270L	27			0.029	4.10
	ELC15E330L	33			0.032	4.00
	ELC15E390L	39			0.033	3.80
	ELC15E470L	47			0.037	3.70
	ELC15E560L	56			0.039	3.60
	ELC15E680L	68			0.045	3.50
	ELC15E820L	82			0.048	3.20
	ELC15E101L	100	0.053		3.00	
	ELC15E121L	120	0.059		2.60	
	ELC15E151L	150	0.077		2.40	
	ELC15E181L	180	0.100		2.30	
	ELC15E221L	220	0.140		2.00	
	ELC15E271L	270	0.150		1.70	
	ELC15E331L	330	0.170		1.60	
	ELC15E391L	390	0.190		1.50	
	ELC15E471L	470	0.210		1.30	
	ELC15E561L	560	0.280		1.20	
	ELC15E681L	680	0.310		1.10	
	ELC15E821L	820	0.440		1.00	
	ELC15E102L	1000	0.490		0.95	
	ELC15E122L	1200	0.540		0.85	
	ELC15E152L	1500	0.710		0.80	
	ELC15E182L	1800	0.870		0.75	
	ELC15E222L	2200	1.100		0.63	
	ELC15E272L	2700	1.400		0.60	
ELC15E332L	3300	1.600	0.53			
ELC15E392L	3900	1.700	0.47			
ELC15E472L	4700	2.400	0.43			
ELC15E562L	5600	2.600	0.39			
ELC15E682L	6800	2.900	0.36			
ELC15E822L	8200	3.500	0.34			
ELC15E103L	10000	4.600	0.30			

\* Allowable DC Current: Smaller current value either when the inductance is -10 % or when the case temperature has risen 45 °C.

## Discontinued

### Examples Type 18E-L

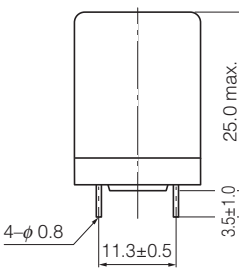
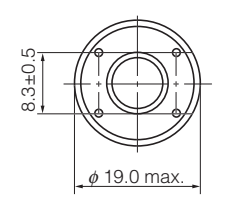
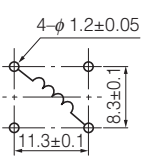
	Part No.	Inductance (μH)	Tolerance (%)	Test Freq. (kHz)	R <sub>DC</sub> (Ω) [at 20 °C] (Tol. ±20 %)	I <sub>DC</sub> * [at 20 °C] (A)max.
<p>[Dimensions in mm] (not to scale)</p>   <p>Recommended PWB piercing plan</p>  <p>(Top View)</p>	ELC18E5R6L	5.6	±20	10	0.011	6.70
	ELC18E6R8L	6.8			0.013	6.50
	ELC18E8R2L	8.2			0.013	6.20
	ELC18E100L	10			0.014	5.90
	ELC18E120L	12			0.016	5.60
	ELC18E150L	15			0.017	5.40
	ELC18E180L	18			0.019	5.20
	ELC18E220L	22			0.022	5.00
	ELC18E270L	27			0.023	4.80
	ELC18E330L	33			0.026	4.60
	ELC18E390L	39			0.028	4.50
	ELC18E470L	47			0.030	4.10
	ELC18E560L	56			0.031	3.80
	ELC18E680L	68			0.036	3.60
	ELC18E820L	82	0.040		3.50	
	ELC18E101L	100	0.044		3.00	
	ELC18E121L	120	0.047		2.80	
	ELC18E151L	150	0.061		2.60	
	ELC18E181L	180	0.067		2.50	
	ELC18E221L	220	0.076		2.10	
	ELC18E271L	270	0.083		2.00	
	ELC18E331L	330	0.110		1.90	
	ELC18E391L	390	0.120		1.80	
	ELC18E471L	470	0.150		1.50	
	ELC18E561L	560	0.170		1.40	
	ELC18E681L	680	0.190		1.20	
	ELC18E821L	820	0.210		1.10	
	ELC18E102L	1000	0.280		1.00	
	ELC18E122L	1200	0.360		0.95	
	ELC18E152L	1500	0.510		0.90	
	ELC18E182L	1800	0.570		0.80	
	ELC18E222L	2200	0.630		0.73	
	ELC18E272L	2700	0.890		0.65	
	ELC18E332L	3300	1.000		0.60	
ELC18E392L	3900	1.100	0.50			
ELC18E472L	4700	1.400	0.48			
ELC18E562L	5600	1.600	0.46			
ELC18E682L	6800	2.200	0.39			
ELC18E822L	8200	2.400	0.35			
ELC18E103L	10000	2.700	0.33			
			±10			

\* Allowable DC Current: Smaller current value either when the inductance is -10 % or when the case temperature has risen 45 °C.

Tape Dimensions in mm for Type 09D (not to scale)

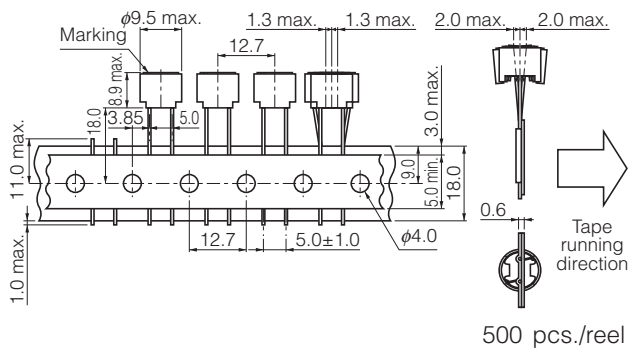

Tape Dimensions in mm for Type 11D (not to scale)

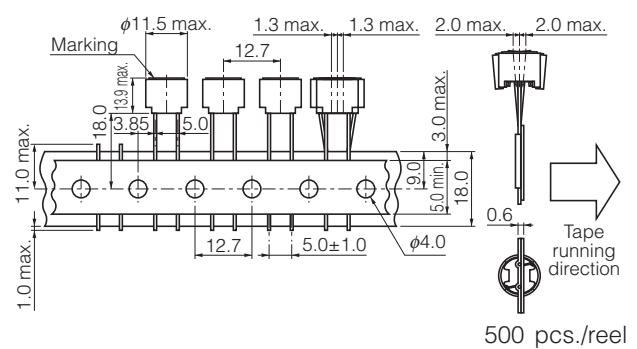

### ⚠ Safety Precautions

- When using our products, no matter what sort of equipment they might be used for, be sure to make a written agreement on the specifications with us in advance. The design and specifications in this catalog are subject to change without prior notice.
- Do not use the products beyond the specifications described in this catalog.
- This catalog explains the quality and performance of the products as individual components. Before use, check and evaluate their operations when installed in your products.
- Install the following systems for a failsafe design to ensure safety if these products are to be used in equipment where a defect in these products may cause the loss of human life or other significant damage, such as damage to vehicles (automobile, train, vessel), traffic lights, medical equipment, aerospace equipment, electric heating appliances, combustion/gas equipment, rotating equipment, and disaster/crime prevention equipment.
- \* Systems equipped with a protection circuit and a protection device
- \* Systems equipped with a redundant circuit or other system to prevent an unsafe status in the event of a single fault

### ⚠ Precautions for use

#### 1. Rated current

The rated current is defined as the smaller value of either the current value when the inductance drops 10 % down from its initial point, or when the average temperature of coil interior rises 45 °C up on power source. Do not operate these coils beyond the specified rated current.

#### 2. Mounting

- ① Cores may be damaged when excessive force or shock is applied.  
Do not use products which may have been dropped.
- ② Be careful not to make contact with other parts and consider possible interaction between coils due to magnetic interference.
- ③ Be careful of being too close to heat-radiating parts (high temperature).
- ④ Do not bend the pin-terminals during assembly.  
The pin-terminals must connect correctly.  
Do not apply them a shock to avoid causing an open or short circuit condition.
- ⑤ The float on PWB must not be after mounting.

#### 3. Soldering

- ① Use flux which will not effect copper wire. (Be sure to use proper amounts of chloride, pH and other solvents)
- ② When using a soldering iron, wait at least 3 minutes before attempting to re-solder.

#### 4. Storage

- ① Avoid high temperatures, high moisture, gases and magnetic fields.
- ② For long term storage of more than 1 year, use the products only after inspecting their outer structure.  
(Look for possible rusting of the core and oxidation of the lead wire, which would affect its solderability.)

#### <Package markings>

Package markings include the product number, quantity, and country of origin. In principle, the country of origin should be indicated in English.

# Mouser Electronics

Authorized Distributor

Click to View Pricing, Inventory, Delivery & Lifecycle Information:

## Panasonic:

[ELC-10E100L](#) [ELC-10E101L](#) [ELC-10E102L](#) [ELC-10E121L](#) [ELC-10E122L](#) [ELC-10E150L](#) [ELC-10E151L](#) [ELC-10E152L](#) [ELC-10E180L](#) [ELC-10E181L](#) [ELC-10E182L](#) [ELC-10E220L](#) [ELC-10E222L](#) [ELC-10E270L](#) [ELC-10E271L](#) [ELC-10E272L](#) [ELC-10E331L](#) [ELC-10E390L](#) [ELC-10E392L](#) [ELC-10E3R9L](#) [ELC-10E470L](#) [ELC-10E472L](#) [ELC-10E560L](#) [ELC-10E561L](#) [ELC-10E562L](#) [ELC-10E5R6L](#) [ELC-10E680L](#) [ELC-10E681L](#) [ELC-10E682L](#) [ELC-10E6R8L](#) [ELC-10E820L](#) [ELC-10E821L](#) [ELC-10E822L](#) [ELC-10E8R2L](#) [ELC-12E100L](#) [ELC-12E120L](#) [ELC-12E121L](#) [ELC-12E122L](#) [ELC-12E150L](#) [ELC-12E151L](#) [ELC-12E152L](#) [ELC-12E180L](#) [ELC-12E182L](#) [ELC-12E220L](#) [ELC-12E222L](#) [ELC-12E270L](#) [ELC-12E271L](#) [ELC-12E272L](#) [ELC-12E330L](#) [ELC-12E332L](#) [ELC-12E390L](#) [ELC-12E391L](#) [ELC-12E392L](#) [ELC-12E472L](#) [ELC-12E4R7L](#) [ELC-12E560L](#) [ELC-12E561L](#) [ELC-12E562L](#) [ELC-12E5R6L](#) [ELC-12E681L](#) [ELC-12E682L](#) [ELC-12E6R8L](#) [ELC-12E820L](#) [ELC-12E821L](#) [ELC-12E822L](#) [ELC-12E8R2L](#) [ELC-18E100L](#) [ELC-18E101L](#) [ELC-18E120L](#) [ELC-18E121L](#) [ELC-18E122L](#) [ELC-18E150L](#) [ELC-18E151L](#) [ELC-18E152L](#) [ELC-18E180L](#) [ELC-18E181L](#) [ELC-18E182L](#) [ELC-18E220L](#) [ELC-18E221L](#) [ELC-18E271L](#) [ELC-18E272L](#) [ELC-18E330L](#) [ELC-18E331L](#) [ELC-18E332L](#) [ELC-18E390L](#) [ELC-18E391L](#) [ELC-18E392L](#) [ELC-18E470L](#) [ELC-18E471L](#) [ELC-18E472L](#) [ELC-18E560L](#) [ELC-18E561L](#) [ELC-18E562L](#) [ELC-18E5R6L](#) [ELC-18E680L](#) [ELC-18E681L](#) [ELC-18E682L](#) [ELC-18E6R8L](#) [ELC-18E820L](#) [ELC-18E821L](#)