

DESCRIPTION: MALE - 0.370 RIGHT ANGLE / MACHINED

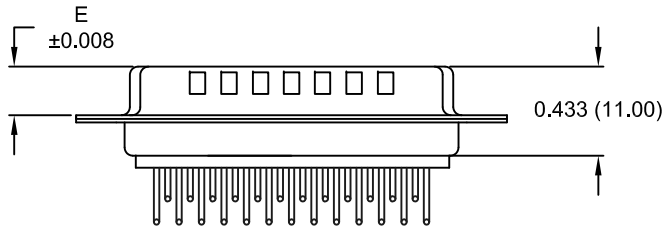
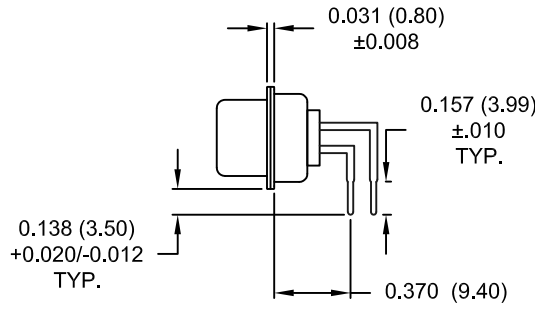
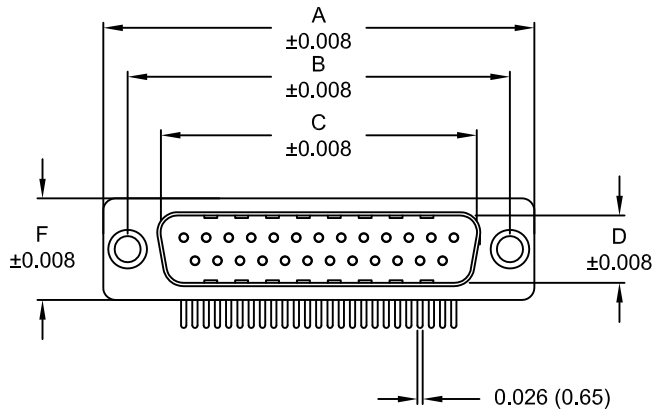

DIMENSIONS (inch/mm)						
No. OF PINS	A	B	C	D	E	F
9	1.213	0.984	0.665	0.327	0.240	0.492
	30.80	25.00	16.90	8.30	6.10	12.50
15	1.543	1.311	0.994	0.327	0.240	0.492
	39.20	33.30	25.25	8.30	.6.10	12.50
25	2.089	1.852	1.533	0.327	0.240	0.492
	53.05	47.05	38.95	8.30	6.10	12.50

774-EYY-11YRYY1

- SERIES _____
- POSITIONS _____
- E09
 - E15
 - E25
- GENDER _____
- 1 = MALE
- TERMINATION _____
- 1 = PC MOUNTING
- SHELL PLATING _____
- 3 = NICKEL (GROUND INDENTS)
- RoHS COMPLIANT _____
- HARDWARE OPTIONS _____
- 00 = NO HARDWARE
 - 01 = 0.098" CLINCH NUT (BOARD SIDE)
 - 14 = SHORT BRACKET WITH 4-40 SCREW LOCK
 - 24 = SHORT BRACKET WITH 4-40 SCREW
 - 46 = BRACKET WITH 4-40 INSERT AND BOARDLOCK
- PLATING OPTIONS _____
- 1 = GOLD FLASH
 - 2 = 30MICRO-INCH GOLD
 - 3 = 50 MICRO-INCH GOLD

MEETS IP67 STANDARDS
(SEE PAGE 3 FOR SEALING DETAILS)

MATERIAL:

- SHELL: STEEL, NICKEL PLATED
- INSULATOR: UL 94V-O RATED, WHITE PA6T
- PROCESS TEMP.: 260° PROCESS TEMPERATURE
- CONTACT: PRECISION MACHINED COPPER ALLOY
- SEALING MATERIAL: FLEXIBLE F08 ADHESIVE

ELECTRICAL:

- CURRENT RATING: 5 AMPS
- CONTACT RESISTANCE: 10 mOhms Max.
- INSULATION RESISTANCE: 5 GOhms Min.
- VOLTAGE: 1000 V AC FOR 1 MINUTE
- TEMPERATURE: -55° C TO +125° C

RoHS COMPLIANT

UNITS = inch [mm]

DO NOT SCALE FROM DRAWING

	THESE DRAWINGS AND SPECIFICATIONS ARE THE PROPERTY OF NorComp AND SHALL NOT BE REPRODUCED, COPIED OR USED AS THE BASIS FOR THE MANUFACTURE OF SALE OF APPARATUS WITHOUT WRITTEN PERMISSION.		DRAWN: C. SMITH	DATE: 03-26-09
	NorComp		SCALE: NTS	SHEET OF 1 4
DWG NO. 774-EYY-11YRYY1				

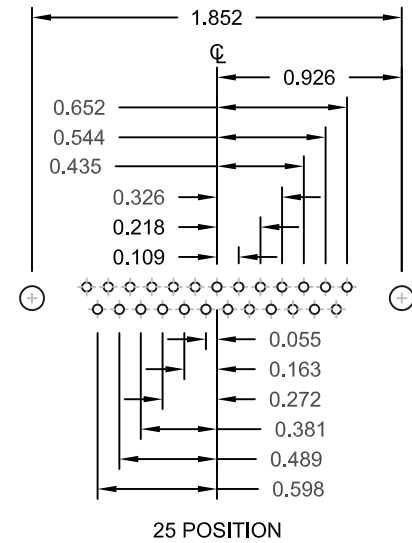
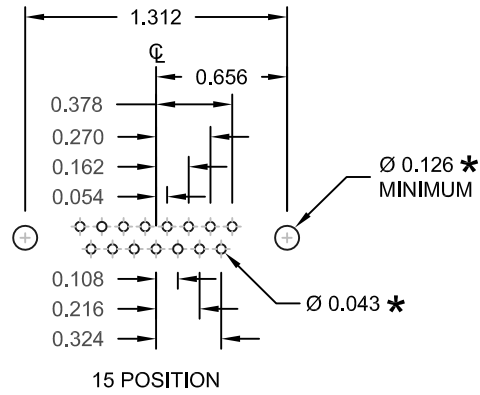
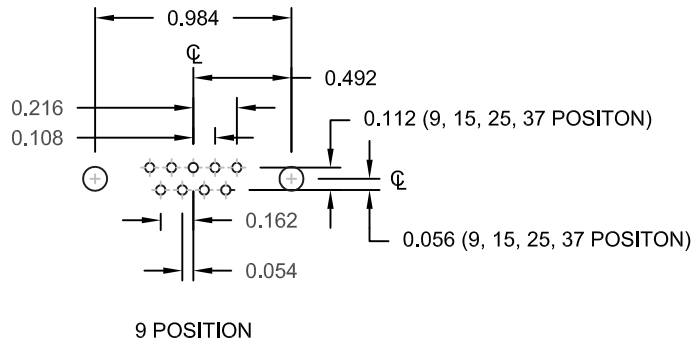

UNITS = inch

* TYP.
SUGGESTED SIZE
MAY NOT BE SUITABLE FOR ALL APPLICATIONS

DO NOT SCALE FROM DRAWING

	THESE DRAWINGS AND SPECIFICATIONS ARE THE PROPERTY OF NorComp AND SHALL NOT BE REPRODUCED, COPIED OR USED AS THE BASIS FOR THE MANUFACTURE OF SALE OF APPARATUS WITHOUT WRITTEN PERMISSION.		DRAWN: C. SMITH	DATE: 03-26-09
	<h1>NorComp</h1>		SCALE: NTS	SHEET OF 2 4
DWG NO. 774-EYY-11YRY1				

DESCRIPTION: IP67 - MALE - MACHINED - SEALING PROCESS

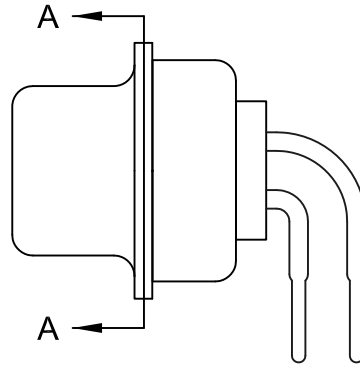

FRONT SEAL APPLIED OVER INSULATOR AND BETWEEN FRONT & REAR SHELLS

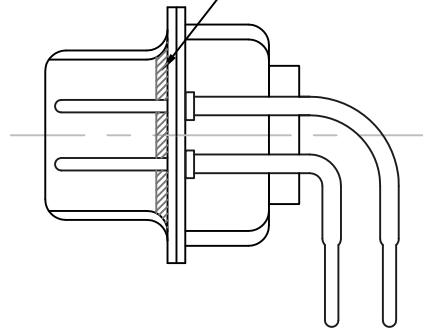

DETAIL A-A

DO NOT SCALE FROM DRAWING



THESE DRAWINGS AND SPECIFICATIONS ARE THE PROPERTY OF NorComp AND SHALL NOT BE REPRODUCED, COPIED OR USED AS THE BASIS FOR THE MANUFACTURE OF SALE OF APPARATUS WITHOUT WRITTEN PERMISSION.

DRAWN:

C. SMITH

DATE:

03-26-09

SCALE:
NTS

SHEET

OF

3

4

REV
8

DWG NO.

774-EYY-11YRY1

RoHS COMPLIANT

NorComp

DESCRIPTION: HARDWARE

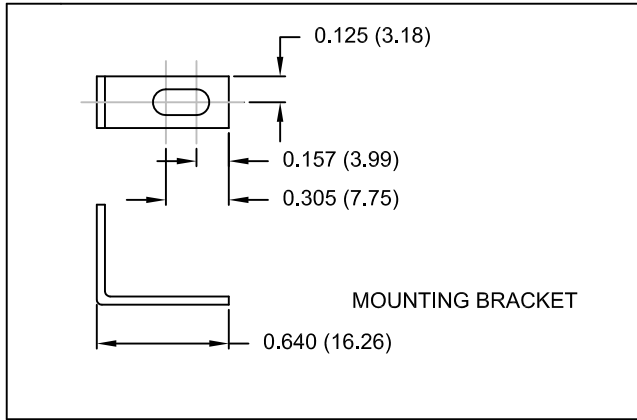

14Y = SHORT BRACKET & 4-40 FEMALE HEX SOCKET
24Y = SHORT BRACKET & 4-40 SCREW

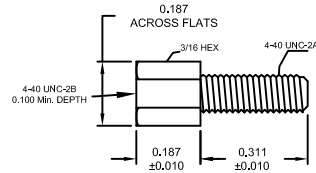

CLINCH-NUT HAS 4-40 INTERNAL THREADS

01X 0.098" (BOARD SIDE)

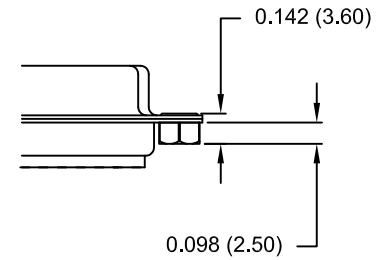

46Y = BRACKET WITH 4-40 INSERT AND BOARDLOCK

9-37 POSITION CONNECTOR BRACKET

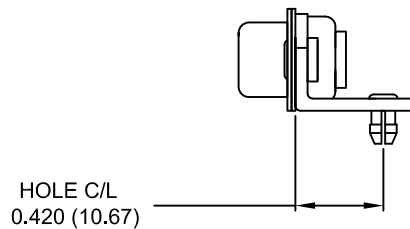

50 POSITION CONNECTOR BRACKET

NOTE: LOCATOR PLATE PRESENT ON 50 PIN ONLY

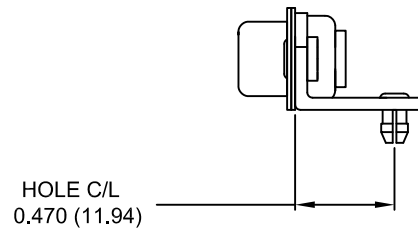

#4-40 THREADED INSERT

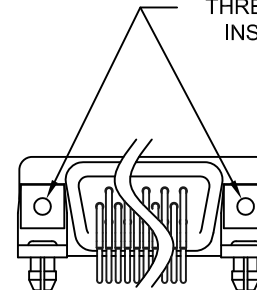

BRACKETS MOUNTED ON CONNECTOR

DO NOT SCALE FROM DRAWING

UNITS = inch [mm]

RoHS COMPLIANT



THESE DRAWINGS AND SPECIFICATIONS ARE THE PROPERTY OF NorComp AND SHALL NOT BE REPRODUCED, COPIED OR USED AS THE BASIS FOR THE MANUFACTURE OF SALE OF APPARATUS WITHOUT WRITTEN PERMISSION.

NorComp

DRAWN: C. SMITH		DATE: 03-26-09	
SCALE: NTS	SHEET 4	OF 4	REV 8
DWG NO. 774-EYY-11YRY1			

Mouser Electronics

Authorized Distributor

Click to View Pricing, Inventory, Delivery & Lifecycle Information:

[NorComp:](#)

[774-E09-113R001](#) [774-E15-113R001](#) [774-E25-113R001](#) [774-E15-113R141](#) [774-E15-113R011](#) [774-E09-113R141](#)
[774-E09-113R011](#) [774-E25-113R011](#) [774-E25-113R141](#)