

THIS DRAWING IS UNPUBLISHED. RELEASED FOR PUBLICATION
 © COPYRIGHT - By - ALL RIGHTS RESERVED.

LOC	DIST	REVISIONS					
FB	00	P	LTR	DESCRIPTION	DATE	DWN	APVD
		P		REVISED PER ECO-11-005033	24MAR11	RK	HMR

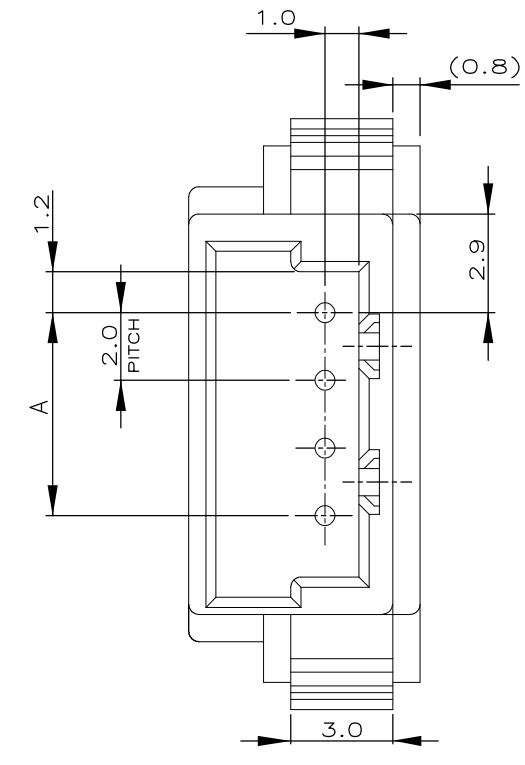
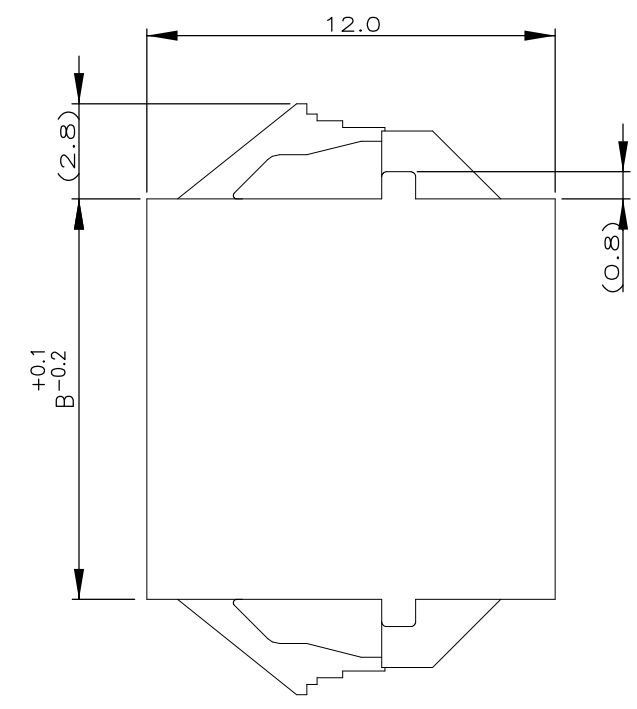
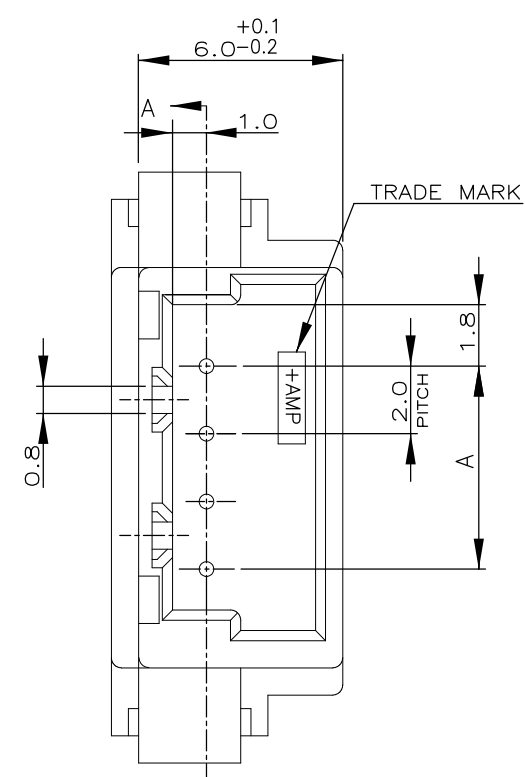

NOTES;

1. MATERIAL: HOUSING - 66 NYLON (UL94V-0)
POST - TIN BRASS
2. THE PANEL SHOULD BE PUNCHED SO THAT THE HOUSING ENTERS THE PANEL IN THE SAME DIRECTION AS PUNCH.

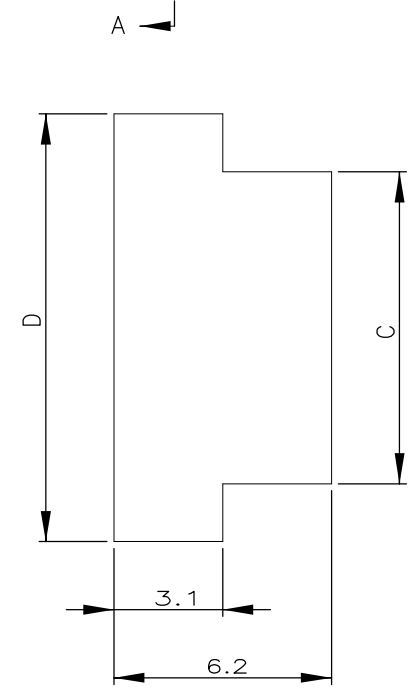
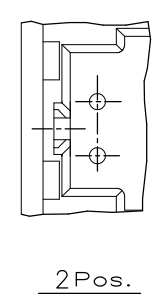
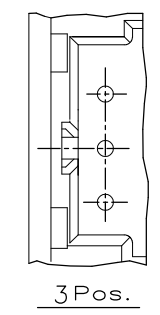

SECT. A-A

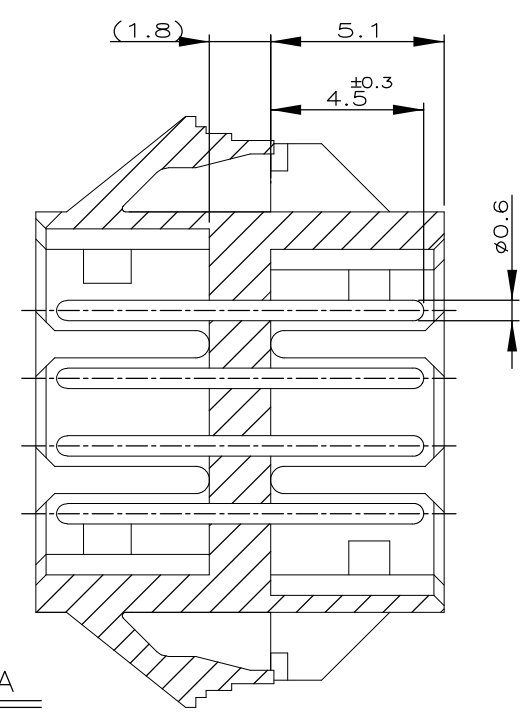

7-292254-5	5-292254-5	3-292254-5	1-292254-5	15	37.6	34.0	33.8	28.0
7-▲-4	5-▲-4	3-▲-4	1-▲-4	14	35.6	32.0	31.8	26.0
7--3	5--3	3--3	1--3	13	33.6	30.0	29.8	24.0
7--2	5--2	3--2	1--2	12	31.6	28.0	27.8	22.0
7--1	5--1	3--1	1--1	11	29.6	26.0	25.8	20.0
7--0	5--0	3--0	1--0	10	27.6	24.0	23.8	18.0
6--9	4--9	2--9		9	25.6	22.0	21.8	16.0
6--8	4--8	2--8		8	23.6	20.0	19.8	14.0
6--7	4--7	2--7		7	21.6	18.0	17.8	12.0
6--6	4--6	2--6		6	19.6	16.0	15.8	10.0
6--5	4--5	2--5		5	17.6	14.0	13.8	8.0
6--4	4--4	2--4		4	15.6	12.0	11.8	6.0
6--3	4--3	2--3		3	13.6	10.0	9.8	4.0
6-292254-2	4-292254-2	2-292254-2	292254-2	2	11.6	8.0	7.8	2.0
BLACK	YELLOW	BLUE	NATURAL	Pos.	D	C	B	A

PANEL CUTOUT DIMENSION (TOLERANCE:±0.1)
 (RECOMMENDED PANE THICKNESS:0.8mm ~ 1.6mm)

TOLERANCES UNLESS OTHERWISE SPECIFIED:

10 ≥ *	: ±0.2
30 ≥ * >10	: ±0.25
100 ≥ * >30	: ±0.3
ANGLE	: ±3°

THIS DRAWING IS A CONTROLLED DOCUMENT.

DIMENSIONS: mm	TOLERANCES UNLESS OTHERWISE SPECIFIED:	DWN S.XU 31JAN03	TE Connectivity PANEL MOUNT TYPE RELAY POST HEADER ASS'Y (AMP CT CONNECTOR 2mm PITCH)
	0 PLC ±- 1 PLC ±- 2 PLC ±- 3 PLC ±- 4 PLC ±- ANGLES ±-	CHK S.YAO 31JAN03	
		APVD T. SASAKI 31JAN03	
		PRODUCT SPEC	
MATERIAL SEE NOTE	FINISH SEE NOTE	NAME	RESTRICTED TO
		APPLICATION SPEC	
		WEIGHT -	SIZE A3 CAGE CODE 00779 DRAWING NO C-292254
		CUSTOMER DRAWING	SCALE 5:1 SHEET 1 OF 1 REV P

Mouser Electronics

Authorized Distributor

Click to View Pricing, Inventory, Delivery & Lifecycle Information:

[TE Connectivity:](#)

[7-292254-3](#)