

DISCRIPTION: DIP SOLDER MALE/STAMPED - SEALED

SPECIFICATIONS:

MATERIALS:

SHELL: STEEL, NICKEL PLATED
 INSULATOR: UL 94V-0 RATED BLACK NYLON 9T
 CONTACT: BRASS
 SEAL: F08 FLEXIBLE ADHESIVE

ELECTRICALS:

CURRENT RATING: 5 AMPS
 CONTACT RESISTANCE: 15 mOHMS MAX
 INSULTOR RESISTANCE: 1000 MOHMS MIN
 VOLTAGE: 500V AC FOR 1 MINUTE
 TEMPERATURE: -50°C TO +100°C

POS.	A	B	C	D	E	F	G
9	1.213	0.984	0.666	0.756	0.329	0.109	0.496
	30.80	24.99	16.92	19.20	8.36	2.77	12.60
15	1.543	1.312	0.994	1.091	0.329	0.109	0.496
	39.19	33.32	25.25	27.70	8.36	2.77	12.60
25	2.087	1.852	1.534	1.618	0.329	0.109	0.496
	53.00	47.04	38.96	41.10	8.36	2.77	12.60

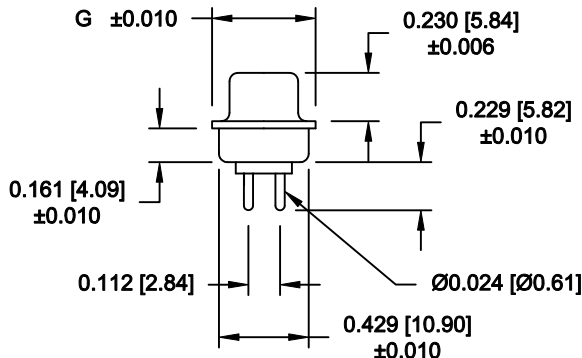
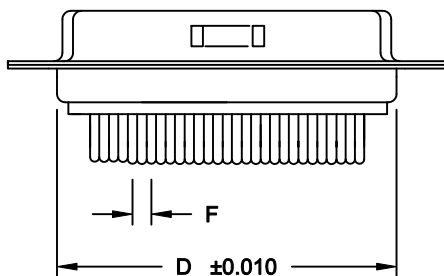
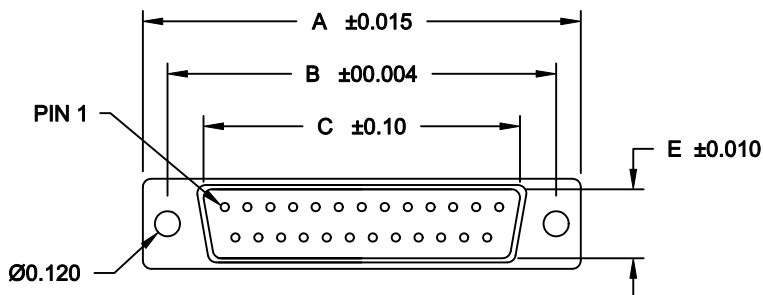

671-YYY-113RYY1

SERIES _____
 POSITIONS _____
 009
 015
 025
 GENDER _____
 1 = MALE
 TERMINATION _____
 1 = DIP SOLDER
 SHELL PLATING _____
 3 = NICKEL
 HARDWARE OPTIONS _____
 00 = NO HARDWARE
 01 = .098 4-40 CLINCH NUT BOARD SIDE
 02 = .236 4-40 CLINCH NUT BOARD SIDE
 03 = .236 4-40 CLINCH NUT MATING SIDE
 05 = .237 4-40 BOARD LOCK
 PLATING OPTIONS _____
 1 = GOLD FLASH
 2 = 30 MICRO-INCH GOLD

MEETS IP66 STANDARDS

(SEE PAGE 2FOR SEALING DETAILS)

DO NOT SCALE FROM DRAWING



THESE DRAWINGS AND SPECIFICATIONS ARE THE PROPERTY OF NorComp AND SHALL NOT BE REPRODUCED, COPIED OR USED AS THE BASIS FOR THE MANUFACTURE OF SALE OF APPARATUS WITHOUT WRITTEN PERMISSION.

DRAWN:
P. JENKINS

DATE:
11-24-11

CHECKED:

DATE:

SCALE:

SHEET OF REV
1 OF **3** **0**

DWG NO.

671-YYY-113RYY1

NorComp

RoHS COMPLIANT

DESCRIPTION: PCB LAYOUT - STANDARD "D" - MALE & FEMALE

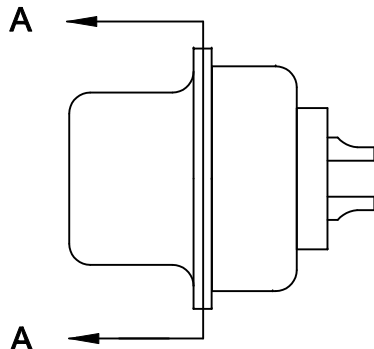

FRONT SEAL APPLIED OVER INSULATOR AND BETWEEN FRONT & REAR SHELLS

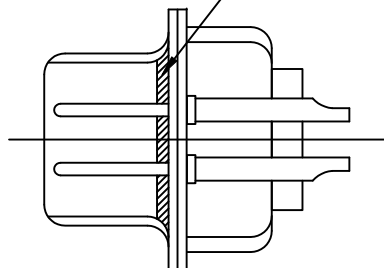

DETAIL A-A

SHOWN FOR REFERENCE ONLY

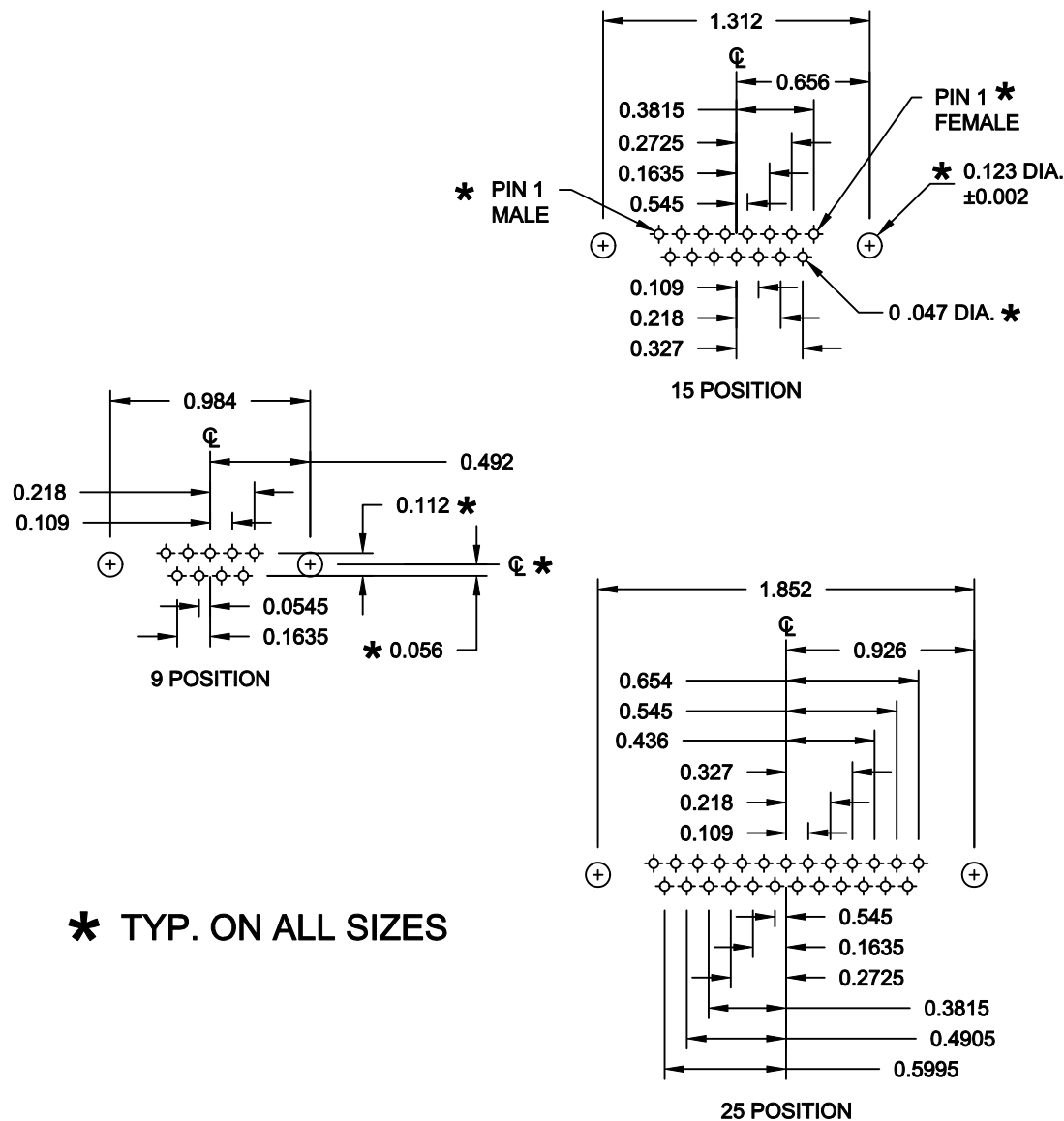

* TYP. ON ALL SIZES

DO NOT SCALE FROM DRAWING



THESE DRAWINGS AND SPECIFICATIONS ARE THE PROPERTY OF NorComp AND SHALL NOT BE REPRODUCED, COPIED OR USED AS THE BASIS FOR THE MANUFACTURE OF SALE OF APPARATUS WITHOUT WRITTEN PERMISSION.

DRAWN: P. JENKINS DATE: 11-24-11

CHECKED: DATE:

NorComp

SCALE: FULL SHEET 2 OF 3 REV 0

DWG NO. 671-YYY-113RYY1

DESCRIPTION: CLINCH NUT HARDWARE

TOLERANCE:
ALL DIMENSIONS ARE ± 0.010

ALL CLINCH-NUTS ARE 4-40 INTERNAL THREADS

01X 0.098" (BOARD SIDE) - CN1

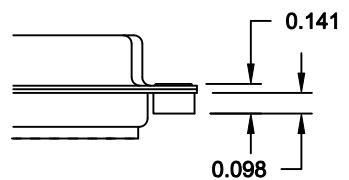

02X 0.236" (BOARD SIDE) - CN2

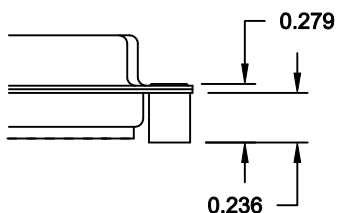

03X..... 0.236" (MATING SIDE) - CN8

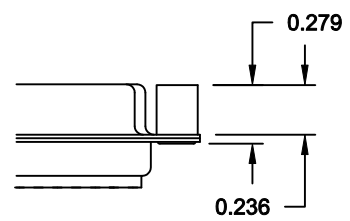

05X 0.237" (BOARD SIDE) - CN10

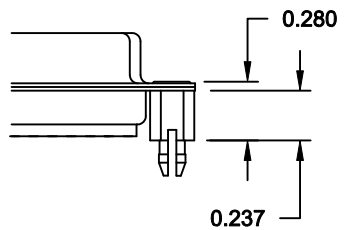

DO NOT SCALE FROM DRAWING

	THESE DRAWINGS AND SPECIFICATIONS ARE THE PROPERTY OF NorComp AND SHALL NOT BE REPRODUCED, COPIED OR USED AS THE BASIS FOR THE MANUFACTURE OF SALE OF APPARATUS WITHOUT WRITTEN PERMISSION.		DRAWN: P. JENKINS	DATE: 11-24-11
			CHECKED:	DATE:
<h1>NorComp</h1>		SCALE:	SHEET 3 OF 3	REV 0
		DWG NO. 671-YYY-113RYY1		

RoHS COMPLIANT

Mouser Electronics

Authorized Distributor

Click to View Pricing, Inventory, Delivery & Lifecycle Information:

NorComp:

[671-009-103L001](#) [671-009-103L011](#) [671-009-103L021](#) [671-009-103L031](#) [671-009-113R001](#) [671-009-113R011](#)
[671-009-113R021](#) [671-009-113R031](#) [671-009-113R051](#) [671-015-103L001](#) [671-015-103L011](#) [671-015-103L021](#) [671-](#)
[015-103L031](#) [671-015-113R001](#) [671-015-113R011](#) [671-015-113R021](#) [671-015-113R031](#) [671-015-113R051](#) [671-](#)
[025-103L001](#) [671-025-103L011](#) [671-025-103L021](#) [671-025-103L031](#) [671-025-113R001](#) [671-025-113R011](#) [671-025-](#)
[113R021](#) [671-025-113R031](#) [671-025-113R051](#)