

**NOT RECOMMENDED FOR NEW DESIGNS
POSSIBLE SUBSTITUTE PRODUCTS
(ISL55002, ISL55004)**

Dual/Quad Low-Power 120MHz Unity-Gain Stable Op Amp

The EL2244 and EL2444 are dual and quad versions of the popular EL2044. They are high speed, low power, low cost monolithic operational amplifiers built on Elantec's proprietary complementary bipolar process. The EL2244 and EL2444 are unity-gain stable and feature a 325V/ μ s slew rate and 120MHz gain-bandwidth product while requiring only 5.2mA of supply current per amplifier.

The power supply operating range of the EL2244 and EL2444 is from $\pm 18V$ down to as little as $\pm 2V$. For single-supply operation, the EL2244 and EL2444 operate from 36V down to as little as 2.5V. The excellent power supply operating range of the EL2244 and EL2444 makes them an obvious choice for applications on a single +5V or +3V supply.

The EL2244 and EL2444 also feature an extremely wide output voltage swing of $\pm 13.6V$ with $V_S = \pm 15V$ and $R_L = 1k\Omega$. At $\pm 5V$, output voltage swing is a wide $\pm 3.8V$ with $R_L = 500\Omega$ and $\pm 3.2V$ with $R_L = 150\Omega$. Furthermore, for single-supply operation at +5V, output voltage swing is an excellent 0.3V to 3.8V with $R_L = 500\Omega$.

At a gain of +1, the EL2244 and EL2444 have a -3dB bandwidth of 120MHz with a phase margin of 50°. Because of their conventional voltage-feedback topology, the EL2244 and EL2444 allow the use of reactive or non-linear elements in their feedback network. This versatility combined with low cost and 75mA of output-current drive make the EL2244 and EL2444 an ideal choice for price-sensitive applications requiring low power and high speed.

Features

- 120MHz gain-bandwidth product
- Unity-gain stable
- Low supply current (per amplifier) - 5.2mA at $V_S = \pm 15V$
- Wide supply range - 2.5V to 36V
- High slew rate - 325V/ μ s
- Fast settling - 80ns to 0.1% for a 10V step
- Low differential gain - 0.04% at $A_V = +2$, $R_L = 150\Omega$
- Low differential phase - 0.15° at $A_V = +2$, $R_L = 150\Omega$
- Wide output voltage swing - $\pm 13.6V$ with $V_S = \pm 15V$, $R_L = 1k\Omega$
- Low cost, enhanced replacement for the AD827 & LT1229/LT1230
- Pb-Free available (RoHS compliant)

Applications

- Video amplifiers
- Single-supply amplifiers
- Active filters/integrators
- High speed signal processing
- ADC/DAC buffers
- Pulse/RF amplifiers
- Pin diode receivers
- Log amplifiers

Pinouts

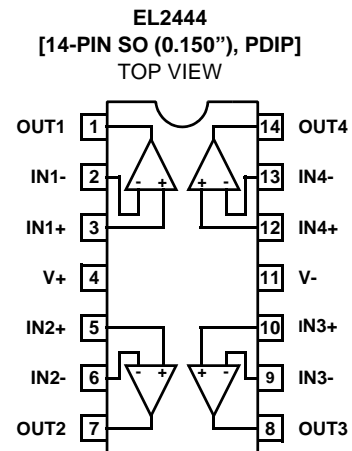
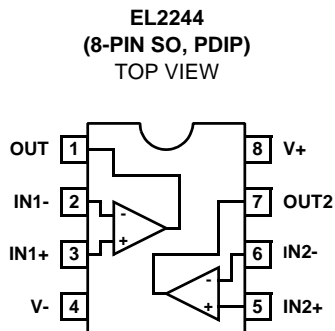

Ordering Information

PART NUMBER	PACKAGE	TAPE & REEL	PKG. DWG. #
EL2244CM	16-Pin SO (0.300")	-	MDP0027
EL2244CM-T13	16-Pin SO (0.300")	13"	MDP0027
EL2244CMZ (See Note)	16-Pin SO (0.300") (Pb-free)	-	MDP0027
EL2244CMZ-T13 (See Note)	16-Pin SO (0.300") (Pb-free)	13"	MDP0027
EL2244CN	8-Pin PDIP	-	MDP0031
EL2244CS	8-Pin SO	-	MDP0027
EL2244CS-T7	8-Pin SO	7"	MDP0027
EL2244CS-T13	8-Pin SO	13"	MDP0027
EL2244CSZ (See Note)	8-Pin SO (Pb-free)	-	MDP0027
EL2244CSZ-T7 (See Note)	8-Pin SO (Pb-free)	7"	MDP0027
EL2244CSZ-T13 (See Note)	8-Pin SO (Pb-free)	13"	MDP0027
EL2444CN	14-Pin PDIP	-	MDP0031
EL2444CS	14-Pin SO (0.150")	-	MDP0027
EL2444CS-T7	14-Pin SO (0.150")	7"	MDP0027
EL2444CS-T13	14-Pin SO (0.150")	13"	MDP0027
EL2444CSZ (See Note)	14-Pin SO (0.150") (Pb-free)	-	MDP0027
EL2444CSZ-T7 (See Note)	14-Pin SO (0.150") (Pb-free)	7"	MDP0027
EL2444CSZ-T13 (See Note)	14-Pin SO (0.150") (Pb-free)	13"	MDP0027

NOTE: Intersil Pb-free products employ special Pb-free material sets; molding compounds/die attach materials and 100% matte tin plate termination finish, which are RoHS compliant and compatible with both SnPb and Pb-free soldering operations. Intersil Pb-free products are MSL classified at Pb-free peak reflow temperatures that meet or exceed the Pb-free requirements of IPC/JEDEC J STD-020.

EL2244, EL2444

Absolute Maximum Ratings (T_A = 25°C)

Supply Voltage (V _S) ±18V or 36V	Power Dissipation (P _D) See Curves
Input Voltage (V _{IN}) ±V _S	Operating Temperature Range (T _A) -40°C to +85°C
Differential Input Voltage (dV _{IN}) ±10V	Operating Junction Temperature (T _J) +150°C
Continuous Output Current 40mA	Storage Temperature (T _{ST}) -65°C to +150°C

CAUTION: Stresses above those listed in "Absolute Maximum Ratings" may cause permanent damage to the device. This is a stress only rating and operation of the device at these or any other conditions above those indicated in the operational sections of this specification is not implied.

IMPORTANT NOTE: All parameters having Min/Max specifications are guaranteed. Typical values are for information purposes only. Unless otherwise noted, all tests are at the specified temperature and are pulsed tests, therefore: T_J = T_C = T_A

DC Electrical Specifications V_S = ±15V, R_L = 1kΩ, unless otherwise specified.

PARAMETER	DESCRIPTION	CONDITION	TEMP	MIN	TYP	MAX	UNIT
V _{OS}	Input Offset Voltage	V _S = ±15V	25°C		0.5	4.0	mV
			T _{MIN} , T _{MAX}			9.0	mV
TCV _{OS}	Average Offset Voltage Drift	(Note 1)	All		10.0		µV/°C
I _B	Input Bias Current	V _S = ±15V	25°C		2.8	8.2	µA
			T _{MIN} , T _{MAX}			11.2	µA
		V _S = ±5V	25°C		2.8		µA
I _{OS}	Input Offset Current	V _S = ±15V	25°C		50	300	nA
			T _{MIN} , T _{MAX}			500	nA
		V _S = ±5V	25°C		50		nA
TCI _{OS}	Average Offset Current Drift	(Note 1)	All		0.3		nA/°C
A _{VOL}	Open-Loop Gain	V _S = ±15V, V _{OUT} = ±10V, R _L = 1kΩ	25°C	800	1500		V/V
			T _{MIN} , T _{MAX}	600			V/V
		V _S = ±5V, V _{OUT} = ±2.5V, R _L = 500Ω	25°C		1200		V/V
		V _S = ±5V, V _{OUT} = ±2.5V, R _L = 150Ω	25°C		1000		V/V
PSRR	Power Supply Rejection Ratio	V _S = ±5V to ±15V	25°C	65	80		dB
			T _{MIN} , T _{MAX}	60			dB
CMRR	Common-mode Rejection Ratio	V _{CM} = ±12V, V _{OUT} = 0V	25°C	70	90		dB
			T _{MIN} , T _{MAX}	70			dB
CMIR	Common-mode Input Range	V _S = ±15V	25°C		±14.0		V
		V _S = ±5V	25°C		±4.2		V
		V _S = +5V	25°C		4.2/0.1		V
V _{OUT}	Output Voltage Swing	V _S = ±15V, R _L = 1kΩ	25°C	±13.4	±13.6		V
			T _{MIN} , T _{MAX}	±13.1			V
		V _S = ±15V, R _L = 500Ω	25°C	±12.0	±13.4		V
		V _S = ±5V, R _L = 500Ω	25°C	±3.4	±3.8		V
		V _S = ±5V, R _L = 150Ω	25°C		±3.2		V
		V _S = +5V, R _L = 500Ω	25°C	3.6/0.4	3.8/0.3		V
		T _{MIN} , T _{MAX}	3.5/0.5			V	
I _{SC}	Output Short Circuit Current		25°C	40	75		mA
			T _{MIN} , T _{MAX}	35			mA

EL2244, EL2444

DC Electrical Specifications $V_S = \pm 15V$, $R_L = 1k\Omega$, unless otherwise specified. (Continued)

PARAMETER	DESCRIPTION	CONDITION	TEMP	MIN	TYP	MAX	UNIT
I _S	Supply Current (per amplifier)	$V_S = \pm 15V$, no load	25°C		5.2	7	mA
			T _{MIN}			7.6	mA
			T _{MAX}			7.6	mA
		$V_S = \pm 5V$, no load	25°C		5.0		mA
R _{IN}	Input Resistance	Differential	25°C		150		k Ω
		Common-mode	25°C		15		M Ω
C _{IN}	Input Capacitance	$A_V = +1$ @10MHz	25°C		1.0		pF
R _{OUT}	Output Resistance	$A_V = +1$	25°C		50		m Ω
PSOR	Power-Supply Operating Range	Dual-supply	25°C	± 2.0		± 18.0	V
		Single-supply	25°C	2.5		36.0	V

NOTE:

1. Measured from T_{MIN} to T_{MAX}.

Closed-Loop AC Electrical Specifications $V_S = \pm 15V$, $A_V = +1$, $R_L = 1k\Omega$, unless otherwise specified.

PARAMETER	DESCRIPTION	CONDITION	TEMP	MIN	TYP	MAX	UNIT
BW	-3dB Bandwidth ($V_{OUT} = 0.4V_{PP}$)	$V_S = \pm 15V$, $A_V = +1$	25°C		120		MHz
		$V_S = \pm 15V$, $A_V = -1$	25°C		60		MHz
		$V_S = \pm 15V$, $A_V = +2$	25°C		60		MHz
		$V_S = \pm 15V$, $A_V = +5$	25°C		12		MHz
		$V_S = \pm 15V$, $A_V = +10$	25°C		6		MHz
		$V_S = \pm 5V$, $A_V = +1$	25°C		80		MHz
GBWP	Gain-Bandwidth Product	$V_S = \pm 15V$	25°C		60		MHz
		$V_S = \pm 5V$	25°C		45		MHz
PM	Phase Margin	$R_L = 1k\Omega$, $C_L = 10pF$	25°C		50		°
CS	Channel Separation	$f = 5MHz$	25°C		85		dB
SR	Slew Rate (Note 1)	$V_S = \pm 15V$, $R_L = 1k\Omega$	25°C	250	325		V/ μs
		$V_S = \pm 5V$, $R_L = 500\Omega$	25°C		200		V/ μs
FPBW	Full-Power Bandwidth (Note 2)	$V_S = \pm 15V$	25°C	4.0	5.2		MHz
		$V_S = \pm 5V$	25°C		12.7		MHz
t _R , t _F	Rise Time, Fall Time	0.1V step	25°C		3.0		ns
OS	Overshoot	0.1V step	25°C		20		%
t _{PD}	Propagation Delay		25°C		2.5		ns
t _S	Settling to +0.1% ($A_V = +1$)	$V_S = \pm 15V$, 10V step	25°C		80		ns
		$V_S = \pm 5V$, 5V step	25°C		60		ns
dG	Differential Gain (Note 3)	NTSC/PAL	25°C		0.04		%
dP	Differential Phase (Note 3)	NTSC/PAL	25°C		0.15		°
eN	Input Noise Voltage	10kHz	25°C		15.0		nV/ \sqrt{Hz}
iN	Input Noise Current	10kHz	25°C		1.50		pA/ \sqrt{Hz}

NOTES:

1. Slew rate is measured on rising edge
2. For $V_S = \pm 15V$, $V_{OUT} = 20V_{PP}$. For $V_S = \pm 5V$, $V_{OUT} = 5V_{PP}$. Full-power bandwidth is based on slew rate measurement using: $FPBW = SR / (2\pi * V_{peak})$.
3. Video performance measured at $V_S = \pm 15V$, $A_V = +2$ with 2 times normal video level across $R_L = 150\Omega$. This corresponds to standard video levels across a back-terminated 75 Ω load. For other values of R_L , see curves.

Typical Performance Curves

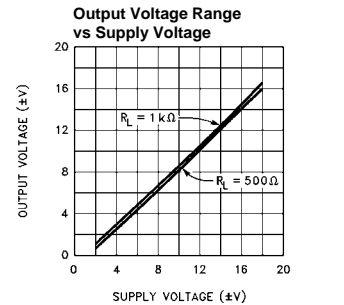
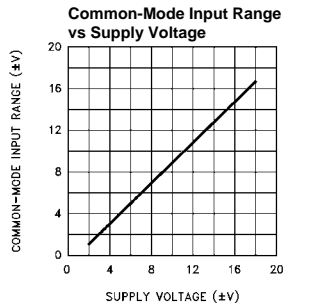
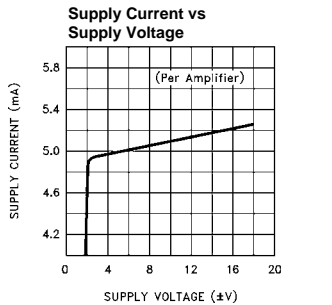
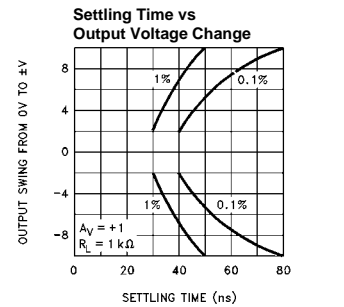
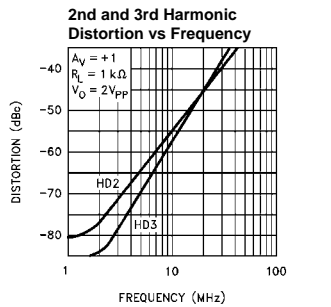
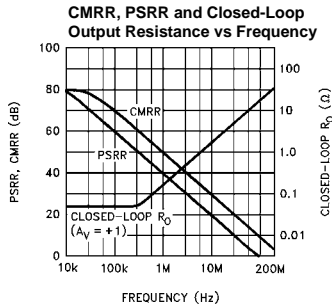
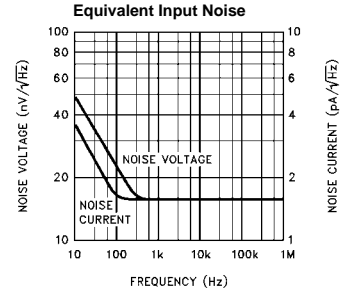
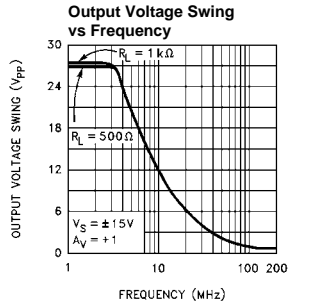
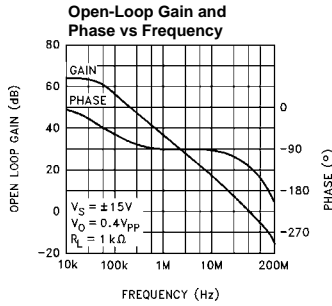
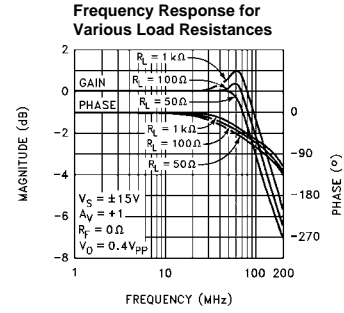
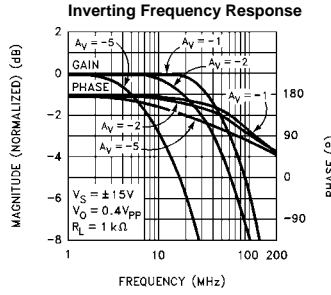
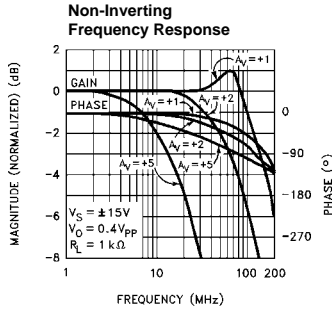

Typical Performance Curves (Continued)

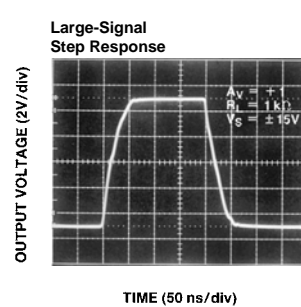
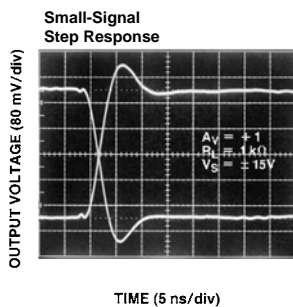
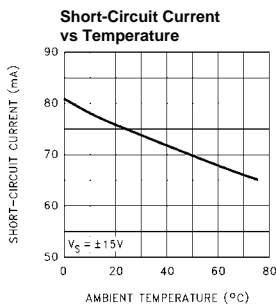
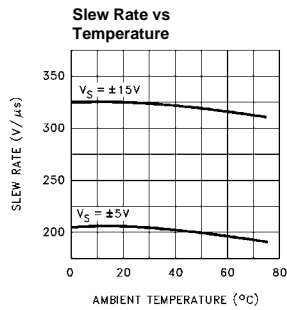
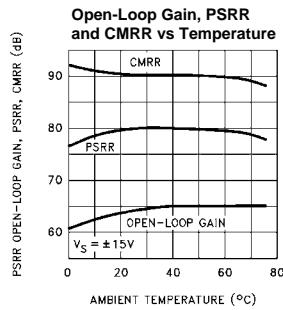
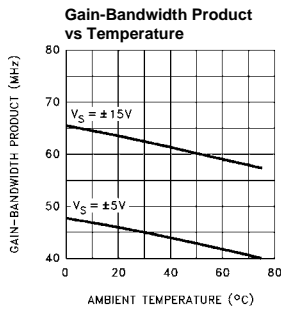
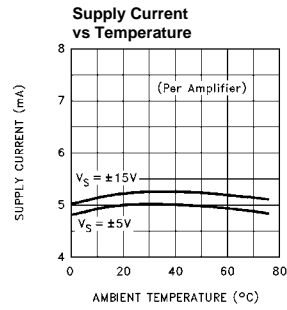
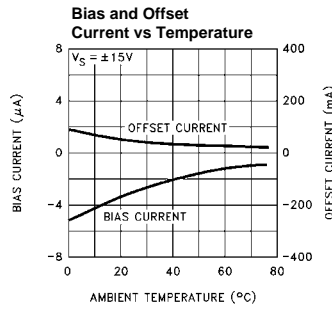
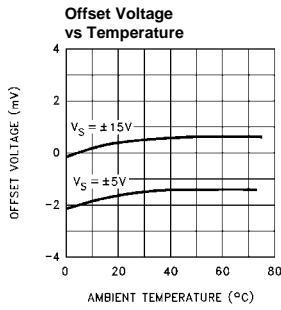
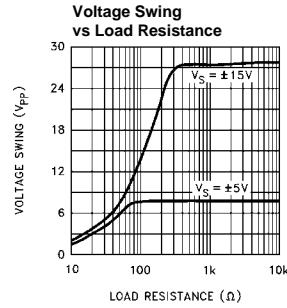
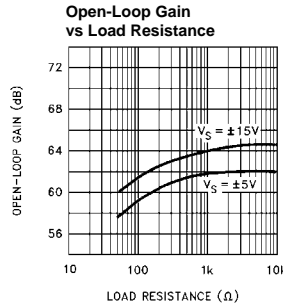
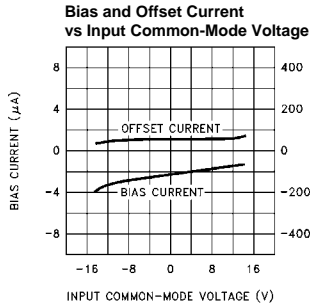
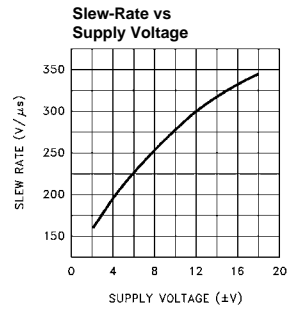
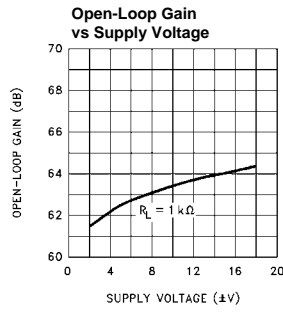
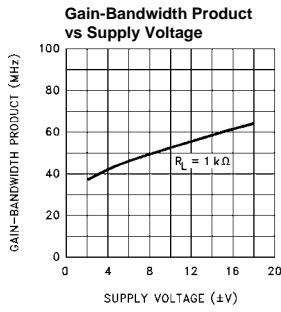

Typical Performance Curves (Continued)

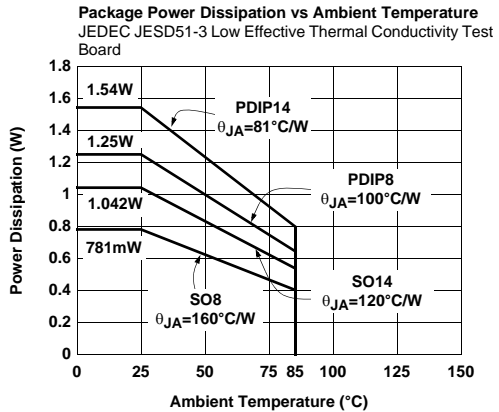
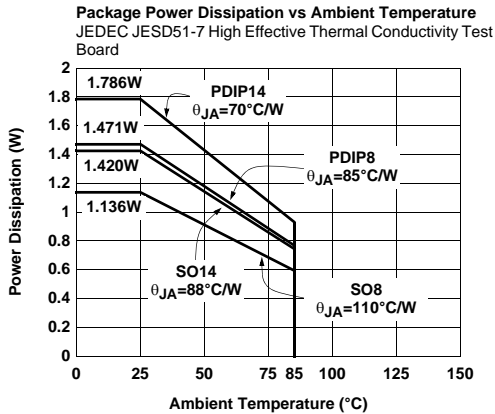
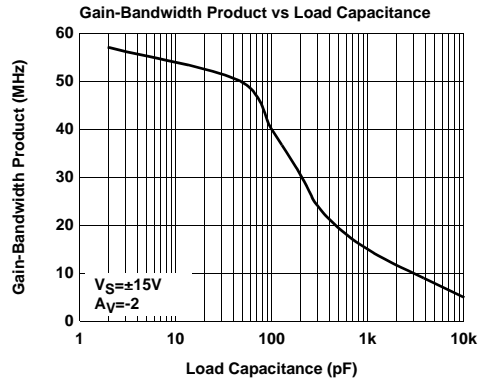
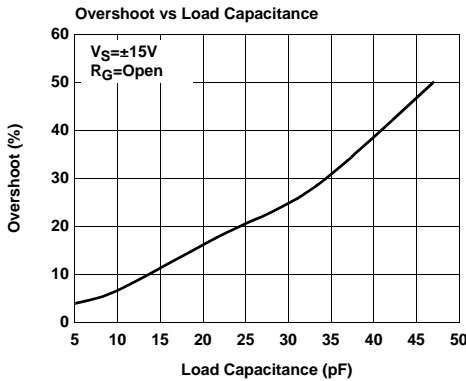
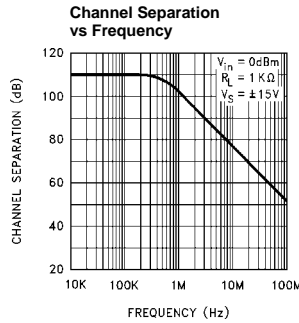
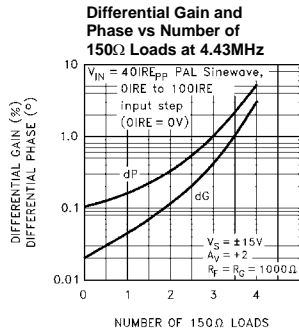
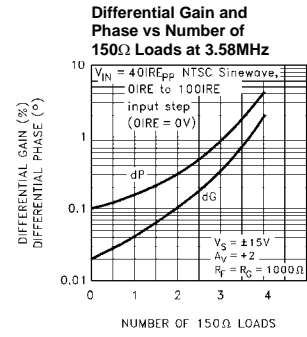
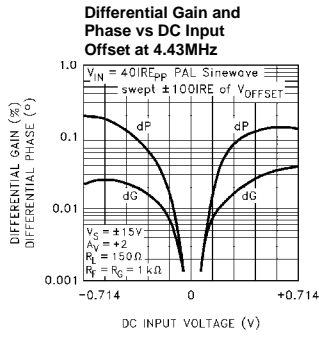
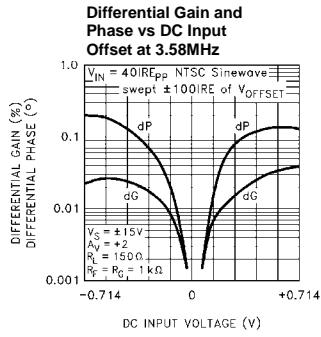

Simplified Schematic (Per Amplifier)

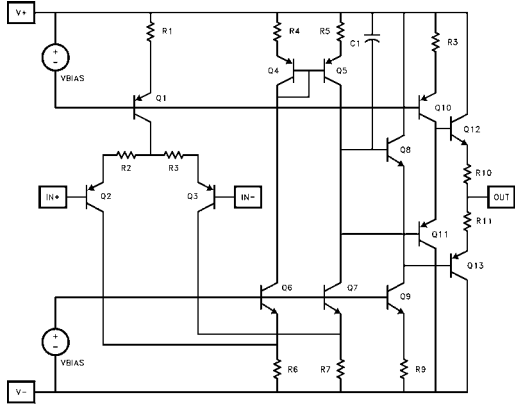

Burn-In Circuit (Per Amplifier)

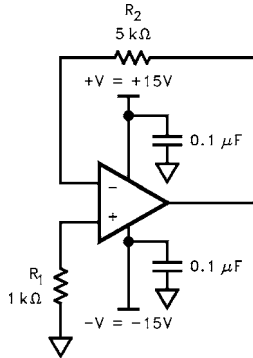

ALL PACKAGES USE THE SAME SCHEMATIC

Applications Information

Product Description

The EL2244 and EL2444 are low-power wideband monolithic operational amplifiers built on Elantec's proprietary high-speed complementary bipolar process. The EL2244 and EL2444 use a classical voltage-feedback topology which allows them to be used in a variety of applications where current-feedback amplifiers are not appropriate because of restrictions placed upon the feedback element used with the amplifier. The conventional topology of the EL2244 and EL2444 allows, for example, a capacitor to be placed in the feedback path, making it an excellent choice for applications such as active filters, sample-and-holds, or integrators. Similarly, because of the ability to use diodes in the feedback network, the EL2244 and EL2444 are an excellent choice for applications such as fast log amplifiers.

Power Dissipation

With the wide power supply range and large output drive capability of the EL2244 and EL2444, it is possible to exceed the 150°C maximum junction temperatures under certain load and power-supply conditions. It is therefore important to

calculate the maximum junction temperature (T_{JMAX}) for all applications to determine if power supply voltages, load conditions, or package type need to be modified for the EL2244 and EL2444 to remain in the safe operating area. These parameters are related as follows:

$$T_{JMAX} = T_{MAX} + (\theta_{JA} \times PD_{MAXTOTAL})$$

where:

$PD_{MAXTOTAL}$ is the sum of the maximum power dissipation of each amplifier in the package (PD_{MAX}). PD_{MAX} for each amplifier can be calculated as follows:

$$PD_{MAX} = 2 \times V_S \times I_{SMAX} + (V_S - V_{OUTMAX}) \times \frac{V_{OUTMAX}}{R_L}$$

where:

- T_{MAX} = Maximum ambient temperature
- θ_{JA} = Thermal resistance of the package
- PD_{MAX} = Maximum power dissipation of each amplifier
- V_S = Supply voltage
- I_{SMAX} = Maximum supply current of each amplifier
- V_{OUTMAX} = Maximum output voltage swing of the application
- R_L = Load resistance

To serve as a guide for the user, we can calculate maximum allowable supply voltages for the example of the video cable-driver below since we know that $T_{JMAX} = 150^\circ\text{C}$, $T_{MAX} = 85^\circ\text{C}$, $I_{SMAX} = 7.6\text{mA}$ per amplifier, and the package θ_{JA} s are shown in Table 1. If we assume (for this example) that we are driving a back-terminated video cable, then the maximum average value (over duty-cycle) of V_{OUTMAX} is 1.4V, and $R_L = 150\Omega$, giving the results seen in Table 1.

TABLE 1.

PART	PACKAGE	θ_{JA}	MAX PDISS @ T_{MAX}	MAX V_S
DUALS				
EL2244CN	PDIP8	100°C/W	0.650W @ 85°C	±16.6V
EL2244CS	SO8	160°C/W	0.406W @ 85°C	±10.5V
QUADS				
EL2444CN	PDIP14	81°C/W	0.802W @ 85°C	±11.5V
EL2444CS	SO14	120°C/W	0.542W @ 85°C	±7.5V

Single-Supply Operation

The EL2244 and EL2444 have been designed to have a wide input and output voltage range. This design also makes the EL2244 and EL2444 an excellent choice for single-supply operation. Using a single positive supply, the lower

input voltage range is within 100mV of ground ($R_L = 500\Omega$), and the lower output voltage range is within 300mV of ground. Upper input voltage range reaches 4.2V, and output voltage range reaches 3.8V with a 5V supply and $R_L = 500\Omega$. This results in a 3.5V output swing on a single 5V supply. This wide output voltage range also allows single-supply operation with a supply voltage as high as 36V or as low as 2.5V. On a single 2.5V supply, the EL2244 and EL2444 still have 1V of output swing.

Gain-Bandwidth Product and the -3dB Bandwidth

The EL2244 and EL2444 have a gain-bandwidth product of 120MHz while using only 5.2mA of supply current per amplifier. For gains greater than 4, their closed-loop -3dB bandwidth is approximately equal to the gain-bandwidth product divided by the noise gain of the circuit. For gains less than 4, higher-order poles in the amplifiers' transfer function contribute to even higher closed loop bandwidths. For example, the EL2244 and EL2444 have a -3dB bandwidth of 120MHz at a gain of +1, dropping to 60MHz at a gain of +2. It is important to note that the EL2244 and EL2444 have been designed so that this "extra" bandwidth in low-gain applications does not come at the expense of stability. As seen in the typical performance curves, the EL2244 and EL2444 in a gain of +1 only exhibit 1.0dB of peaking with a 1k Ω load.

Video Performance

An industry-standard method of measuring the video distortion of components such as the EL2244 and EL2444 is to measure the amount of differential gain (dG) and differential phase (dP) that they introduce. To make these measurements, a 0.286V_{PP} (40 IRE) signal is applied to the device with 0V DC offset (0 IRE) at either 3.58MHz for NTSC or 4.43MHz for PAL. A second measurement is then made at 0.714V DC offset (100 IRE). Differential gain is a measure of the change in amplitude of the sine wave, and is measured in percent. Differential phase is a measure of the change in phase, and is measured in degrees.

For signal transmission and distribution, a back-terminated cable (75 Ω in series at the drive end, and 75 Ω to ground at the receiving end) is preferred since the impedance match at both ends will absorb any reflections. However, when double termination is used, the received signal is halved; therefore a gain of 2 configuration is typically used to compensate for the attenuation.

The EL2244 and EL2444 have been designed as an economical solution for applications requiring low video distortion. They have been thoroughly characterized for video performance in the topology described above, and the results have been included as typical dG and dP specifications and as typical performance curves. In a gain of +2, driving 150 Ω , with standard video test levels at the input, the EL2244 and EL2444 exhibit dG and dP of only 0.04% and 0.15° at NTSC and PAL. Because dG and dP

can vary with different DC offsets, the video performance of the EL2244 and EL2444 has been characterized over the entire DC offset range from -0.714V to +0.714V. For more information, refer to the curves of dG and dP vs DC Input Offset.

Output Drive Capability

The EL2244 and EL2444 have been designed to drive low impedance loads. They can easily drive 6V_{PP} into a 150 Ω load. This high output drive capability makes the EL2244 and EL2444 an ideal choice for RF, IF and video applications. Furthermore, the current drive of the EL2244 and EL2444 remains a minimum of 35mA at low temperatures.

Printed-Circuit Layout

The EL2244 and EL2444 are well behaved, and easy to apply in most applications. However, a few simple techniques will help assure rapid, high quality results. As with any high-frequency device, good PCB layout is necessary for optimum performance. Ground-plane construction is highly recommended, as is good power supply bypassing. A 0.1 μ F ceramic capacitor is recommended for bypassing both supplies. Lead lengths should be as short as possible, and bypass capacitors should be as close to the device pins as possible. For good AC performance, parasitic capacitances should be kept to a minimum at both inputs and at the output. Resistor values should be kept under 5k Ω because of the RC time constants associated with the parasitic capacitance. Metal-film and carbon resistors are both acceptable, use of wire-wound resistors is not recommended because of their parasitic inductance. Similarly, capacitors should be low-inductance for best performance.

The EL2244 and EL2444 Macromodel

This macromodel has been developed to assist the user in simulating the EL2244 and EL2444 with surrounding circuitry. It has been developed for the PSPICE simulator (copyrighted by the Microsim Corporation), and may need to be rearranged for other simulators. It approximates DC, AC, and transient response for resistive loads, but does not accurately model capacitive loading. This model is slightly more complicated than the models used for low-frequency op-amps, but it is much more accurate for AC analysis.

The model does not simulate these characteristics accurately:

- Noise
- Settling time
- Non-linearities
- Temperature effects
- Manufacturing variations
- CMRR
- PSRR

EL2244 and EL244C Macromodel

```

* Connections: +input
*
*      |   -input
*      |   |   +Vsupply
*      |   |   -Vsupply
*      |   |   |   output
*      |   |   |   |
.subckt M2244 3 2 7 4 6
*
* Input stage
*
ie 7 37 1mA
r6 36 37 800
r7 38 37 800
rc1 4 30 850
rc2 4 39 850
q1 30 3 36 qp
q2 39 2 38 qpa
ediff 33 0 39 30 1.0
rdiff 33 0 1Meg
*
* Compensation Section
*
ga 0 34 33 0 1m
rh 34 0 2Meg
ch 34 0 1.3pF
rc 34 40 1K
cc 40 0 1pF
*
* Poles
*
ep 41 0 40 0 1
rpa 41 42 200
cpa 42 0 1pF
rpb 42 43 200
cpb 43 0 1pF
*
* Output Stage
*
ios1 7 50 1.0mA
ios2 51 4 1.0mA
q3 4 43 50 qp
q4 7 43 51 qn
q5 7 50 52 qn
q6 4 51 53 qp
ros1 52 6 25
ros2 6 53 25
*
* Power Supply Current
*
ips 7 4 2.7mA
*
* Models
*
.model qn npn(is=800E-18 bf=200 tf=0.2nS)
.model qpa pnp(is=864E-18 bf=100 tf=0.2nS)
.model qp pnp(is=800E-18 bf=125 tf=0.2nS)
.ends

```

EL2244 and EL2444 Macromodel (Continued)

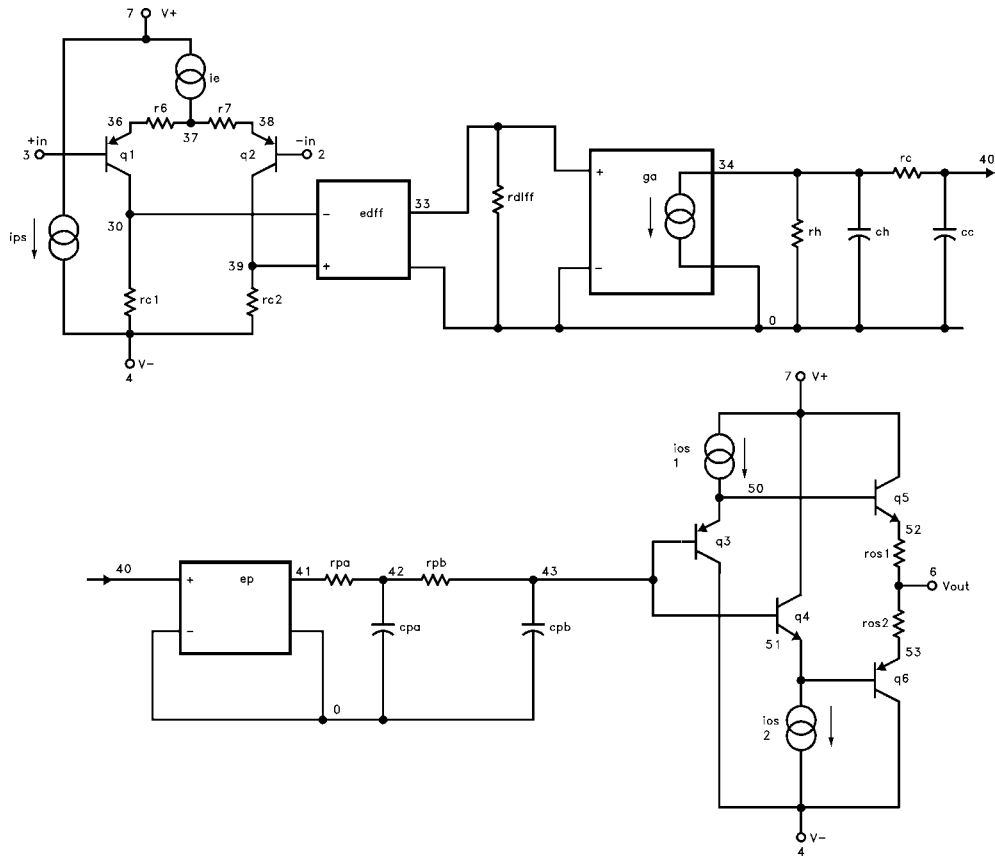

All Intersil U.S. products are manufactured, assembled and tested utilizing ISO9000 quality systems.
Intersil Corporation's quality certifications can be viewed at www.intersil.com/design/quality

Intersil products are sold by description only. Intersil Corporation reserves the right to make changes in circuit design, software and/or specifications at any time without notice. Accordingly, the reader is cautioned to verify that data sheets are current before placing orders. Information furnished by Intersil is believed to be accurate and reliable. However, no responsibility is assumed by Intersil or its subsidiaries for its use; nor for any infringements of patents or other rights of third parties which may result from its use. No license is granted by implication or otherwise under any patent or patent rights of Intersil or its subsidiaries.

For information regarding Intersil Corporation and its products, see www.intersil.com