

# FPC-7700

## Robust Box PC with Intel® Sandy Bridge / Ivy Bridge Platform



### Features

- **Fanless Design**
- Wide Range DC Power Input (9 ~36V)
- Support iAMT Function
- Support Various Video Interfaces (DVI-I + DVI-D)
- Support Optional WiFi or HSUPA Wireless Connectivity
- Rugged Design for Shock/Vibration Protection
- Memory Support up to 16GB (DDR3)
- Intel® SSD compatible

<b>System</b>	
<b>CPU</b>	Support Intel® 2nd & 3rd generation Core™ i7/i5/i3 or Celeron® processors in rPGA988 socket
<b>Memory</b>	2 x 204-pin DDR3 SO-DIMM sockets, supporting 1333/1600MHz SDRAM up to 16GB
<b>Chipset</b>	Intel® QM77
<b>Graphics</b>	Integrated Intel® HD 4000
<b>ATA</b>	2 x Serial ATA ports with RAID 0/1 support 2 x eSATA
<b>LAN Chipset</b>	2 x Intel® WG82583V GbE controllers 1 x Intel® WG82579LM GbE PHY w/ iAMT
<b>Watchdog Timer</b>	1~255 levels reset
<b>I/O</b>	
	1 x DB-44 female connector
<b>Serial Port</b>	COM1/2 are RS-232 COM3/4 are RS-232/422/485 selectable, w/ 2.5kv isolation protection
<b>USB Port</b>	6 x USB 2.0 ports, 4 x USB 3.0/ 2.0 ports
<b>LAN</b>	3 x RJ-45 ports for GbE
<b>Video Port</b>	1 x DVI-I female connector for Digital/ Analog Video output 1 x DVI-D female connector for Digital Video output
<b>Selectable Port</b>	1 x DB25 connector for 1 x DIO (8 in/8 out) port or 1 x LPT port (either one) DIO by default, can be changed to LPT
<b>Audio</b>	Mic-in/Line-out
<b>Expansion Bus</b>	1 x Mini-card slot interconnected with SIM card socket for optional WiFi or HSUPA module 1 x SIM socket/1 x CFAST socket (outside accessible)
<b>Environmental</b>	
<b>Operating Temp.</b>	-20 ~ 55°C (-4 ~ 131°F), ambient w/ air flow
<b>Storage Temp.</b>	-40 ~ 85°C (-40 ~ 185°F)
<b>Operating Humidity</b>	10 ~ 95% @ 55°C (non-condensing)
<b>Vibration</b>	3 Grms/5~500Hz/random operation w/ SSD

<b>Shock</b>	Operating 40G (11ms), Non-operating 60G with SSD Crash 100G, 11ms
--------------	--

### Qualification

<b>Certification</b>	CE, FCC Class A
----------------------	-----------------

### Power Requirement

<b>Power Input</b>	DC 9~36V input w/ 4-pin terminal block
<b>Power Consumption</b>	3.51A/19V, 67W (i7-3610QE)

### Storage

<b>Type</b>	2 x 2.5" drive bays 1 x CFAST socket
-------------	---

### Mechanical

<b>Construction</b>	Aluminum alloy
<b>Mounting</b>	Support wall-mounting
<b>Weight</b>	6.4 kg (14.1 lb)
<b>Dimensions (W x D x H)</b>	225 x 267 x 90 mm

### OS Support

Windows XP Professional / Windows Embedded Professional 7 / Windows Embedded Standard 7

### Ordering Information

<b>FPC-7700</b>	Fanless system w/o expansion
-----------------	------------------------------





» Fanless Design

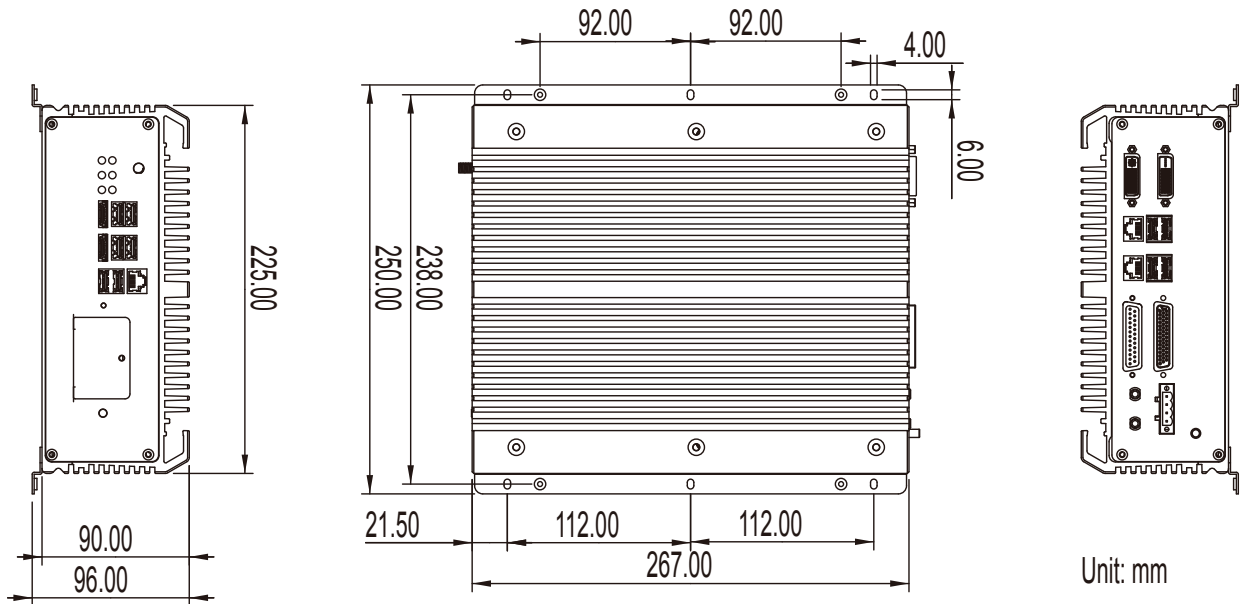





## Dimensions



## Optional Accessories

<b>PAC-B120W-FSP</b>	19V/6.32A 120W AC/DC adapter kit	
<b>CBL-7100-COM</b>	4 x COM ports converter cable	
<b>WMK-7000</b>	Wall-mount kit for FPC-7XXX Series	

## Optional Configuration (CTOS\* Kit)

<b>SSD-25040</b>	Intel® 2.5" 40GB SATAII SSD kit	
<b>HSPA-SI1400</b>	HSUPA 3.75G module kit & internal wiring	
<b>WIFI-IN1300</b>	Intel® Centrino® Advanced-N 6205 WiFi module w/ 20cm internal wiring	
<b>ANT-H11</b>	1 x 2dBi HSUPA antenna	
<b>ANT-D11</b>	1 x WiFi Dual-band 2.4G/5G antenna	
<b>Core™ i3-3120ME</b>	Intel® 3rd Gen. Core™ i3-3120ME processor, L2/3M, 2.4G	
<b>Core™ i5-3610ME</b>	Intel® 3rd Gen. Core™ i5-3610ME processor, L2/3M, 2.7G	
<b>Core™ i7-3610QE</b>	Intel® 3rd Gen. Core™ i7-3610QE processor, L2/6M, 2.3G	
<b>MK-3C-4G-1</b>	DDR3-1333 4GB SDRAM DIMM1 kit	
<b>MK-3C-4G-2</b>	DDR3-1333 4GB SDRAM DIMM2 kit	
<b>MK-3C-8G-1</b>	DDR3-1600 8GB SDRAM DIMM1 kit	
<b>MK-3C-8G-2</b>	DDR3-1600 8GB SDRAM DIMM2 kit	

\*CTOS means Configure to Order Service.

# Mouser Electronics

Authorized Distributor

Click to View Pricing, Inventory, Delivery & Lifecycle Information:

[ARBOR Technology:](#)

[FPC-7700](#)