

THIS DOCUMENT IS THE PROPERTY OF
KEYSTONE ELECTRONICS CORP. AND
SHALL NOT BE REPRODUCED, DISTRIBUTED
OR USED AS A BASIS FOR MANUFACTURE
WITHOUT PRIOR WRITTEN PERMISSION
FROM KEYSTONE ELECTRONICS CORP.

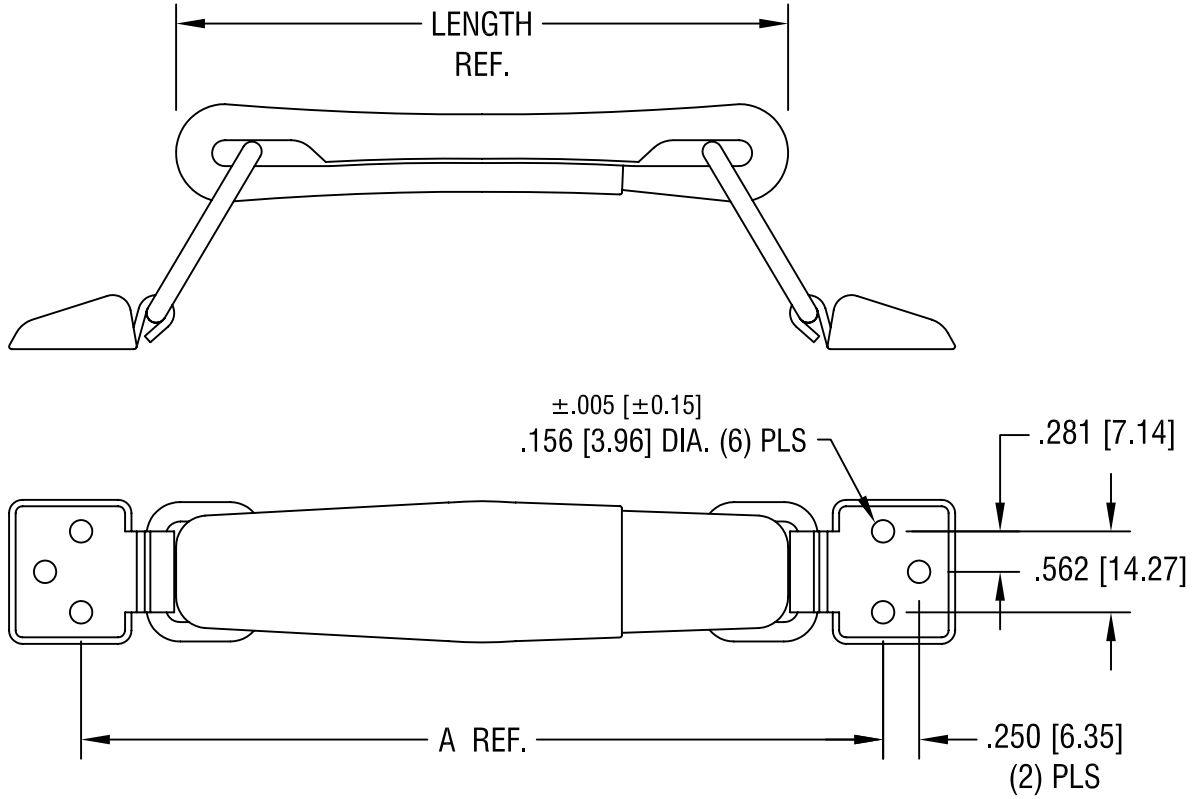

NOTES:

- 1 GRIP:
BLACK LEATHER LIKE MATERIAL
- 2 HARDWARE:
MAT'L: STEEL, NICKEL PLATE

PART NO.	LENGTH (REF.)	'A' DIM. (REF.)
8351	4.5 [114.3]	6.0 [152.4]
8352	5.5 [139.7]	7.0 [177.8]
8353	6.0 [152.4]	7.5 [190.5]

KEYSTONE ELECTRONICS CORP.			
ASTORIA, N.Y. 11105-2017			
PART NAME		CARRYING HANDLE	
MATERIAL		AS NOTED	
FINISH		DRN BY	DATE
AS NOTED		BOONE	11.18.05
		APP'D	SCALE
		LN	.75X
TOLERANCES	INCH [MM]	CODE	DWG NO.
DECIMAL	± .010 [± 0.25]	C/M	8351-8353
ANGULAR	± 1°		
UNLESS OTHERWISE SPECIFIED			

DATE	DESCRIPTION	REV.

Mouser Electronics

Authorized Distributor

Click to View Pricing, Inventory, Delivery & Lifecycle Information:

[Keystone Electronics:](#)

[8352](#)