

IEC Appliance Inlet C14 with Filter



See below:  
[Approvals and Compliances](#)

**Description**

- Panel mount :  
 Snap-in or screw-on mounting from front side
- 2 Functions :  
 Appliance Inlet Protection class I , Line filter in standard and medical version
- Quick connect terminals 6.3 x 0.8 mm

**Unique Selling Proposition**

- Ultra-compact design
- High quality filter case made of stainless steel
- Highly resistant since potted filter
- Various filter variants

**Characteristics**

- All single elements are already wired
- Suitable for use in equipment according to IEC/UL 60950  
 Suitable for use in medical equipment according to IEC/UL 60601-1

**Other versions on request**

- Capacity CX 100 nF
- Medical version M80

**References**

Alternative: version without line filter [6100-3](#); [6100-4](#)

**Weblinks**

[pdf datasheet](#), [html-datasheet](#), [General Product Information](#), [Distributor-Stock-Check](#), [Accessories](#), [Detailed request for product](#)

**Technical Data**

Ratings IEC	1 - 10A @ Ta 40 °C / 250VAC; 50Hz
Ratings UL/CSA	1 - 15A @ Ta 40 °C / 125VAC; 60Hz
Leakage Current	standard < 0.5mA (250V / 60Hz) medical < 5 µA (250 V / 60 Hz)
Dielectric Strength	> 1.7 kVDC between L-N > 2.7 kVDC between L/N-PE Test voltage (2 sec)
Allowable Operation Temperature	-25 °C to 85 °C
Climatic Category	25/085/21 acc. to IEC 60068-1
IP-Protection	from front side IP 40 acc. to IEC 60529
Protection Class	Suitable for appliances with protection class I acc. to IEC 61140
Terminal	Quick connect terminals 6.3 x 0.8 mm
Panel Thickness S	Screw: max 5 mm Mounting screw torque max 0.5Nm Snap-in: 0.8mm to 3mm
Material: Housing	Thermoplastic, black, UL 94V-0

appliance inlet/-outlet	C14 acc. to IEC 60320-1, UL 498, CSA C22.2 no. 42 (for cold conditions) pin-temperature 70 °C, 10A, Protection Class I
Line Filter	Standard and Medical Version, IEC 60939, UL 1283, CSA C22.2 no. 8 <a href="#">Technical Details</a>
MTBF	> 3'100'000h acc. to MIL-HB-217 F

**Approvals and Compliances**



Detailed information on product approvals, code requirements, usage instructions and detailed test conditions can be looked up in [Details about Approvals](#)

SCHURTER products are designed for use in industrial environments. They have approvals from independent testing bodies according to national and international standards. Products with specific characteristics and requirements such as required in the automotive sector according to IATF 16949, medical technology according to ISO 134485 or in the aerospace industry can be offered exclusively with customer-specific, individual agreements by SCHURTER.

## Approvals







The approval mark is used by the testing authorities to certify compliance with the safety requirements placed on electronic products.

Approval Reference Type: 5110

Approval Logo	Certificates	Certification Body	Description
	VDE Approvals	VDE	Certificate Number: 40035745
	UL Approvals	UL	UL File Number: E72928
	CQC Approvals	CQC	CQC File Number: CQC18001207813



## Product standards

Product standards that are referenced

Organization	Design	Standard	Description
	Designed according to	IEC 60320-1	Appliance couplers for household and similar general purposes
	Designed according to	IEC 60939	Passive filters for suppressing electromagnetic interference
	Designed according to	IEC 61058-1	Switches for appliances. Part 1. General requirements
	Designed according to	UL 498	Standard for Attachment Plugs and Receptacles
	Designed according to	UL 1283	Electromagnetic interference filters
	Designed according to	CSA C22.2 no. 42	General Use Receptacles, Attachment Plugs, and Similar Wiring Devices
	Designed according to	CSA C22.2 no. 8	Electromagnetic interference (EMI) filters





## Application standards

Application standards where the product can be used

Organization	Design	Standard	Description
	Designed for applications acc.	IEC/UL 60950	IEC 60950-1 includes the basic requirements for the safety of information technology equipment.
	Designed for applications acc.	IEC 60601-1	Medical electrical equipment - Part 1: General requirements for basic safety and essential performance

## Compliances

The product complies with following Guide Lines

Identification	Details	Initiator	Description
	CE declaration of conformity	SCHURTER AG	The CE marking declares that the product complies with the applicable requirements laid down in the harmonisation of Community legislation on its affixing in accordance with EU Regulation 765/2008.
	RoHS	SCHURTER AG	EU Directive RoHS 2011/65/EU
	China RoHS	SCHURTER AG	The law SJ / T 11363-2006 (China RoHS) has been in force since 1 March 2007. It is similar to the EU directive RoHS.
	REACH	SCHURTER AG	On 1 June 2007, Regulation (EC) No 1907/2006 on the Registration, Evaluation, Authorization and Restriction of Chemicals 1 (abbreviated as "REACH") entered into force.
	Medical Equipment	SCHURTER AG	Suitable for use in medical equipment according to IEC/UL 60601-1

**Dimensions [mm]**

Screw-on mounting

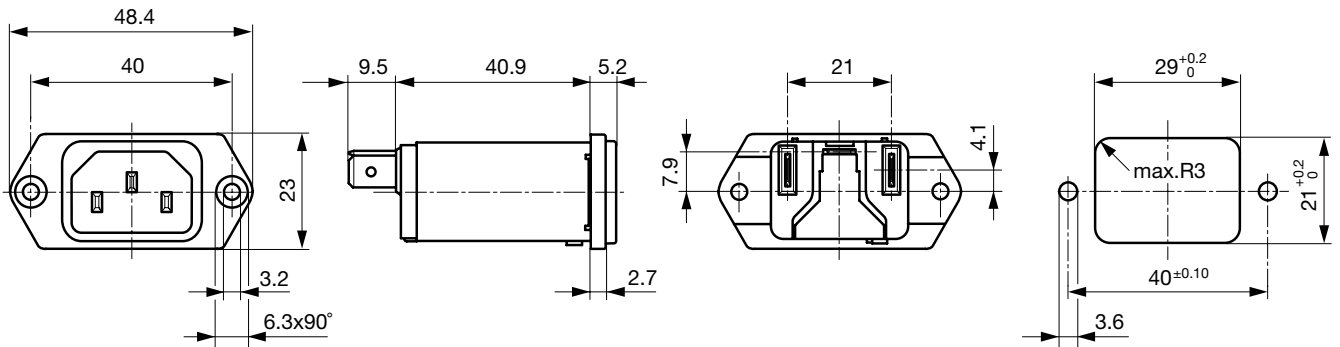

Snap-in mounting

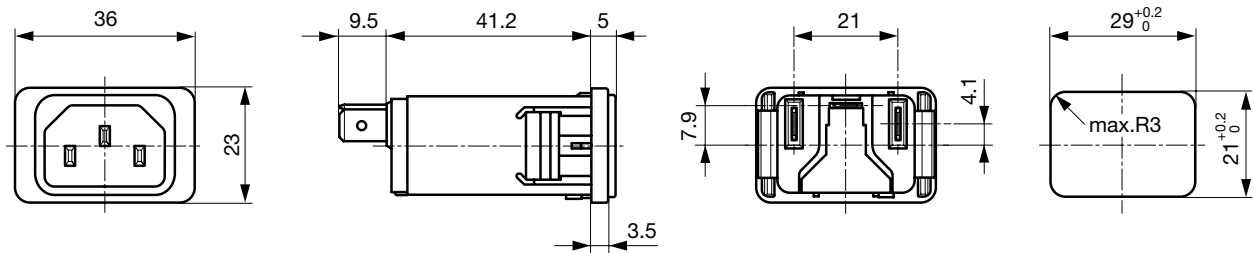

**Technical Data of Filter-Components**

Rated Current [A]	Filter-Type	Inductances L [mH]	Capacitance CX [nF]	Capacitance CY [nF]	R [mΩ]
1	Standard Version	2 x 11	47	2.2	-
2	Standard Version	2 x 4	47	2.2	-
3	Standard Version	2 x 2.5	47	2.2	-
4	Standard Version	2 x 1.6	47	2.2	-
6	Standard Version	2 x 0.7	47	2.2	-
8	Standard Version	2 x 0.6	47	2.2	-
10	Standard Version	2 x 0.4	47	2.2	-
15	Standard Version	2 x 0.1	47	2.2	-
1	Medical Version (M5)	2 x 11	47	-	1
2	Medical Version (M5)	2 x 4	47	-	1
3	Medical Version (M5)	2 x 2.5	47	-	1
4	Medical Version (M5)	2 x 1.6	47	-	1
6	Medical Version (M5)	2 x 0.7	47	-	1
8	Medical Version (M5)	2 x 0.6	47	-	1
10	Medical Version (M5)	2 x 0.4	47	-	1
15	Medical Version (M5)	2 x 0.1	47	-	1
10	Standard and Medical Version	2 x 0.4	47	2.2	1



All Variants

Rated Current [A]	Filter-Type	Panel mounting	Order Number
1	Standard Version	Snap-in	5110.0143.1
2	Standard Version	Snap-in	5110.0243.1
3	Standard Version	Snap-in	5110.0343.1
4	Standard Version	Snap-in	5110.0443.1
6	Standard Version	Snap-in	5110.0643.1
8	Standard Version	Snap-in	5110.0843.1
10	Standard Version	Snap-in	5110.1043.1
15	Standard Version	Snap-in	5110.1543.1
1	Standard Version	Screw	5110.0133.1
2	Standard Version	Screw	5110.0233.1
3	Standard Version	Screw	5110.0333.1
4	Standard Version	Screw	5110.0433.1
6	Standard Version	Screw	5110.0633.1
8	Standard Version	Screw	5110.0833.1
10	Standard Version	Screw	5110.1033.1
15	Standard Version	Screw	5110.1533.1
1	Medical Version (M5)	Snap-in	5110.0143.3
2	Medical Version (M5)	Snap-in	5110.0243.3
3	Medical Version (M5)	Snap-in	5110.0343.3
4	Medical Version (M5)	Snap-in	5110.0443.3
6	Medical Version (M5)	Snap-in	5110.0643.3
8	Medical Version (M5)	Snap-in	5110.0843.3
10	Medical Version (M5)	Snap-in	5110.1043.3
15	Medical Version (M5)	Snap-in	5110.1543.3
1	Medical Version (M5)	Screw	5110.0133.3
2	Medical Version (M5)	Screw	5110.0233.3
3	Medical Version (M5)	Screw	5110.0333.3
4	Medical Version (M5)	Screw	5110.0433.3
6	Medical Version (M5)	Screw	5110.0633.3
8	Medical Version (M5)	Screw	5110.0833.3
10	Medical Version (M5)	Screw	5110.1033.3
15	Medical Version (M5)	Screw	5110.1533.3

Most Popular.

Availability for all products can be searched real-time:<https://www.schurter.com/en/Stock-Check/Stock-Check-SCHURTER>

Packaging unit 10 Pcs

Accessories

Description



**Wire Harness**  
 Wire harness for SCHURTER products



**Assorted Covers**  
 Rear Cover

0859.0048



**Cord retaining kits**  
 Cord retaining strain relief

Flat head, A	4700.0001
Countersunk, C	4700.0003

Mating Outlets/Connectors

Category / Description

[Appliance Outlet Overview complete](#)



IEC Appliance Outlet F, Screw-on Mounting, Front Side, Solder Terminal	4787
IEC Appliance Outlet F, Snap-in Mounting, Front Side, Solder or Quick-connect Terminal	4788
IEC Appliance Outlet F or H, Screw-on Mounting, Front Side, Solder, PCB or Quick-connect Terminal	5091

[Appliance Outlet further types to 5110](#)

[Connector Overview complete](#)



4782 Mounting: Power Cord, 3 x 1 mm <sup>2</sup> / 3 x 18 AWG, Cable, Connector: IEC C13	4782
4785 Mounting: Power Cord, 3 x 1 mm <sup>2</sup> / 3 x 18 AWG, Cable, Connector: IEC C13	4785
4300-06 Mounting: Power Cord, 3 x 1 mm <sup>2</sup> / 3 x 18 AWG, Cable, Connector: IEC C13	4300-06
IEC Connector C15 for hot conditions 120°C, Rewireable, Straight	4781
IEC Connector C15 for hot conditions 120°C, Rewireable, Angled	4784

[Connector further types to 5110](#)

...

# Mouser Electronics

Authorized Distributor

Click to View Pricing, Inventory, Delivery & Lifecycle Information:

## Schurter:

[5110.1033.3](#) [5110.1033.1](#) [5110.0343.1](#) [5110.0343.3](#) [5110.0333.3](#) [5110.0333.1](#) [5110.1543.3](#) [5110.1543.1](#)  
[5110.0633.3](#) [5110.0633.1](#) [5110.0833.3](#) [5110.0833.1](#) [5110.1043.1](#) [5110.1043.3](#) [5110.0133.3](#) [5110.0133.1](#)  
[5110.1533.3](#) [5110.1533.1](#) [5110.0643.1](#) [5110.0643.3](#) [5110.0843.3](#) [5110.0843.1](#) [5110.0143.1](#) [5110.0143.3](#)  
[5110.0233.3](#) [5110.0233.1](#) [5110.0243.1](#) [5110.0243.3](#) [5110.0433.1](#) [5110.0433.3](#) [5110.0443.1](#) [5110.0443.3](#)  
[5110.0643.6](#)