

DC Fan



60×60×38 mm

San Ace 60 9GA type Low Power Consumption Fan

General Specifications

- Material Frame: Plastic (Flammability: UL 94V-0), Impeller: Plastic (Flammability: UL 94V-0)
- Expected life See the table below. (L10 life: 90% survival rate for continuous operation in free air at 60°C, rated voltage)
Expected life at 40°C is for reference only.
- Motor protection function Locked rotor burnout protection, Reverse polarity protection
For details, please refer to p. 573.
- Dielectric strength 50/60 Hz, 500 VAC, for 1 minute (between lead wire conductors and frame)
- Insulation resistance 10 MΩ or more with a 500 VDC megger (between lead wire conductors and frame)
- Sound pressure level (SPL) At 1 m away from the air inlet
- Storage temperature -30 to +70°C (Non-condensing)
- Lead wire ⊕Red ⊖Black Sensor Yellow Control Brown
- Mass 130 g

Specifications

The models listed below **have ribs and pulse sensors with PWM control function.** For models without ribs, append "1" to the end of model numbers.

Model no.	Rated voltage [V]	Operating voltage range [V]	PWM duty cycle* [%]	Rated current [A]	Rated input [W]	Rated speed [min ⁻¹]	Max. airflow [m ³ /min] [CFM]	Max. static pressure [Pa] [inchH ₂ O]	SPL [dB (A)]	Operating temperature [°C]	Expected life [h]	
9GA0612P1J03	12	10.8 to 12.6	100	1.5	18.0	17500	1.75 62	820 3.3	63	-20 to +60	40000/60°C (70000/40°C)	
			20	0.1	1.2	4000	0.4 14	43 0.17	24			
9GA0612P1K03		10.8 to 13.2	100	0.95	11.4	14800	1.5 53	600 2.4	59	-20 to +70		
			20	0.1	1.2	4000	0.4 14	43 0.17	24			
9GA0612P1K60		10.8 to 13.2	100	0.95	11.4	14800	1.5 53	675 2.7	59	-20 to +60		
			0	0.05	0.6	1480	0.134 4.7	8.3 0.03	16			
9GA0612P1H03		10.8 to 13.2	100	0.55	6.6	11500	1.15 40	375 1.5	52	-20 to +70		
			20	0.06	0.72	2600	0.27 9.5	20 0.08	19			
9GA0624P1J03		24	21.6 to 25.2	100	0.75	18.0	17500	1.75 62	820 3.3	63		-20 to +60
				20	0.1	2.4	6200	0.63 22	104 0.42	35		
9GA0624P1K03			21.6 to 26.4	100	0.5	12	14800	1.5 53.0	600 2.4	59		-20 to +70
				20	0.06	1.44	5000	0.5 17.7	70 0.28	28		

* PWM input frequency is 25 kHz; models without specifications at 0% PWM duty cycle have zero fan speed at 0%.

The following sensor and control options are available for selection.

Differs according to the model. Refer to the table on p. 603. Without sensor Pulse sensor Lock sensor

The mark indicates Short Lead Time Service applicable models. See p. 626 for details.

Airflow - Static Pressure Characteristics / PWM Duty - Speed Characteristics Example

9GA0612P1J03 With pulse sensor with PWM control function

PWM duty cycle

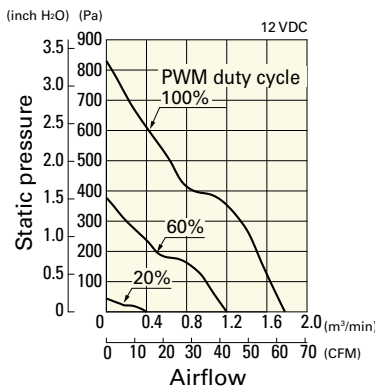

Operating voltage range

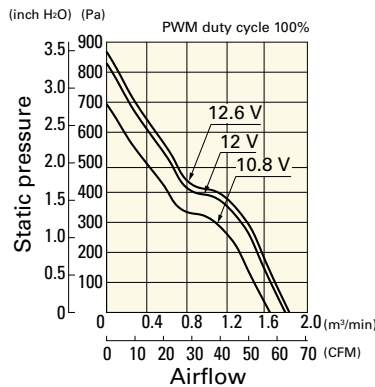

PWM duty - Speed characteristics example

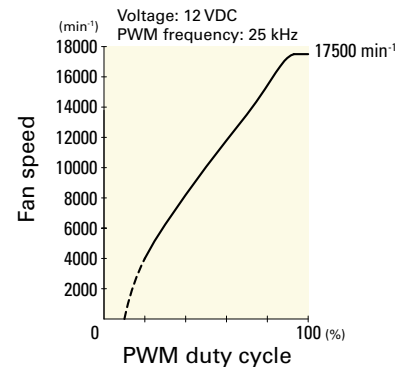

Airflow - Static Pressure Characteristics / PWM Duty - Speed Characteristics Example

9GA0612P1K03 With pulse sensor with PWM control function

PWM duty cycle

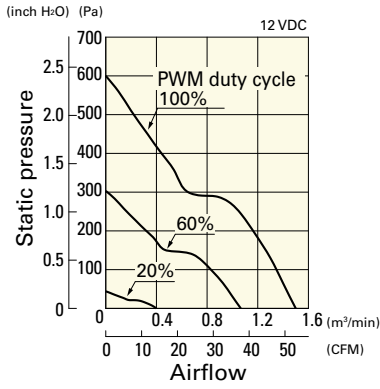

Operating voltage range

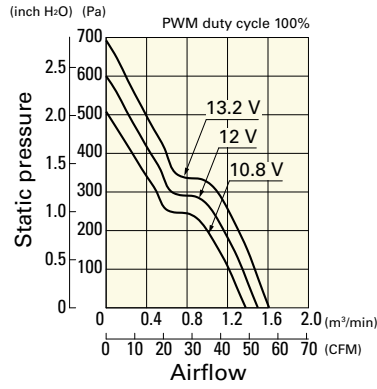

PWM duty - Speed characteristics example

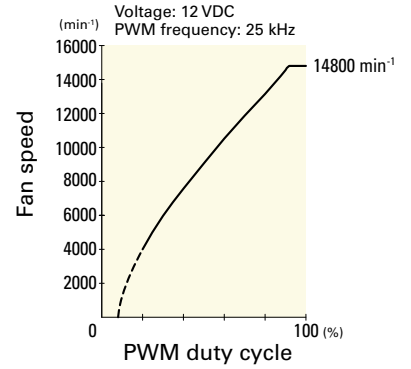

9GA0612P1K60 With pulse sensor with PWM control function

PWM duty cycle

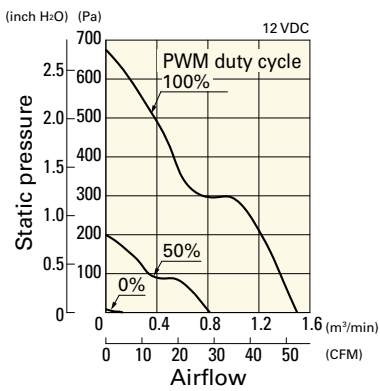

Operating voltage range

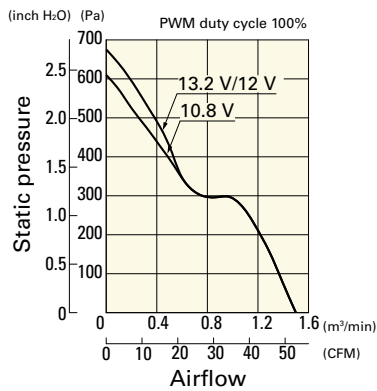

PWM duty - Speed characteristics example

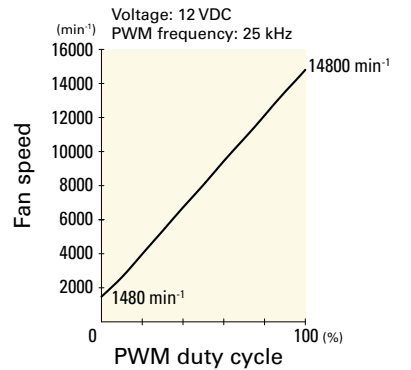

9GA0612P1H03 With pulse sensor with PWM control function

PWM duty cycle

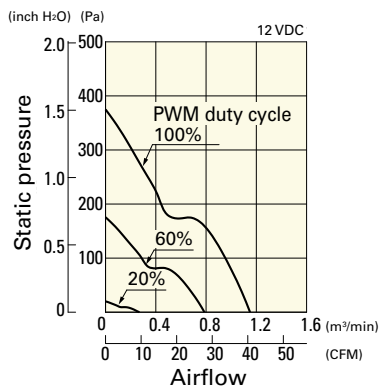

Operating voltage range

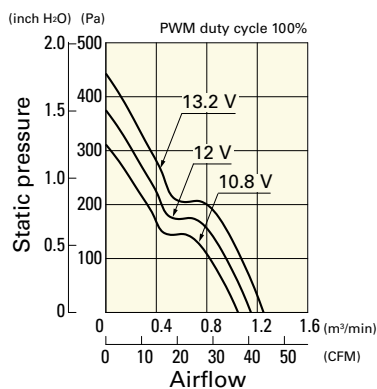

PWM duty - Speed characteristics example

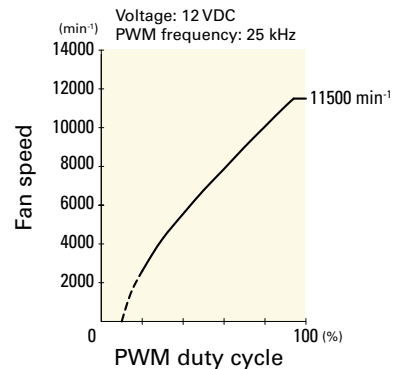

9GA0624P1J03 With pulse sensor with PWM control function

PWM duty cycle

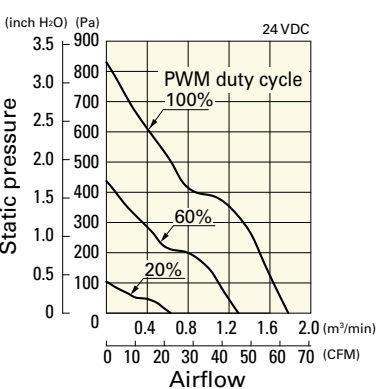

Operating voltage range

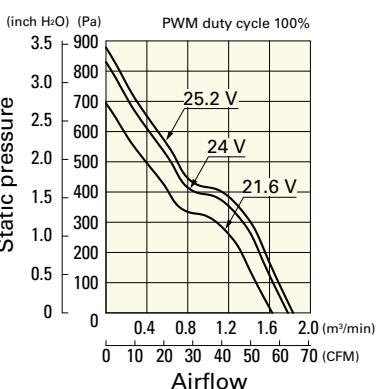

PWM duty - Speed characteristics example

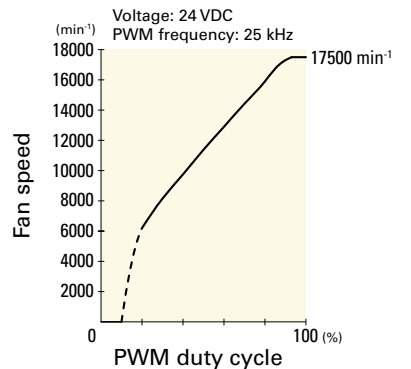

Airflow - Static Pressure Characteristics / PWM Duty - Speed Characteristics Example

9GA0624P1K03 With pulse sensor with PWM control function

PWM duty cycle

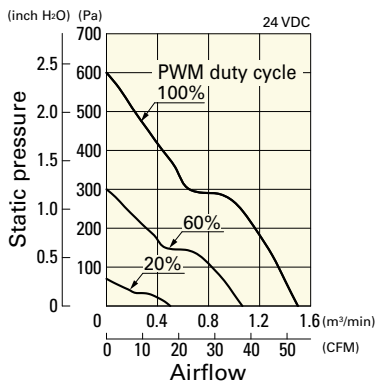

Operating voltage range

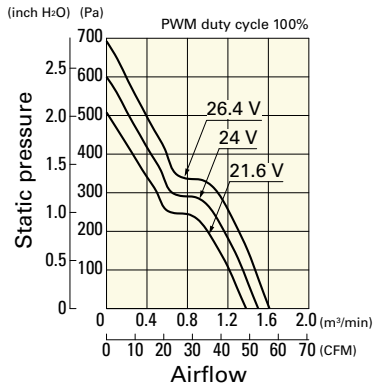

PWM duty - Speed characteristics example

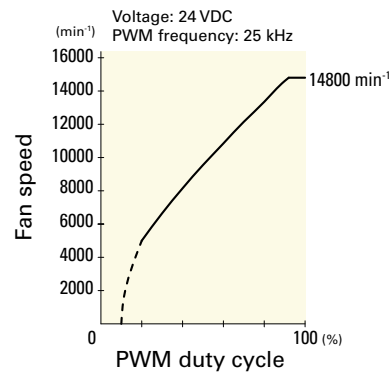

Dimensions (unit: mm) (With ribs)

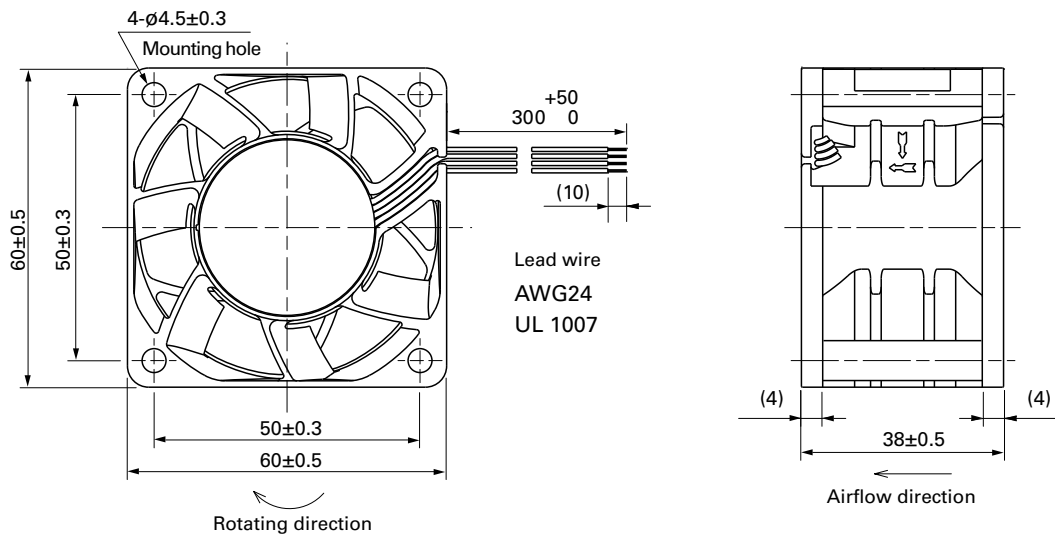

Reference Dimensions of Mounting Holes and Vent Opening (unit: mm)

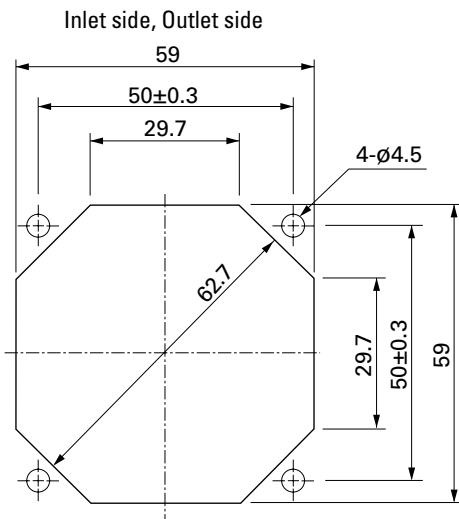

Options

Finger guards

page: p. 558

Model no.: 109-139E, 109-139H

Resin finger guards

page: p. 565

Model no.: 109-1003G

Resin filter kits

page: p. 566

Model no.: 109-1003F13 (13PPI), 109-1003F20 (20PPI),
109-1003F30 (30PPI), 109-1003F40 (40PPI)