

1

2

3

4

5

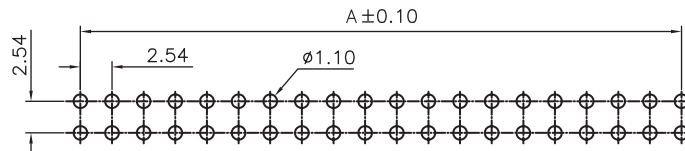

PCB LAYOUT - COMPONENT VIEW

TECHNICAL CHARACTERISTICS

MATERIAL
 INSULATOR: PBT
 COLOR: BLACK
 CONTACT MATERIAL: COPPER ALLOY
 CONTACT TYPE: STAMPED
 CONTACT PLATING: GOLD
 QUALITY CLASS: 3 AS PER CECC 75 301-802
 PITCH: 2.54MM

ENVIRONMENTAL
 OPERATING TEMPERATURE: -40 UP TO 125°C
 FLAMABILITY RATING: UL94-V0
 COMPLIANCE: LEAD FREE AND ROHS

ELECTRICAL
 CURRENT RATING: 3 A MAX
 WORKING VOLTAGE: 250 VAC
 INSULATOR RESISTANCE: >1000 MOHM
 DIELECTRIC WITHSTANDING VOLTAGE: 500 VAC/MN
 CONTACT RESISTANCE: 20 mOHM MAX

STANDARD
 CERTIFIED: E323964

SOLDERING
 JEDEC LEAD FREE WAVE SOLDERING PROCESS

PACKAGING
 TRAY

DIMENSION
 A = 2.54 x (NB. PIN / 2 - 1)
 B = 2.54 x (NB. PIN / 2) + 7.66
 C = 2.54 x (NB. PIN / 2 - 1) + 7.88

A

B

C

D

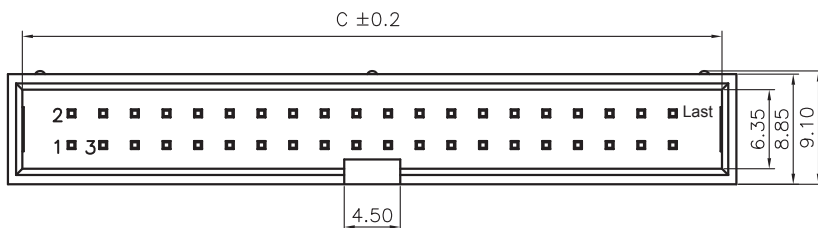
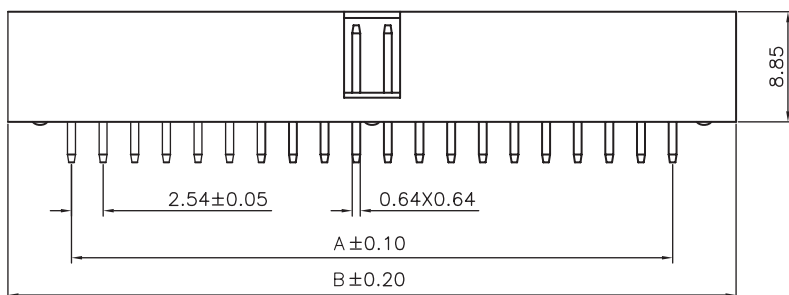
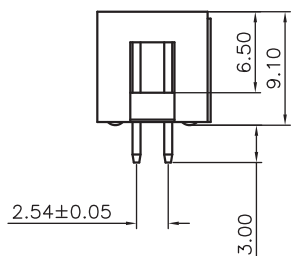

61203921621: pin 20 removed



NOTES:
 No. Of Positions 50-64 With 3 Keys
 All Oher Pin With 1 Key

RoHS Compliant				PROJECTION: 	GENERAL TOLERANCE .X = +/- 0.2 .XX = +/- 0.15		DESCRIPTION: 2.54MM MALE BOX HEADER	SIZE A4
APPROVAL: FBr								
H	06-APR-16	DRAWING	AK	SCALE:	SHEET: 1/3			
REV	DATE	FILE	BY	DRAW: PEARL				

1

2

3

4

5

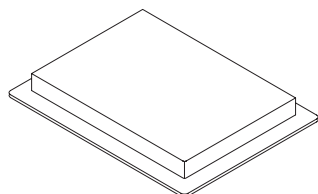

TRAY

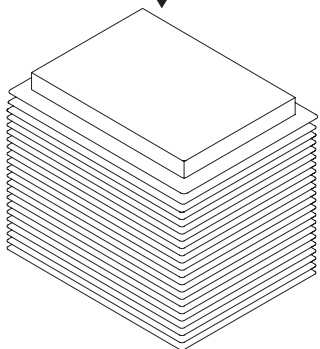

25TRAYS

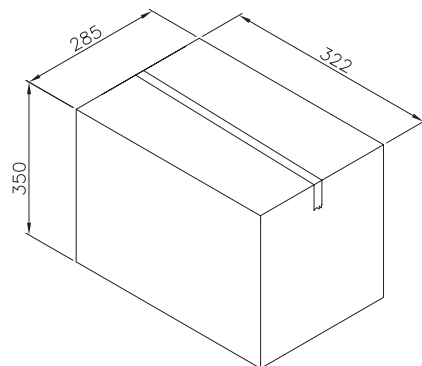
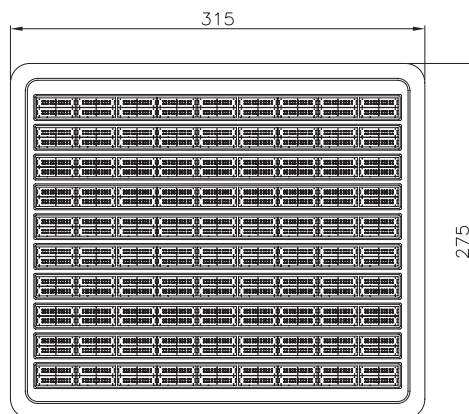

CARTON

Note:

1.Dimension:

Tray Size:315(L)x275(W)x15.4(H) (mm)

Carton Size:322(L)x285(W)x350(H) (mm)

2.Quantity:

Circuits	Pcs/Tray	Trays/Carton	Q'TY
06	360	25	9000
08	300	25	7500
10	260	25	6500
12	240	25	6000
14	200	25	5000
16	180	25	4500
20	160	25	4000
24	140	25	3500
26	120	25	3000
30	120	25	3000
34	100	25	2500
40	80	25	2000
50	60	25	1500
60	60	25	1500
64	60	25	1500

RoHS Compliant

PROJECTION:



GENERAL TOLERANCE

.X = \pm 0.2.XX = \pm 0.15

WÜRTH ELEKTRONIK

APPROVAL: GMo

UNIT: MM

SCALE:

SHEET: 2/3

DRAW: PEARL

DESCRIPTION: 2.54MM MALE BOX HEADER

WERI PART NO: 612 0xx 216 21

SIZE

A4

REV	DATE	FILE	BY
G			
F			
E			
D			
C			
B			
A			

1

2

3

4

5

Cautions and Warnings:

This electronic component is designed and developed with the intention for use in general electronics equipments.

Before incorporating the components into any equipments in the field such as aerospace, aviation, nuclear control, submarine, transportation, (automotive control, train control, ship control), transportation signal, disaster prevention, medical, public information network etc. where higher safety and reliability are especially required or if there is possibility of direct damage or injury to human body, Würth Elektronik must be asked for a written approval.

In addition, even electronic component in general electronic equipments, when used in electrical circuits that require high safety, reliability functions or performance, the sufficient reliability evaluation-check for the safety must be performed before by the user before usage.

A

B

C

RoHS Compliant

PROJECTION:



GENERAL TOLERANCE

.X = +/- 0.2

.XX = +/- 0.15



APPROVAL: JC

UNIT: MM

SCALE:

SHEET: 3/3

DRAW: QL



DESCRIPTION: DISCLAIMER

WERI PART NO: DISCLAIMER

SIZE

A4

D

G				PROJECTION: 	GENERAL TOLERANCE .X = +/- 0.2 .XX = +/- 0.15		DESCRIPTION: DISCLAIMER	SIZE A4	
F									
E									
D									
C				APPROVAL: JC	UNIT: MM		DESCRIPTION: DISCLAIMER	SIZE A4	
B					SCALE:				
A	10-SEP-14	PDF	QL		SHEET: 3/3				WERI PART NO: DISCLAIMER
REV	DATE	FILE	BY		DRAW: QL				

Mouser Electronics

Authorized Distributor

Click to View Pricing, Inventory, Delivery & Lifecycle Information:

Würth Electronics:

[61202021621](#) [61201621621](#) [61201021621](#) [61202621621](#) [61200821621](#) [61203921621](#) [61202421621](#)
[61203421621](#) [61201421621](#) [61200621621](#) [61205021621](#) [61206021621](#) [61204021621](#)