

LM4950 Boomer™ Audio Power Amplifier Series 7.5W Mono-BTL or 3.1W Stereo Audio Power Amplifier

Check for Samples: [LM4950](#)

FEATURES

- Pop & Click Circuitry Eliminates Noise During Turn-On and Turn-Off Transitions
- Low Current, Active-Low Shutdown Mode
- Low Quiescent Current
- Stereo 3.1W Output, $R_L = 4\Omega$
- Mono 7.5W BTL Output, $R_L = 8\Omega$
- Short Circuit Protection
- Unity-Gain Stable
- External Gain Configuration Capability

KEY SPECIFICATIONS

- Quiescent Power Supply Current 16mA (typ)
- P_{OUT} (SE)
 - $V_{DD} = 12V$, $R_L = 4\Omega$, 1% THD+N: 3.1W (typ)
- P_{OUT} (BTL)
 - $V_{DD} = 12V$, $R_L = 8\Omega$, 10% THD+N: 7.5W (typ)
- Shutdown Current 40 μ A (typ)

APPLICATIONS

- Flat Panel Monitors
- Flat Panel TVs
- Computer Sound Cards

DESCRIPTION

The LM4950 is a dual audio power amplifier primarily designed for demanding applications in flat panel monitors and TV's. It is capable of delivering 3.1 watts per channel to a 4 Ω single-ended load with less than 1% THD+N or 7.5 watts mono BTL to an 8 Ω load, with less than 10% THD+N from a 12V_{DC} power supply.

Boomer audio power amplifiers were designed specifically to provide high quality output power with a minimal amount of external components. The LM4950 does not require bootstrap capacitors or snubber circuits. Therefore, it is ideally suited for display applications requiring high power and minimal size.

The LM4950 features a low-power consumption active-low shutdown mode. Additionally, the LM4950 features an internal thermal shutdown protection mechanism along with short circuit protection.

The LM4950 contains advanced pop & click circuitry that eliminates noises which would otherwise occur during turn-on and turn-off transitions.

The LM4950 is a unity-gain stable and can be configured by external gain-setting resistors.



Please be aware that an important notice concerning availability, standard warranty, and use in critical applications of Texas Instruments semiconductor products and disclaimers thereto appears at the end of this data sheet.

is a trademark of ~ Texas Instruments Incorporated.

All other trademarks are the property of their respective owners.

TYPICAL APPLICATION

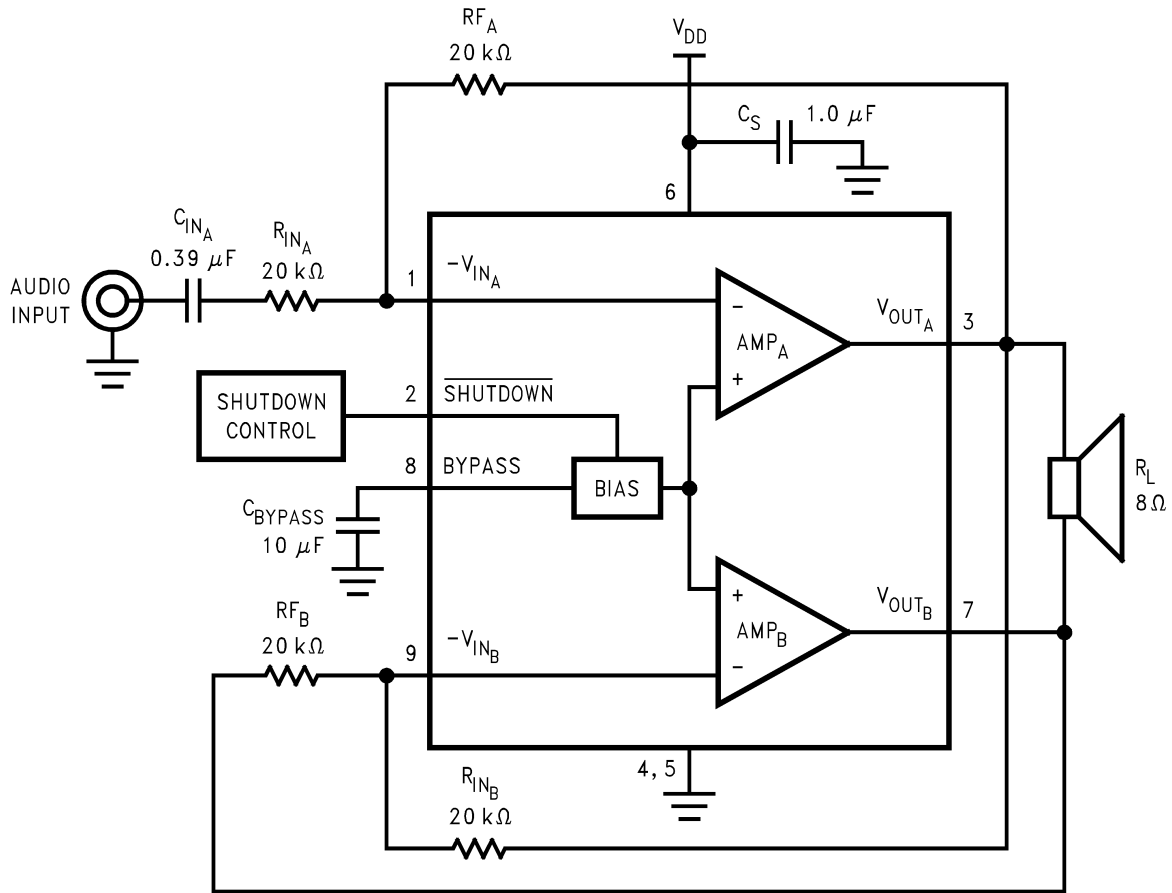
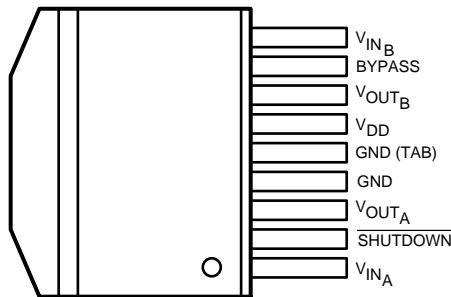
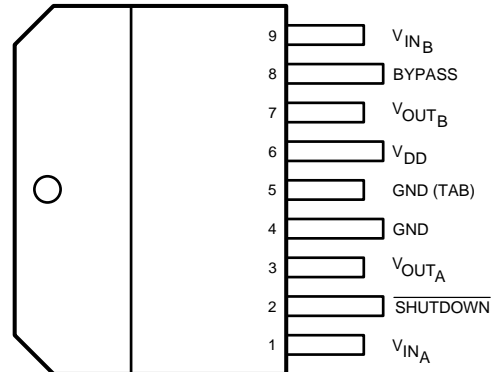

Figure 1. Typical Bridge-Tied-Load (BTL) Audio Amplifier Application Circuit

Connection Diagrams



**Figure 2. Plastic Package, DDPAK
Top View
See Package Number KTW0009A**



**Figure 3. Plastic Package, TO-220
Top View
See Package Number NEC0009A**



These devices have limited built-in ESD protection. The leads should be shorted together or the device placed in conductive foam during storage or handling to prevent electrostatic damage to the MOS gates.

Absolute Maximum Ratings⁽¹⁾⁽²⁾⁽³⁾

Supply Voltage (pin 6, referenced to GND, pins 4 and 5)		18.0V
Storage Temperature		-65°C to +150°C
Input Voltage	pins 3 and 7	-0.3V to $V_{DD} + 0.3V$
	pins 1, 2, 8, and 9	-0.3V to 9.5V
Power Dissipation ⁽⁴⁾		Internally limited
ESD Susceptibility	Human Body Model ⁽⁵⁾	2000V
	Machine Model ⁽⁶⁾	200V
Junction Temperature		150°C
Thermal Resistance	θ_{JC} (KTW)	4°C/W
	θ_{JA} (KTW) ⁽⁴⁾	20°C/W
	θ_{JC} (NEC)	4°C/W
	θ_{JA} (NEC) ⁽⁴⁾	20°C/W

- (1) All voltages are measured with respect to the GND pin, unless otherwise specified.
- (2) [Absolute Maximum Ratings](#) indicate limits beyond which damage to the device may occur. [Operating Ratings](#) indicate conditions for which the device is functional, but do not ensure specific performance limits. [Electrical Characteristics VDD = 12V](#) state DC and AC electrical specifications under particular test conditions which ensure specific performance limits. This assumes that the device is within the Operating Ratings. Specifications are not specified for parameters where no limit is given, however, the typical value is a good indication of device performance.
- (3) If Military/Aerospace specified devices are required, please contact the Texas Instruments Sales Office/Distributors for availability and specifications.
- (4) The maximum power dissipation must be derated at elevated temperatures and is dictated by T_{JMAX} , θ_{JA} , and the ambient temperature, T_A . The maximum allowable power dissipation is $P_{DMAX} = (T_{JMAX} - T_A) / \theta_{JA}$ or the given in [Absolute Maximum Ratings](#), whichever is lower. For the LM4950 typical application (shown in [Figure 1](#)) with $V_{DD} = 12V$, $R_L = 4\Omega$ stereo operation the total power dissipation is 3.65W. $\theta_{JA} = 20^\circ\text{C/W}$ for both DDPAK and TO220 packages mounted to 16in² heatsink surface area.
- (5) Human body model, 100pF discharged through a 1.5 k Ω resistor.
- (6) Machine Model, 220pF–240pF discharged through all pins.

Operating Ratings

Temperature Range ($T_{MIN} \leq T_A \leq T_{MAX}$)	$-40^\circ\text{C} \leq T_A \leq 85^\circ\text{C}$
Supply Voltage	$9.6V \leq V_{DD} \leq 16V$

Electrical Characteristics $V_{DD} = 12V^{(1)(2)}$

The following specifications apply for $V_{DD} = 12V$, $A_V = 0dB$ (SE) or $6dB$ (BTL) unless otherwise specified. Limits apply for $T_A = 25^\circ C$.

Symbol	Parameter	Conditions	LM4950		Units (Limits)
			Typical ⁽³⁾	Limit ⁽⁴⁾⁽⁵⁾	
I_{DD}	Quiescent Power Supply Current	$V_{IN} = 0V$, $I_O = 0A$, No Load	16	30	mA (max)
I_{SD}	Shutdown Current	$V_{SHUTDOWN} = GND^{(6)}$	40	80	μA (max)
V_{OS}	Offset Voltage	$V_{IN} = 0V$, $R_L = 8\Omega$	5	30	mV (max)
V_{SDIH}	Shutdown Voltage Input High			2.0 $V_{DD}/2$	V (min) V (max)
V_{SDIL}	Shutdown Voltage Input Low			0.4	V (max)
T_{WU}	Wake-up Time	$C_B = 10\mu F$	440		ms
TSD	Thermal Shutdown Temperature		170	150 190	$^\circ C$ (min) $^\circ C$ (max)
P_O	Output Power	$f = 1kHz$ $R_L = 4\Omega$ SE, Single Channel, THD+N = 1% $R_L = 8\Omega$ BTL, THD+N = 10%	3.1 7.5	3.0	W (min)
THD+N	Total Harmonic Distortion + Noise	$P_O = 2.5W_{rms}$; $f = 1kHz$; $R_L = 4\Omega$ SE	0.05		%
		$P_O = 2.5W_{rms}$; $A_V = 10$; $f = 1kHz$; $R_L = 4\Omega$, SE	0.14		
ϵ_{OS}	Output Noise	A-Weighted Filter, $V_{IN} = 0V$, Input Referred	10		μV
X_{TALK}	Channel Separation	$f_{IN} = 1kHz$, $P_O = 1W$, SE Mode $R_L = 8\Omega$ $R_L = 4\Omega$	76 70		dB
PSRR	Power Supply Rejection Ratio	$V_{RIPPLE} = 200mV_{p-p}$, $f = 1kHz$, $R_L = 8\Omega$, BTL	70	56	dB (min)
I_{OL}	Output Current Limit	$V_{IN} = 0V$, $R_L = 500m\Omega$	5		A

- (1) All voltages are measured with respect to the GND pin, unless otherwise specified.
- (2) [Absolute Maximum Ratings](#) indicate limits beyond which damage to the device may occur. [Operating Ratings](#) indicate conditions for which the device is functional, but do not ensure specific performance limits. [Electrical Characteristics \$V_{DD} = 12V\$](#) state DC and AC electrical specifications under particular test conditions which ensure specific performance limits. This assumes that the device is within the Operating Ratings. Specifications are not specified for parameters where no limit is given, however, the typical value is a good indication of device performance.
- (3) Typicals are measured at $25^\circ C$ and represent the parametric norm.
- (4) Limits are specified to AOQL (Average Outgoing Quality Level).
- (5) Datasheet min/max specification limits are specified by design, test, or statistical analysis.
- (6) Shutdown current is measured in a normal room environment. The Shutdown pin should be driven as close as possible to GND for minimum shutdown current.

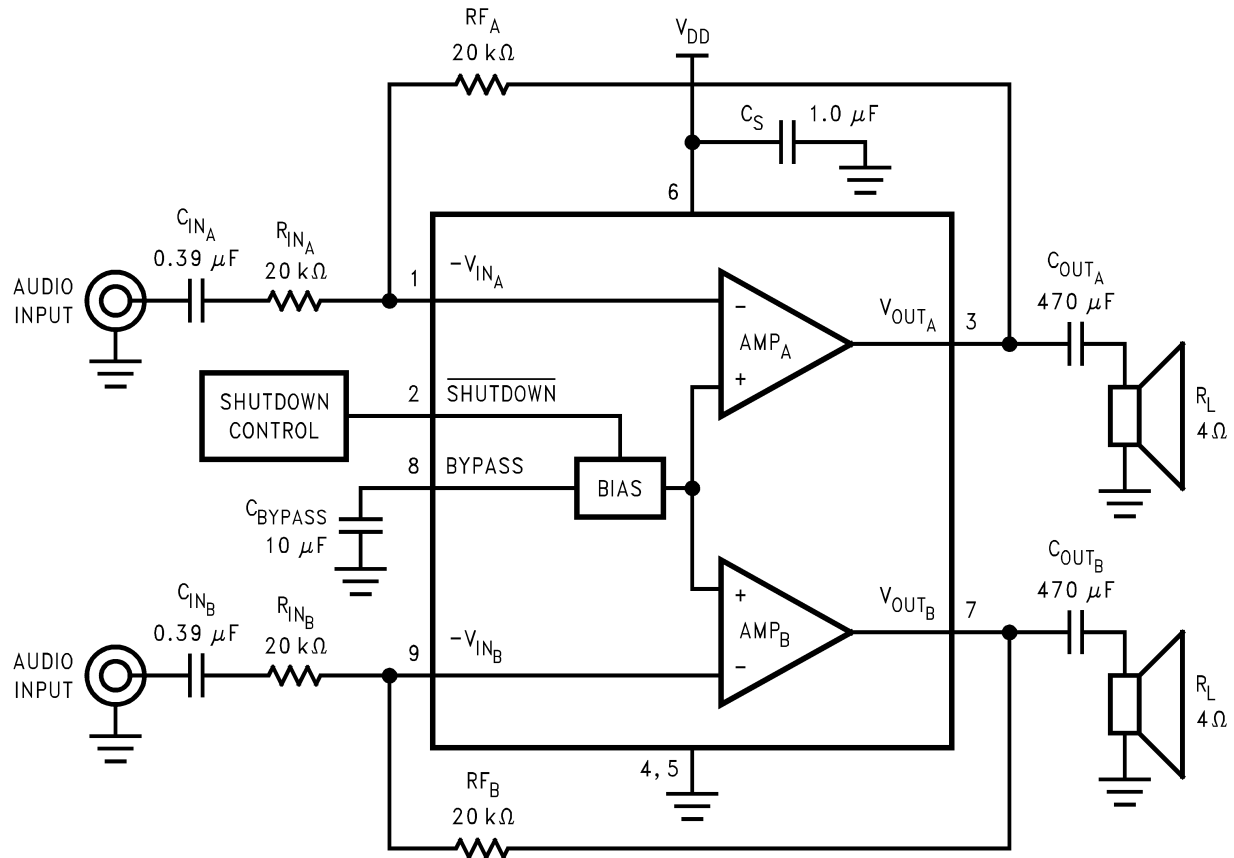

Figure 4. Typical Stereo Single-Ended (SE) Audio Amplifier Application Circuit

External Components Description

See Figure 1.

Components	Functional Description
1. R_{IN}	This is the inverting input resistance that, along with R_F , sets the closed-loop gain. Input resistance R_{IN} and input capacitance C_{IN} form a high pass filter. The filter's cutoff frequency is $f_c = 1/(2\pi R_{IN} C_{IN})$.
2. C_{IN}	This is the input coupling capacitor. It blocks DC voltage at the amplifier's inverting input. C_{IN} and R_{IN} create a highpass filter. The filter's cutoff frequency is $f_c = 1/(2\pi R_{IN} C_{IN})$. Refer to SELECTING EXTERNAL COMPONENTS , for an explanation of determining C_{IN} 's value.
3. R_F	This is the feedback resistance that, along with R_i , sets closed-loop gain.
4. C_S	The supply bypass capacitor. Refer to the POWER SUPPLY BYPASSING for information about properly placing, and selecting the value of, this capacitor.
5. C_{BYPASS}	This capacitor filters the half-supply voltage present on the BYPASS pin. Refer to SELECTING EXTERNAL COMPONENTS for information about properly placing, and selecting the value of, this capacitor.

Typical Performance Characteristics

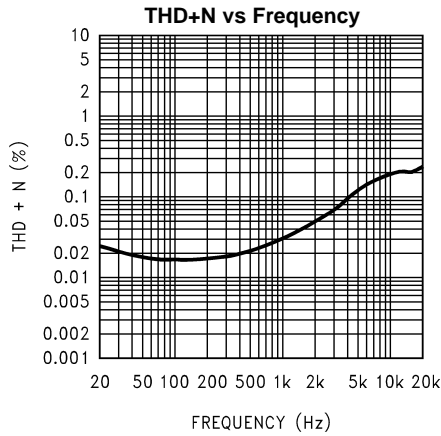

Figure 5. $V_{DD} = 12V$, $R_L = 8\Omega$
BTL operation, $P_{OUT} = 1W$

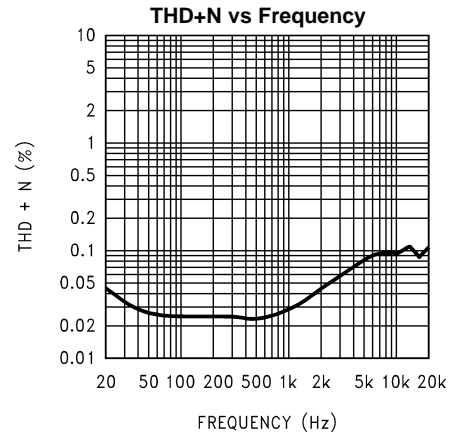

Figure 6. $V_{DD} = 12V$, $R_L = 8\Omega$
BTL operation, $P_{OUT} = 3W$

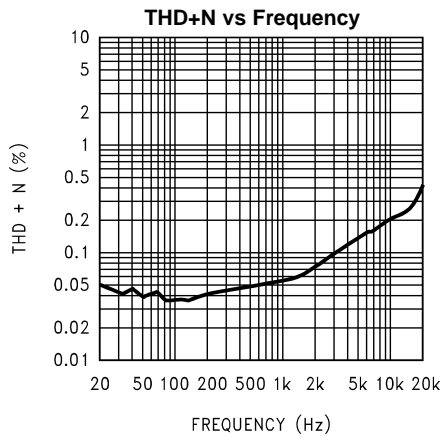

Figure 7. $V_{DD} = 12V$, $R_L = 8\Omega$
BTL operation, $P_{OUT} = 5W$

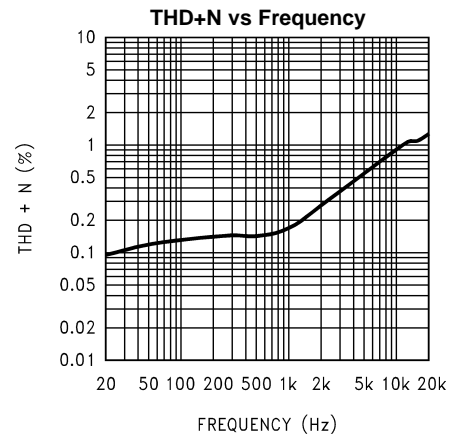

Figure 8. $V_{DD} = 12V$, $R_L = 8\Omega$
BTL operation, $BTLA_V = 20$, $P_{OUT} = 1W$

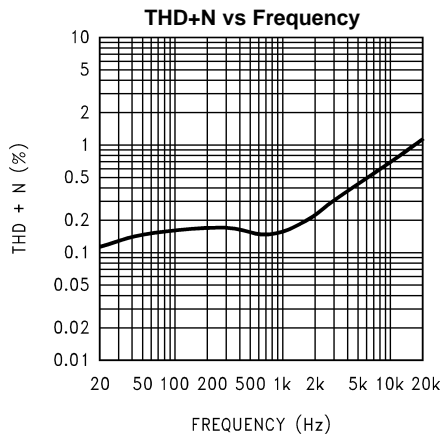

Figure 9. $V_{DD} = 12V$, $R_L = 8\Omega$
BTL operation, $BTLA_V = 20$, $P_{OUT} = 3W$

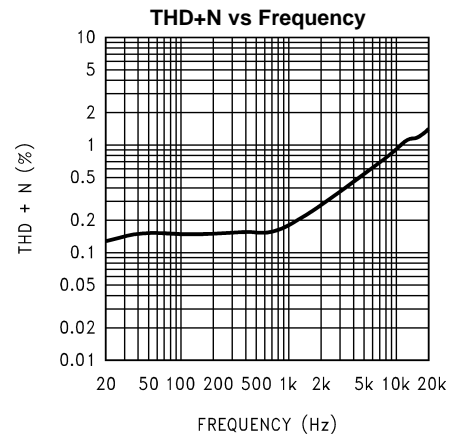

Figure 10. $V_{DD} = 12V$, $R_L = 8\Omega$
BTL operation, $BTLA_V = 20$, $P_{OUT} = 5W$

Typical Performance Characteristics (continued)

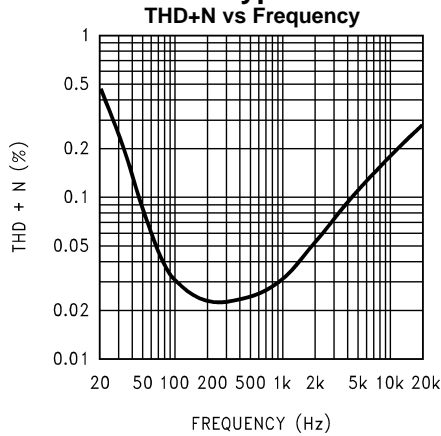

Figure 11. $V_{DD} = 12V$, $R_L = 4\Omega$, SE operation, both channels driven and loaded (average shown), $P_{OUT} = 1W$, $A_V = 1$

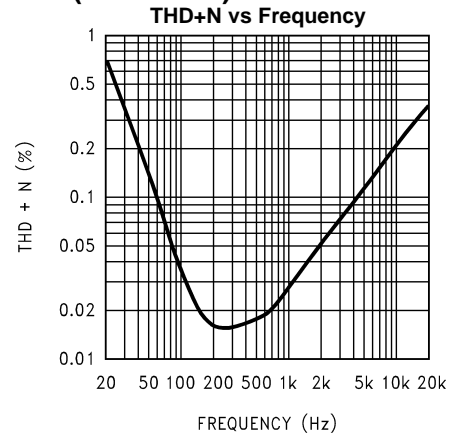

Figure 12. $V_{DD} = 12V$, $R_L = 4\Omega$, SE operation, both channels driven and loaded (average shown), $P_{OUT} = 2.5W$, $A_V = 1$

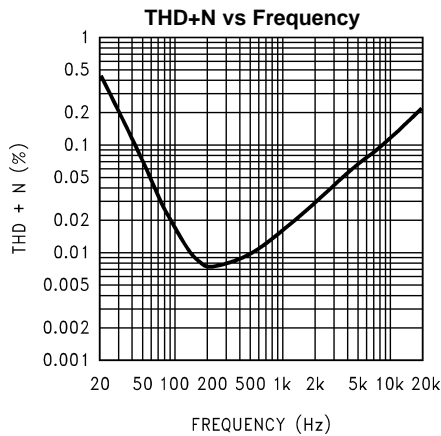

Figure 13. $V_{DD} = 12V$, $R_L = 8\Omega$, SE operation, both channels driven and loaded (average shown), $P_{OUT} = 1W$, $A_V = 1$

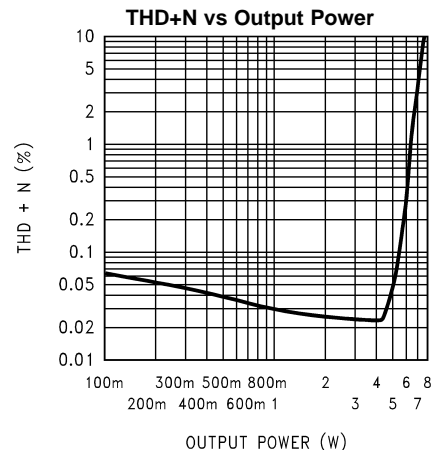

Figure 14. $V_{DD} = 12V$, $R_L = 8\Omega$, BTL operation, $f_{IN} = 1kHz$

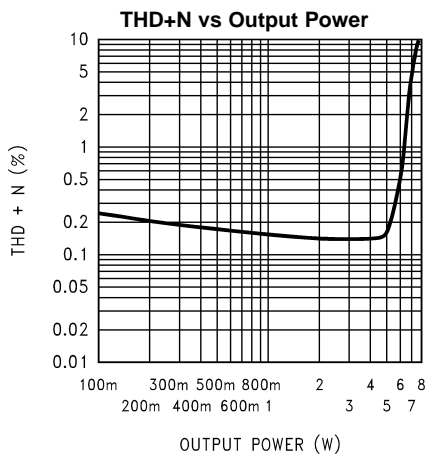

Figure 15. $V_{DD} = 12V$, $R_L = 8\Omega$, BTL operation, $BTLA_V = 20$, $f_{IN} = 1kHz$

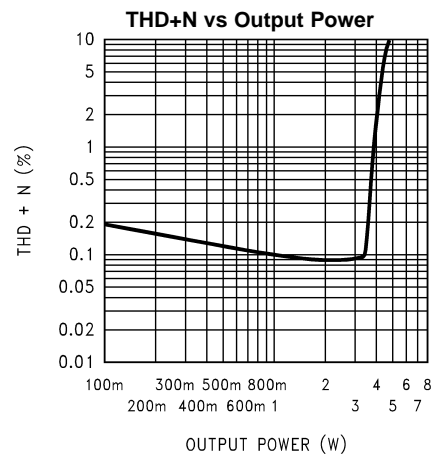

Figure 16. $V_{DD} = 12V$, $R_L = 16\Omega$, BTL operation, $BTLA_V = 20$, $f_{IN} = 1kHz$

Typical Performance Characteristics (continued)

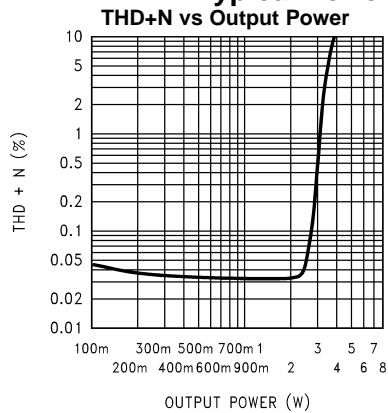

Figure 17. $V_{DD} = 12V$, $R_L = 4\Omega$, SE operation, both channels driven and loaded (average shown), $f_{IN} = 1kHz$

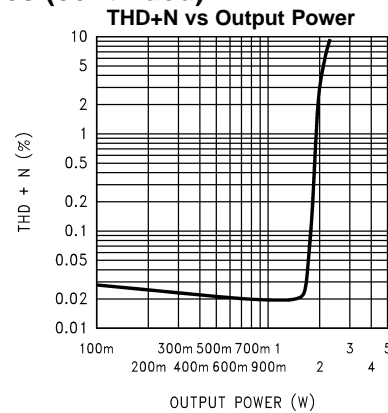

Figure 18. $V_{DD} = 12V$, $R_L = 8\Omega$, SE operation, both channels driven and loaded (average shown), $f_{IN} = 1kHz$

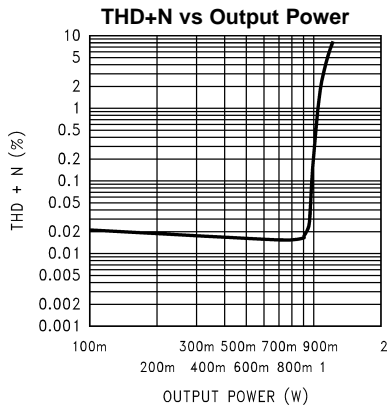

Figure 19. $V_{DD} = 12V$, $R_L = 16\Omega$, SE operation, both channels driven and loaded (average shown), $f_{IN} = 1kHz$

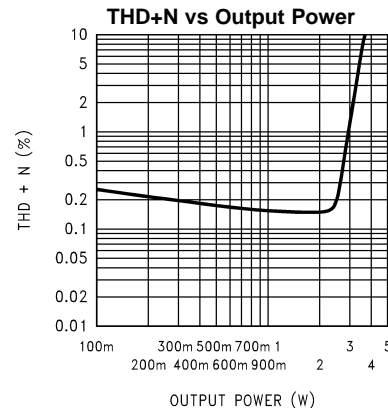

Figure 20. $V_{DD} = 12V$, $R_L = 4\Omega$, SE operation, $A_V = 10$, both channels driven and loaded (average shown), $f_{IN} = 1kHz$

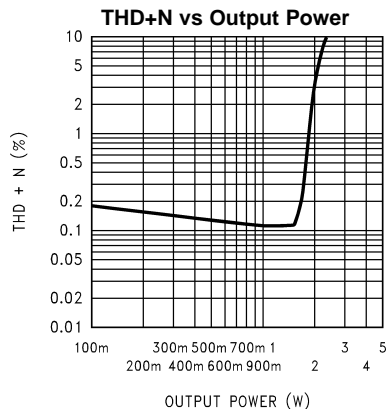

Figure 21. $V_{DD} = 12V$, $R_L = 8\Omega$, SE operation, $A_V = 10$, both channels driven and loaded (average shown), $f_{IN} = 1kHz$

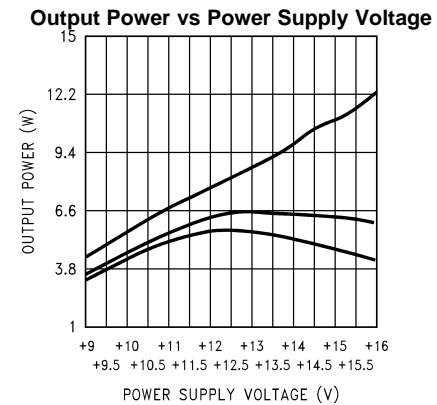

Figure 22. $R_L = 8\Omega$, BTL, $f_{IN} = 1kHz$, at (from top to bottom at 12V): THD+N = 10% THD+N = 1%, THD+N = 0.2%

Typical Performance Characteristics (continued)

Output Power vs Power Supply Voltage

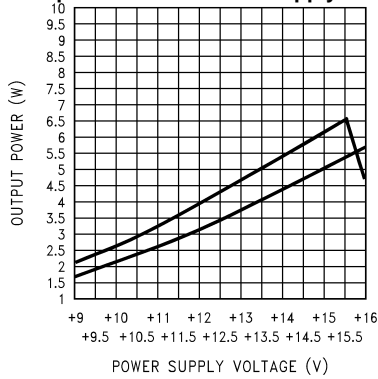

Figure 23. $R_L = 4\Omega$, SE operation, both channels driven and loaded (average shown), at (from top to bottom at 12V): THD+N = 10%, THD+N = 1%

Output Power vs Power Supply Voltage

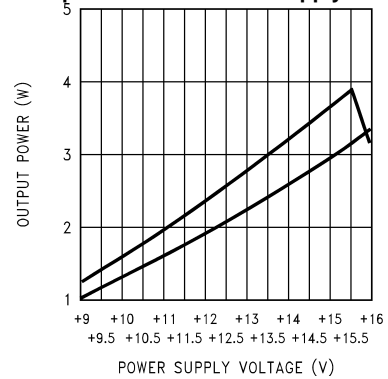

Figure 24. $R_L = 8\Omega$, SE operation, $f_{IN} = 1\text{kHz}$, both channels driven and loaded (average shown), at (from top to bottom at 12V): THD+N = 10%, THD+N = 1%

Power Supply Rejection vs Frequency

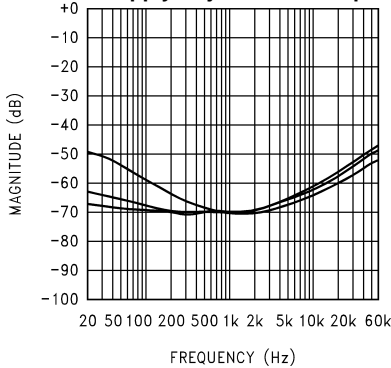

Figure 25. $V_{DD} = 12\text{V}$, $R_L = 8\Omega$, BTL operation, $V_{RIPPLE} = 200\text{mV}_{p-p}$, at (from top to bottom at 60Hz): $C_{BYPASS} = 1\mu\text{F}$, $C_{BYPASS} = 4.7\mu\text{F}$, $C_{BYPASS} = 10\mu\text{F}$

Power Supply Rejection vs Frequency

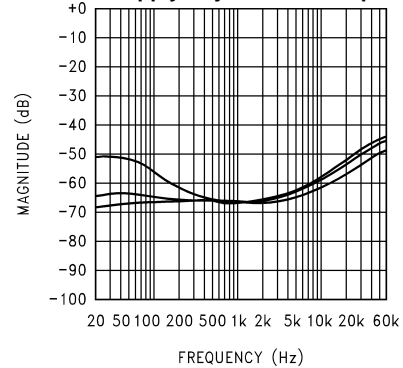

Figure 26. $V_{DD} = 12\text{V}$, $R_L = 8\Omega$, SE operation, $V_{RIPPLE} = 200\text{mV}_{p-p}$, at (from top to bottom at 60Hz): $C_{BYPASS} = 1\mu\text{F}$, $C_{BYPASS} = 4.7\mu\text{F}$, $C_{BYPASS} = 10\mu\text{F}$

Power Supply Rejection vs Frequency

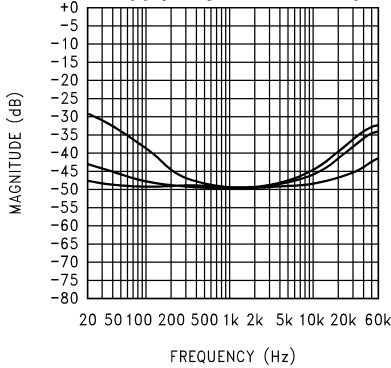

Figure 27. $V_{DD} = 12\text{V}$, $R_L = 8\Omega$, BTL operation, $V_{RIPPLE} = 200\text{mV}_{p-p}$, $A_V = 20$, at (from top to bottom at 60Hz): $C_{BYPASS} = 1\mu\text{F}$, $C_{BYPASS} = 4.7\mu\text{F}$, $C_{BYPASS} = 10\mu\text{F}$

Power Supply Rejection vs Frequency

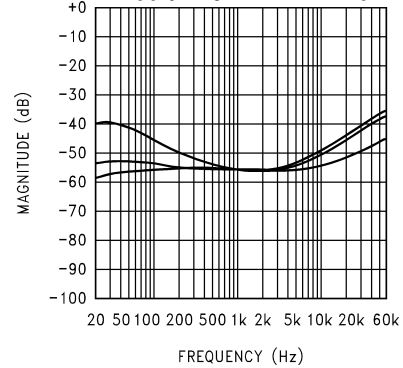

Figure 28. $V_{DD} = 12\text{V}$, $R_L = 8\Omega$, SE operation, $V_{RIPPLE} = 200\text{mV}_{p-p}$, $A_V = 10$, at (from top to bottom at 60Hz): $C_{BYPASS} = 1\mu\text{F}$, $C_{BYPASS} = 4.7\mu\text{F}$, $C_{BYPASS} = 10\mu\text{F}$

Typical Performance Characteristics (continued)

Total Power Dissipation vs Load Dissipation

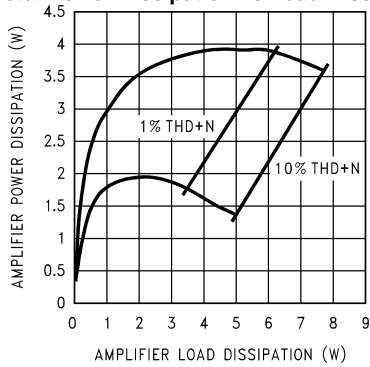

Figure 29. $V_{DD} = 12V$, BTL operation, $f_{IN} = 1kHz$, at (from top to bottom at 3W): $R_L = 8\Omega$, $R_L = 16\Omega$

Total Power Dissipation vs Load Dissipation

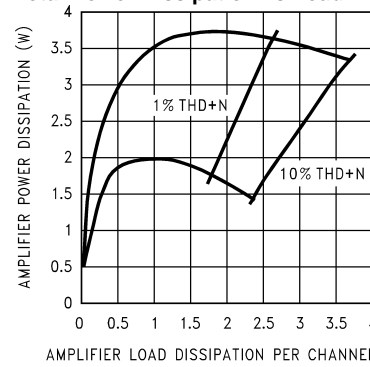

Figure 30. $V_{DD} = 12V$, SE operation, $f_{IN} = 1kHz$, at (from top to bottom at 1W): $R_L = 4\Omega$, $R_L = 8\Omega$

Output Power vs Load Resistance

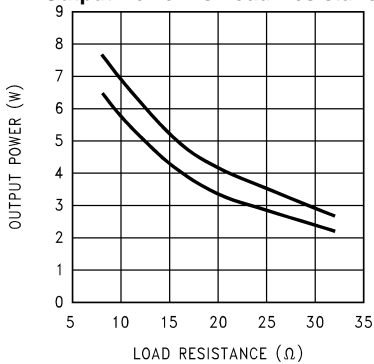

Figure 31. $V_{DD} = 12V$, BTL operation, $f_{IN} = 1kHz$, at (from top to bottom at 15Ω): THD+N = 10%, THD+N = 1%

Output Power vs Load Resistance

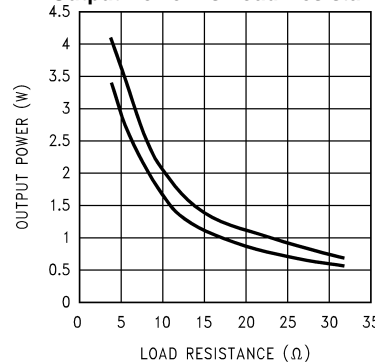

Figure 32. $V_{DD} = 12V$, SE operation, $f_{IN} = 1kHz$, both channels driven and loaded, at (from top to bottom at 15Ω): THD+N = 10%, THD+N = 1%

Channel-to-Channel Crosstalk vs Frequency

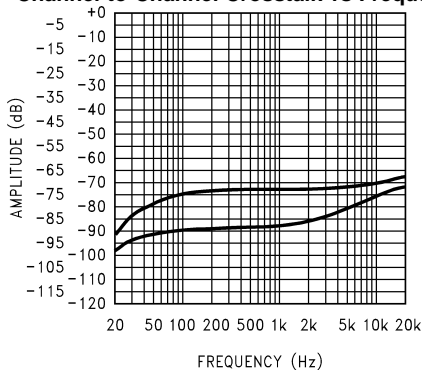

Figure 33. $V_{DD} = 12V$, $R_L = 4\Omega$, $P_{OUT} = 1W$, SE operation, V_{OUTA} measured; V_{INA} driven, V_{OUTB} measured

Channel-to-Channel Crosstalk vs Frequency

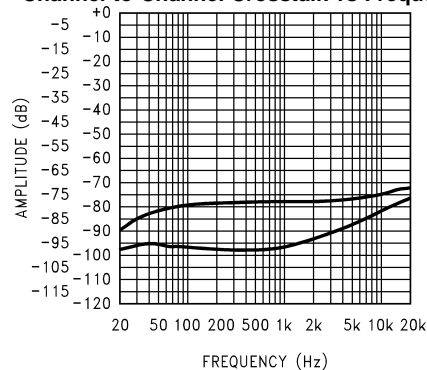

Figure 34. $V_{DD} = 12V$, $R_L = 8\Omega$, $P_{OUT} = 1W$, SE operation, at (from top to bottom at 1kHz): V_{INB} driven, V_{OUTA} measured; V_{INA} driven, V_{OUTB} measured

Typical Performance Characteristics (continued)

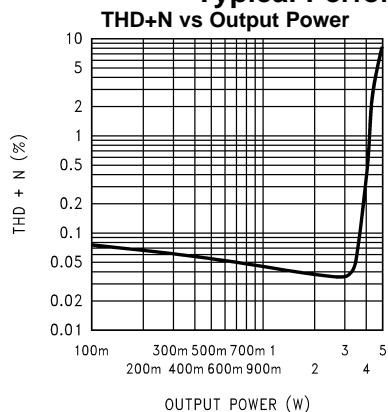

Figure 35. $V_{DD} = 9.6V$, $R_L = 8\Omega$, BTL operation, $f_{IN} = 1kHz$

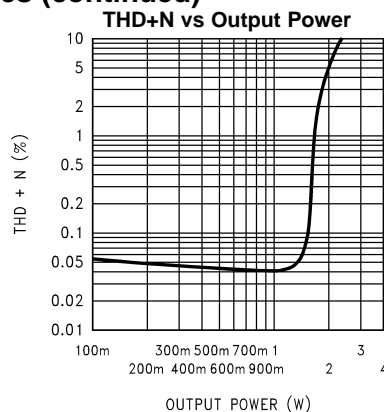

Figure 36. $V_{DD} = 9.6V$, $R_L = 4\Omega$, SE operation, $f_{IN} = 1kHz$ both channels driven and loaded (average shown)

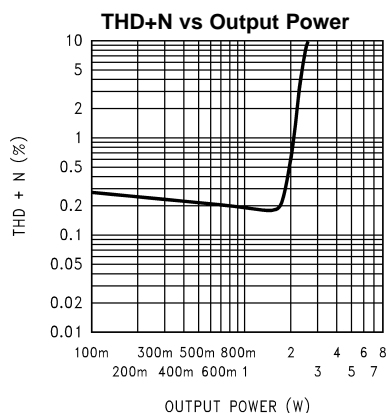

Figure 37. $V_{DD} = 9.6V$, $R_L = 8\Omega$, BTL operation, $BTLA_V = 20$, $f_{IN} = 1kHz$

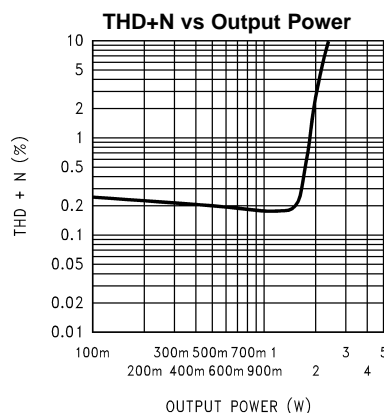

Figure 38. $V_{DD} = 9.6V$, $R_L = 4\Omega$, SE operation, $AV = 10$, $f_{IN} = 1kHz$ both channels driven and loaded (average shown)

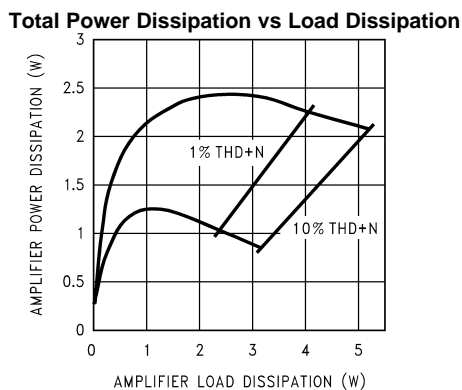

Figure 39. $V_{DD} = 9.6V$, BTL operation, $f_{IN} = 1kHz$ at (from top to bottom at 2W): $R_L = 8\Omega$, $R_L = 16\Omega$

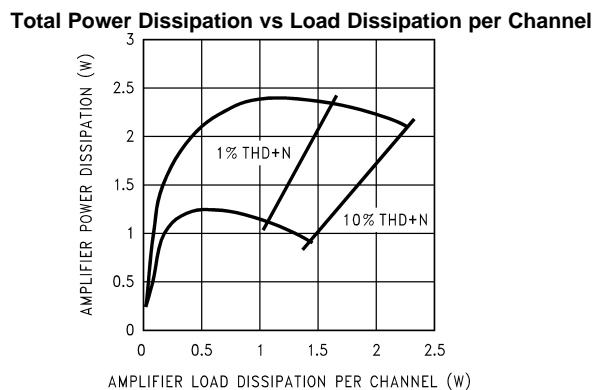

Figure 40. $V_{DD} = 9.6V$, SE operation, $f_{IN} = 1kHz$, at (from top to bottom at 1W): $R_L = 4\Omega$, $R_L = 8\Omega$

Typical Performance Characteristics (continued)

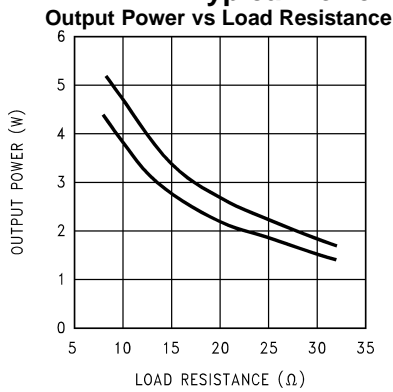

Figure 41. $V_{DD} = 9.6V$, BTL operation, $f_{IN} = 1kHz$, at (from top to bottom at 15 Ω): THD+N = 10%, THD+N = 1%

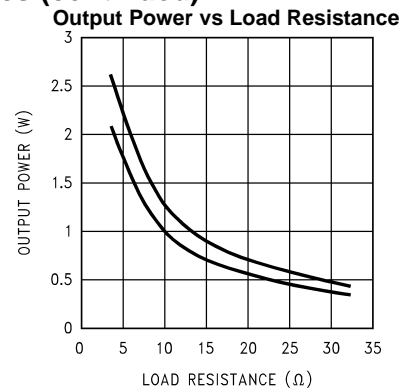

Figure 42. $V_{DD} = 9.6V$, SE operation, $f_{IN} = 1kHz$, both channels driven and loaded, at (from top to bottom at 15 Ω): THD+N = 10%, THD+N = 1%

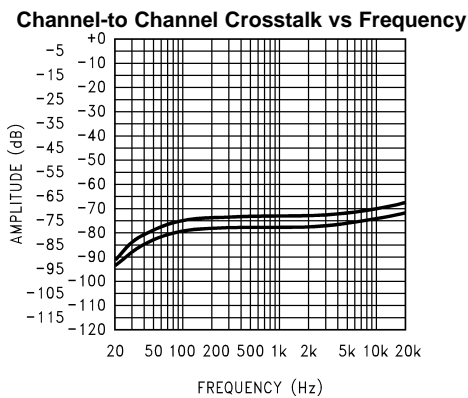

Figure 43. $V_{DD} = 9.6V$, $R_L = 4\Omega$, $P_{OUT} = 1W$, SE operation, at (from top to bottom at 1kHz): V_{INB} driven, V_{OUTA} measured; V_{INA} driven, V_{OUTB} measured

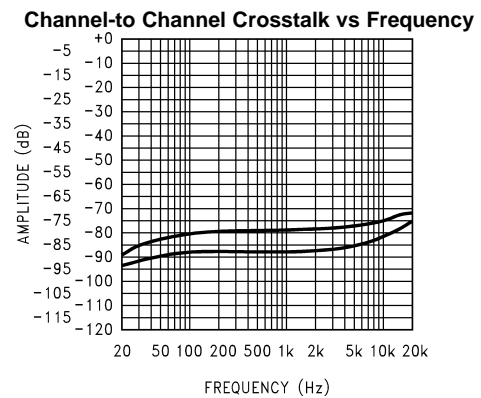

Figure 44. $V_{DD} = 9.6V$, $R_L = 8\Omega$, $P_{OUT} = 1W$, SE operation, at (from top to bottom at 1kHz): V_{INB} driven, V_{OUTA} measured; V_{INA} driven, V_{OUTB} measured

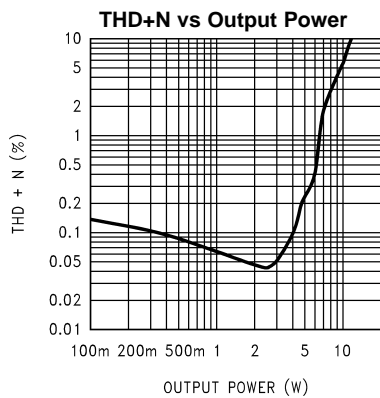

Figure 45. $V_{DD} = 15V$, $R_L = 8\Omega$, BTL operation, $f_{IN} = 1kHz$

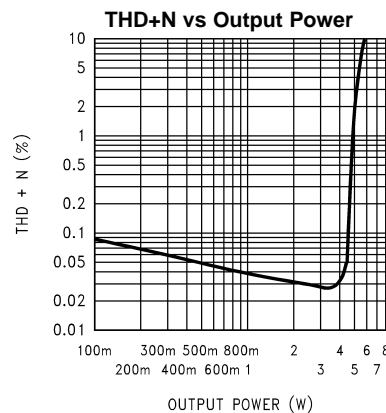

Figure 46. $V_{DD} = 15V$, $R_L = 4\Omega$, SE operation, $f_{IN} = 1kHz$ both channels driven and loaded (average shown)

Typical Performance Characteristics (continued)

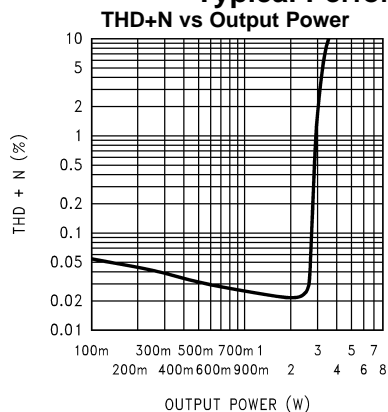

Figure 47. $V_{DD} = 15V$, $R_L = 8\Omega$, SE operation, $f_{IN} = 1kHz$, both channels driven and loaded (average shown)

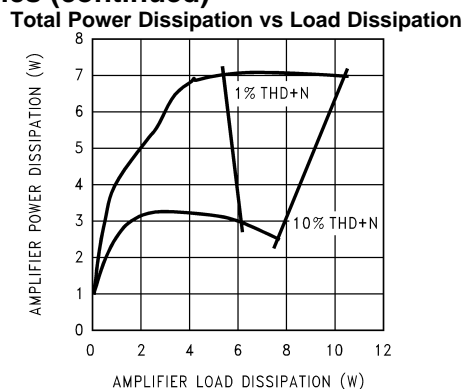

Figure 48. $V_{DD} = 15V$, BTL operation, $f_{IN} = 1kHz$, at (from top to bottom at 4W): $R_L = 8\Omega$, $R_L = 16\Omega$

Total Power Dissipation vs Load Dissipation per Channel

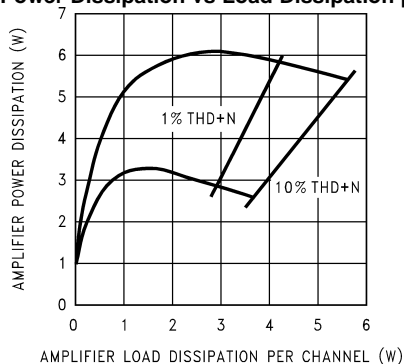

Figure 49. $V_{DD} = 15V$, SE operation, $f_{IN} = 1kHz$, at (from top to bottom at 2W): $R_L = 4\Omega$, $R_L = 8\Omega$

Output Power vs Load Resistance

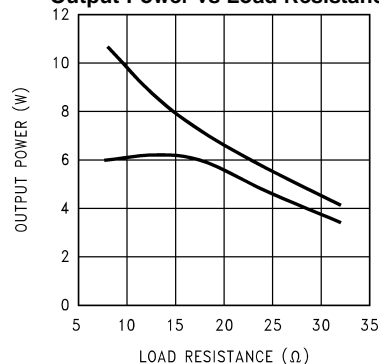

Figure 50. $V_{DD} = 15V$, BTL operation, $f_{IN} = 1kHz$, at (from top to bottom at 15Ω): THD+N = 10%, THD+N = 1%

Output Power vs Load Resistance

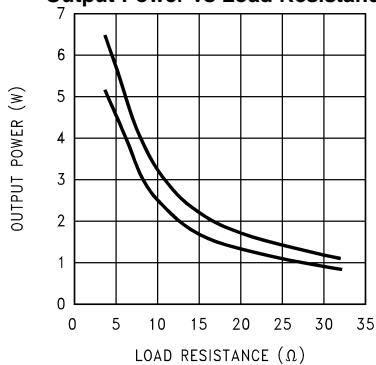

Figure 51. $V_{DD} = 15V$, SE operation, $f_{IN} = 1kHz$, both channels driven and loaded, at (from top to bottom at 15Ω): THD+N = 10%, THD+N = 1%

THD+N vs Output Power

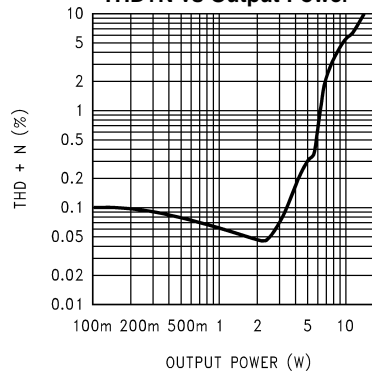

Figure 52. $V_{DD} = 16V$, $R_L = 8\Omega$, BTL operation, $f_{IN} = 1kHz$

Typical Performance Characteristics (continued)

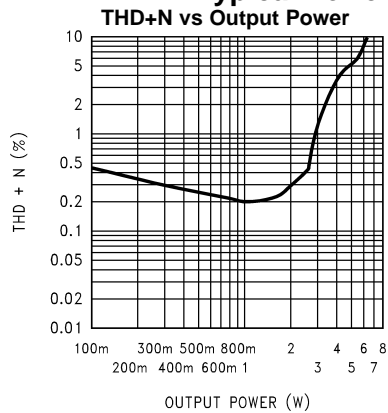

Figure 53. $V_{DD} = 16V$, $R_L = 8\Omega$, BTL operation, $f_{IN} = 1kHz$, $BTLA_V = 20$

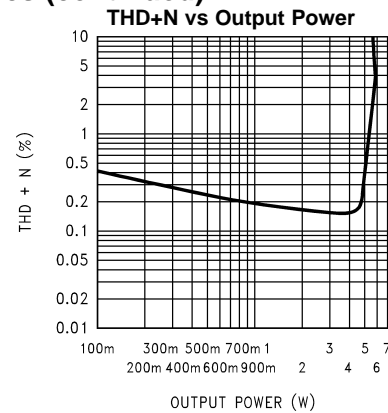

Figure 54. $V_{DD} = 16V$, $R_L = 4\Omega$, $A_V = 10$ SE operation, $f_{IN} = 1kHz$, both channels driven and loaded (average shown)

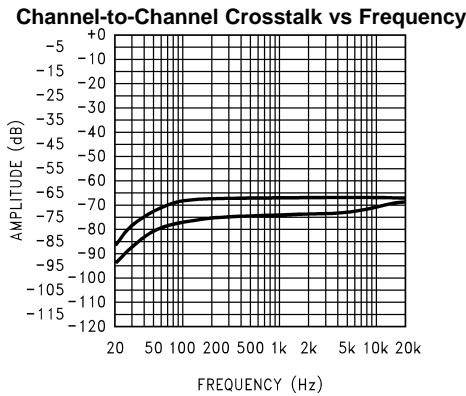

Figure 55. $V_{DD} = 16V$, $R_L = 4\Omega$, $P_{OUT} = 1W$, SE operation at (from top to bottom at 1kHz): V_{INB} driven, V_{OUTA} measured; V_{INA} driven, V_{OUTB} measured

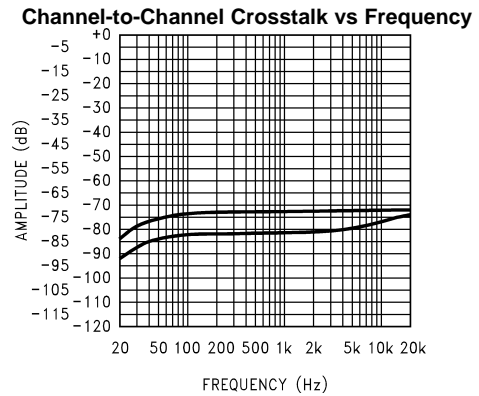

Figure 56. $V_{DD} = 16V$, $R_L = 8\Omega$, $P_{OUT} = 1W$, SE operation at (from top to bottom at 1kHz): V_{INB} driven, V_{OUTA} measured; V_{INA} driven, V_{OUTB} measured

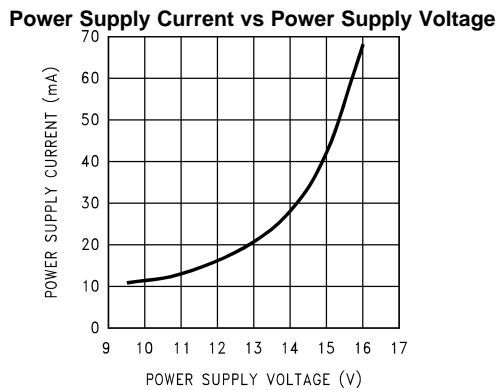

Figure 57. $R_L = 8\Omega$, BTL operation $V_{IN} = 0V$, $R_{SOURCE} = 50\Omega$

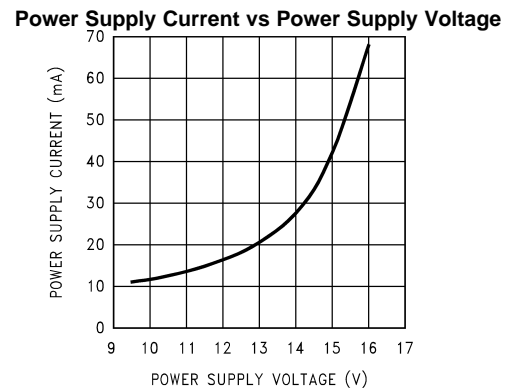

Figure 58. $R_L = 4\Omega$, SE operation $V_{IN} = 0V$, $R_{SOURCE} = 50\Omega$

Typical Performance Characteristics (continued)

Clipping Voltage vs Power Supply Voltage

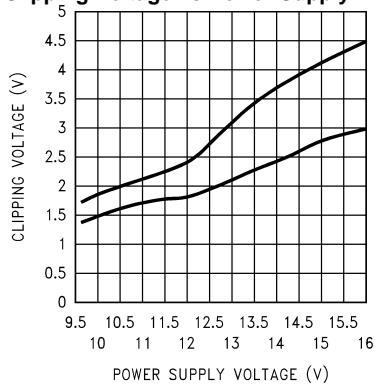

Figure 59. $R_L = 8\Omega$, BTL operation, $f_{IN} = 1\text{kHz}$ at (from top to bottom at 12V): positive signal swing, negative signal swing

Clipping Voltage vs Power Supply Voltage

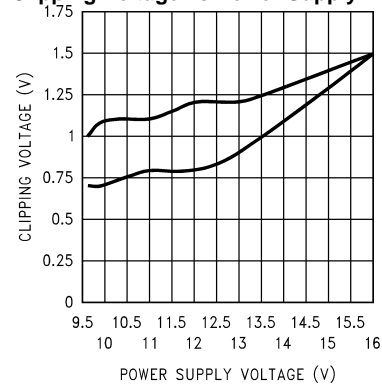

Figure 60. $R_L = 16\Omega$, BTL operation, $f_{IN} = 1\text{kHz}$ at (from top to bottom at 12V): positive signal swing, negative signal swing

Clipping Voltage vs Power Supply Voltage

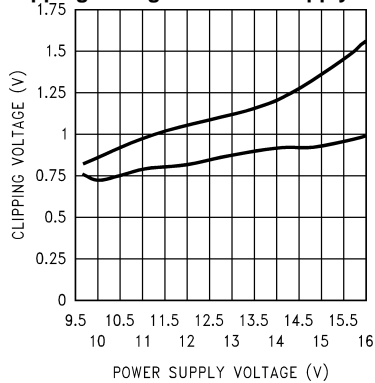

Figure 61. $R_L = 8\Omega$, SE operation, $f_{IN} = 1\text{kHz}$ both channels driven and loaded, at (from top to bottom at 13V): negative signal swing, positive signal swing

Clipping Voltage vs Power Supply Voltage

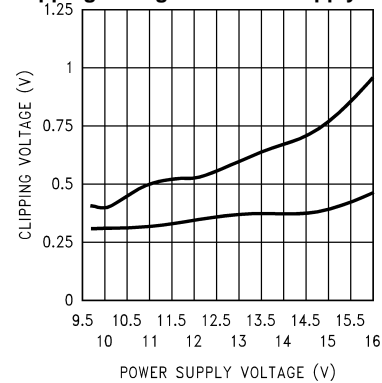

Figure 62. $R_L = 8\Omega$, SE operation, $f_{IN} = 1\text{kHz}$ both channels driven and loaded, at (from top to bottom at 13V): negative signal swing, positive signal swing

Power Dissipation vs Ambient Temperature

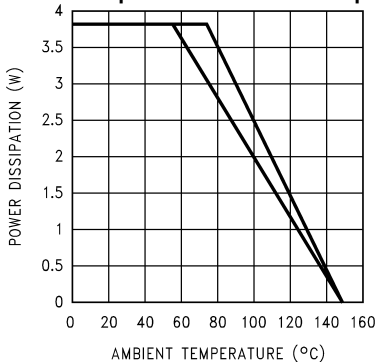

Figure 63. $V_{DD} = 12\text{V}$, $R_L = 8\Omega$ (BTL), $f_{IN} = 1\text{kHz}$, (from top to bottom at 80°C): 16in² copper plane heatsink area, 8in² copper plane heatsink area

Power Dissipation vs Ambient Temperature

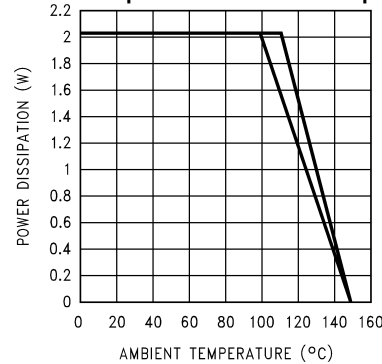

Figure 64. $V_{DD} = 12\text{V}$, $R_L = 8\Omega$ (SE), $f_{IN} = 1\text{kHz}$, (from top to bottom at 120°C): 16in² copper plane heatsink area, 8in² copper plane heatsink area

APPLICATION INFORMATION

HIGH VOLTAGE BOOMER WITH INCREASED OUTPUT POWER

Unlike previous 5V Boomer amplifiers, the LM4950 is designed to operate over a power supply voltages range of 9.6V to 16V. Operating on a 12V power supply, the LM4950 will deliver 7.5W into an 8Ω BTL load with no more than 10% THD+N.

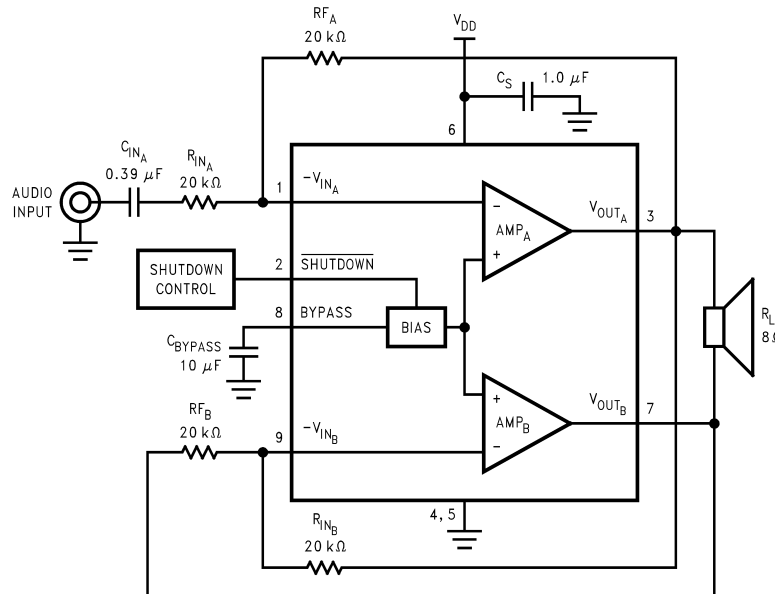

Figure 65. Typical LM4950 BTL Application Circuit

BRIDGE CONFIGURATION EXPLANATION

As shown in [Figure 65](#), the LM4950 consists of two operational amplifiers that drive a speaker connected between their outputs. The value of external input and feedback resistors determine the gain of each amplifier. Resistors R_{IN_A} and R_{F_A} set the closed-loop gain of AMP_A, whereas two 20kΩ resistors set AMP_B's gain to -1. The LM4950 drives a load, such as a speaker, connected between the two amplifier outputs, V_{OUT_A} and V_{OUT_B} . [Figure 65](#) shows that AMP_A's output serves as AMP_B's input. This results in both amplifiers producing signals identical in magnitude, but 180° out of phase. Taking advantage of this phase difference, a load is placed between AMP_A and AMP_B and driven differentially (commonly referred to as "bridge mode"). This results in a differential, or BTL, gain of

$$A_{VD} = 2(R_f / R_i) \quad (1)$$

Bridge mode amplifiers are different from single-ended amplifiers that drive loads connected between a single amplifier's output and ground. For a given supply voltage, bridge mode has a distinct advantage over the single-ended configuration: its differential output doubles the voltage swing across the load. Theoretically, this produces four times the output power when compared to a single-ended amplifier under the same conditions. This increase in attainable output power assumes that the amplifier is not current limited and that the output signal is not clipped. To ensure minimum output signal clipping when choosing an amplifier's closed-loop gain, refer to [AUDIO POWER AMPLIFIER DESIGN](#).

Another advantage of the differential bridge output is no net DC voltage across the load. This is accomplished by biasing AMP1's and AMP2's outputs at half-supply. This eliminates the coupling capacitor that single supply, single-ended amplifiers require. Eliminating an output coupling capacitor in a typical single-ended configuration forces a single-supply amplifier's half-supply bias voltage across the load. This increases internal IC power dissipation and may permanently damage loads such as speakers.

POWER DISSIPATION

Power dissipation is a major concern when designing a successful single-ended or bridged amplifier. [Equation 2](#) states the maximum power dissipation point for a single-ended amplifier operating at a given supply voltage and driving a specified output load.

$$P_{\text{DMAX-SE}} = (V_{\text{DD}})^2 / (2\pi^2 R_L): \text{ Single Ended} \quad (2)$$

The LM4950's dissipation is twice the value given by [Equation 2](#) when driving two SE loads. For a 12V supply and two 8Ω SE loads, the LM4950's dissipation is 1.82W.

The LM4950's dissipation when driving a BTL load is given by [Equation 3](#). For a 12V supply and a single 8Ω BTL load, the dissipation is 3.65W.

$$P_{\text{DMAX-MONOBTL}} = 4(V_{\text{DD}})^2 / 2\pi^2 R_L: \text{ Bridge Mode} \quad (3)$$

The maximum power dissipation point given by [Equation 3](#) must not exceed the power dissipation given by [Equation 4](#):

$$P_{\text{DMAX}'} = (T_{\text{JMAX}} - T_A) / \theta_{\text{JA}} \quad (4)$$

The LM4950's $T_{\text{JMAX}} = 150^\circ\text{C}$. In the KTW package, the LM4950's θ_{JA} is 20°C/W when the metal tab is soldered to a copper plane of at least 16in^2 . This plane can be split between the top and bottom layers of a two-sided PCB. Connect the two layers together under the tab with a 5x5 array of vias. For the NEC package, use an external heatsink with a thermal impedance that is less than 20°C/W . At any given ambient temperature T_A , use [Equation 4](#) to find the maximum internal power dissipation supported by the IC packaging. Rearranging [Equation 4](#) and substituting P_{DMAX} for $P_{\text{DMAX}'}$ results in [Equation 5](#). This equation gives the maximum ambient temperature that still allows maximum stereo power dissipation without violating the LM4950's maximum junction temperature.

$$T_A = T_{\text{JMAX}} - P_{\text{DMAX-MONOBTL}}\theta_{\text{JA}} \quad (5)$$

For a typical application with a 12V power supply and a BTL 8Ω load, the maximum ambient temperature that allows maximum stereo power dissipation without exceeding the maximum junction temperature is approximately 77°C for the KTW package.

$$T_{\text{JMAX}} = P_{\text{DMAX-MONOBTL}}\theta_{\text{JA}} + T_A \quad (6)$$

[Equation 6](#) gives the maximum junction temperature T_{JMAX} . If the result violates the LM4950's 150°C , reduce the maximum junction temperature by reducing the power supply voltage or increasing the load resistance. Further allowance should be made for increased ambient temperatures.

The above examples assume that a device is operating around the maximum power dissipation point. Since internal power dissipation is a function of output power, higher ambient temperatures are allowed as output power or duty cycle decreases.

If the result of [Equation 3](#) is greater than that of [Equation 4](#), then decrease the supply voltage, increase the load impedance, or reduce the ambient temperature. Further, ensure that speakers rated at a nominal 4Ω (SE operation) or 8Ω (BTL operation) do not fall below 3Ω or 6Ω, respectively. If these measures are insufficient, a heat sink can be added to reduce θ_{JA} . The heat sink can be created using additional copper area around the package, with connections to the ground pins, supply pin and amplifier output pins. Refer to the [Typical Performance Characteristics](#) curves for power dissipation information at lower output power levels.

POWER SUPPLY VOLTAGE LIMITS

Continuous proper operation is ensured by never exceeding the voltage applied to any pin, with respect to ground, as listed in [Absolute Maximum Ratings](#) section.

POWER SUPPLY BYPASSING

As with any power amplifier, proper supply bypassing is critical for low noise performance and high power supply rejection. Applications that employ a voltage regulator typically use a $10\mu\text{F}$ in parallel with a $0.1\mu\text{F}$ filter capacitors to stabilize the regulator's output, reduce noise on the supply line, and improve the supply's transient response. However, their presence does not eliminate the need for a local $1.0\mu\text{F}$ tantalum bypass capacitance connected between the LM4950's supply pins and ground. Do not substitute a ceramic capacitor for the tantalum. Doing so may cause oscillation. Keep the length of leads and traces that connect capacitors between the LM4950's power supply pin and ground as short as possible. Connecting a $10\mu\text{F}$ capacitor, C_{BYPASS} , between

the BYPASS pin and ground improves the internal bias voltage's stability and improves the amplifier's PSRR. The PSRR improvements increase as the bypass pin capacitor value increases. Too large, however, increases turn-on time and can compromise the amplifier's click and pop performance. The selection of bypass capacitor values, especially C_{BYPASS} , depends on desired PSRR requirements, click and pop performance (as explained in [SELECTING EXTERNAL COMPONENTS](#)), system cost, and size constraints.

MICRO-POWER SHUTDOWN

The LM4950 features an active-low micro-power shutdown mode. When active, the LM4950's micro-power shutdown feature turns off the amplifier's bias circuitry, reducing the supply current. The low 40 μA typical shutdown current is achieved by applying a voltage to the SHUTDOWN pin that is as near to GND as possible. A voltage that is greater than GND may increase the shutdown current.

There are a few methods to control the micro-power shutdown. These include using a single-pole, single-throw switch (SPST), a microprocessor, or a microcontroller. When using a switch, connect a 100k Ω pull-up resistor between the SHUTDOWN pin and V_{DD} and a second 100k Ω resistor in parallel with the SPST switch connected between the SHUTDOWN pin and GND. The two resistors form a voltage divider that ensures that the voltage applied to the SHUTDOWN pin does not exceed $V_{\text{DD}}/2$. Select normal amplifier operation by opening the switch. Closing the switch applies GND to the SHUTDOWN pin, activating micro-power shutdown. The switch and resistor ensure that the SHUTDOWN pin will not float. This prevents unwanted state changes. In a system with a microprocessor or a microcontroller, use a digital output to apply the active-state voltage to the SHUTDOWN pin. Again, ensure that the microcontroller or microprocessor logic-high signal does not exceed the LM4950's $V_{\text{DD}}/2$ SHUTDOWN signal limit.

SELECTING EXTERNAL COMPONENTS

Input Capacitor Value Selection

Two quantities determine the value of the input coupling capacitor: the lowest audio frequency that requires amplification and desired output transient suppression.

As shown in [Figure 65](#), the input resistor (R_{IN}) and the input capacitor (C_{IN}) produce a high pass filter cutoff frequency that is found using [Equation 7](#).

$$f_c = 1/2\pi R_i C_i \quad (7)$$

As an example when using a speaker with a low frequency limit of 50Hz, C_i , using [Equation 7](#) is 0.159 μF . The 0.39 μF C_{INA} shown in [Figure 65](#) allows the LM4950 to drive high efficiency, full range speaker whose response extends below 30Hz.

Bypass Capacitor Value

Besides minimizing the input capacitor size, careful consideration should be paid to value of C_{BYPASS} , the capacitor connected to the BYPASS pin. Since C_{BYPASS} determines how fast the LM4950 settles to quiescent operation, its value is critical when minimizing turn-on pops. The slower the LM4950's outputs ramp to their quiescent DC voltage (nominally $V_{\text{DD}}/2$), the smaller the turn-on pop. Choosing C_{BYPASS} equal to 10 μF along with a small value of C_{IN} (in the range of 0.1 μF to 0.39 μF), produces a click-less and pop-less shutdown function. As discussed above, choosing C_{IN} no larger than necessary for the desired bandwidth helps minimize clicks and pops.

OPTIMIZING CLICK AND POP REDUCTION PERFORMANCE

The LM4950 contains circuitry that eliminates turn-on and shutdown transients ("clicks and pops"). For this discussion, turn-on refers to either applying the power supply voltage or when the micro-power shutdown mode is deactivated.

As the $V_{\text{DD}}/2$ voltage present at the BYPASS pin ramps to its final value, the LM4950's internal amplifiers are configured as unity gain buffers and are disconnected from the AMP_A and AMP_B pins. An internal current source charges the capacitor connected between the BYPASS pin and GND in a controlled manner. Ideally, the input and outputs track the voltage applied to the BYPASS pin. The gain of the internal amplifiers remains unity until the voltage applied to the BYPASS pin.

The gain of the internal amplifiers remains unity until the voltage on the bypass pin reaches $V_{DD}/2$. As soon as the voltage on the bypass pin is stable, the device becomes fully operational and the amplifier outputs are reconnected to their respective output pins. Although the BYPASS pin current cannot be modified, changing the size of C_{BYPASS} alters the device's turn-on time. Here are some typical turn-on times for various values of C_{BYPASS} :

C_B (μ F)	T_{ON} (ms)
1.0	120
2.2	120
4.7	200
10	440

In order to eliminate "clicks and pops", all capacitors must be discharged before turn-on. Rapidly switching V_{DD} may not allow the capacitors to fully discharge, which may cause "clicks and pops".

There is a relationship between the value of C_{IN} and C_{BYPASS} that ensures minimum output transient when power is applied or the shutdown mode is deactivated. Best performance is achieved by setting the time constant created by C_{IN} and $R_i + R_f$ to a value less than the turn-on time for a given value of C_{BYPASS} as shown in the table above.

DRIVING PIEZO-ELECTRIC SPEAKER TRANSDUCERS

The LM4950 is able to drive capacitive piezo-electric transducer loads that are less than equal to 200nF. Stable operation is assured by placing 33pF capacitors in parallel with the 20k Ω feedback resistors. The additional capacitors are shown in [Figure 66](#).

When driving piezo-electric transducers, sound quality and acoustic power is entirely dependent upon a transducer's frequency response and efficiency. In this application, power dissipated by the LM4950 is very low, typically less than 250mW when driving a 200nF piezo-electric transducer ($V_{DD} = 12V$).

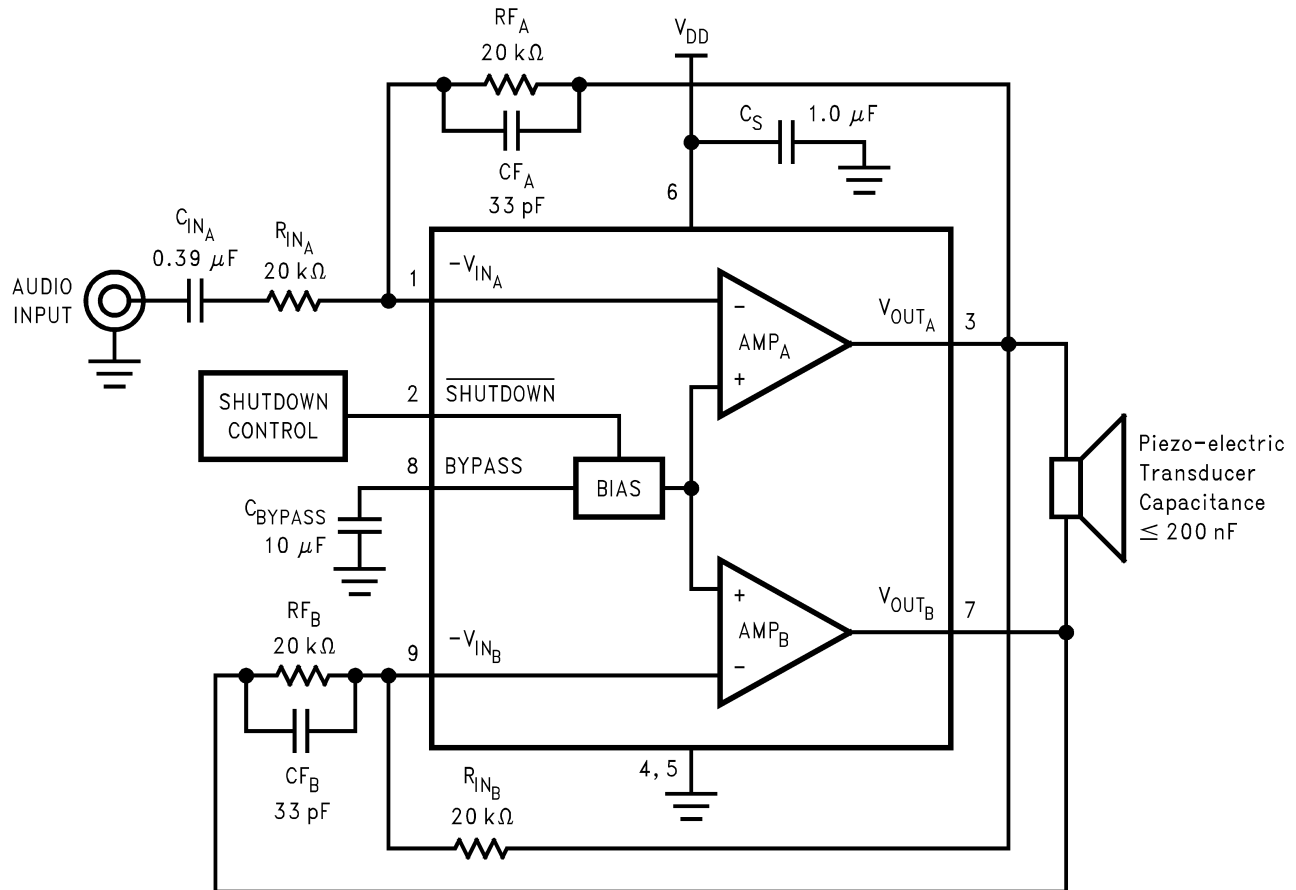

Figure 66. Piezo-electric Transducer Capacitance ≤ 200nF

AUDIO POWER AMPLIFIER DESIGN

Audio Amplifier Design: Driving 4W into an 8Ω BTL

The following are the desired operational parameters:	
Power Output	4W _{RMS}
Load Impedance	8Ω
Input Level	0.3V _{RMS} (max)
Input Impedance	20kΩ
Bandwidth	50Hz–20kHz ± 0.25dB

The design begins by specifying the minimum supply voltage necessary to obtain the specified output power. One way to find the minimum supply voltage is to use the Output Power vs Power Supply Voltage curve in [Typical Performance Characteristics](#) section. Another way, using [Equation 8](#), is to calculate the peak output voltage necessary to achieve the desired output power for a given load impedance. To account for the amplifier's dropout voltage, two additional voltages, based on the *Clipping Dropout Voltage vs Power Supply Voltage* in [Typical Performance Characteristics](#), must be added to the result obtained by [Equation 8](#). The result is [Equation 9](#).

$$V_{\text{opeak}} = \sqrt{(2R_L P_O)} \tag{8}$$

$$V_{\text{DD}} = V_{\text{OUTPEAK}} + V_{\text{ODTOP}} + V_{\text{ODBOT}} \tag{9}$$

The Output Power vs. Power Supply Voltage graph in [Typical Performance Characteristics](#) for an 8Ω load indicates a minimum supply voltage of 10.2V. The commonly used 12V supply voltage easily meets this. The additional voltage creates the benefit of headroom, allowing the LM4950 to produce peak output power in excess of 4W without clipping or other audible distortion. The choice of supply voltage must also not create a situation that violates of maximum power dissipation as explained in the [POWER DISSIPATION](#) section. After satisfying the LM4950's power dissipation requirements, the minimum differential gain needed to achieve 4W dissipation in an 8Ω BTL load is found using [Equation 10](#).

$$A_V \geq \sqrt{(P_O R_L)} / (V_{IN}) = V_{orrms} / V_{inrms} \quad (10)$$

Thus, a minimum gain of 18.9 allows the LM4950's to reach full output swing and maintain low noise and THD+N performance. For this example, let $A_{V-BTL} = 19$. The amplifier's overall BTL gain is set using the input (R_{IN_A}) and feedback (R) resistors of the first amplifier in the series BTL configuration. Additionally, A_{V-BTL} is twice the gain set by the first amplifier's R_{IN} and R_f . With the desired input impedance set at 20kΩ, the feedback resistor is found using [Equation 11](#).

$$R_f / R_{IN} = A_{V-BTL} / 2 \quad (11)$$

The value of R_f is 190kΩ (choose 191kΩ, the closest value). The nominal output power is 4W.

The last step in this design example is setting the amplifier's -3dB frequency bandwidth. To achieve the desired ±0.25dB pass band magnitude variation limit, the low frequency response must extend to at least one-fifth the lower bandwidth limit and the high frequency response must extend to at least five times the upper bandwidth limit. The gain variation for both response limits is 0.17dB, well within the ±0.25dB-desired limit. The results are an

$$f_L = 50\text{Hz} / 5 = 10\text{Hz} \quad (12)$$

and an

$$f_H = 20\text{kHz} \times 5 = 100\text{kHz} \quad (13)$$

As mentioned in [SELECTING EXTERNAL COMPONENTS](#), R_{INA} and C_{INA} create a highpass filter that sets the amplifier's lower bandpass frequency limit. Find the coupling capacitor's value using [Equation 14](#).

$$C_i = 1 / 2\pi R_{IN} f_L \quad (14)$$

The result is

$$1 / (2\pi \times 20\text{k}\Omega \times 10\text{Hz}) = 0.795\mu\text{F} \quad (15)$$

Use a 0.82μF capacitor, the closest standard value.

The product of the desired high frequency cutoff (100kHz in this example) and the differential gain A_{VD} , determines the upper passband response limit. With $A_{VD} = 7$ and $f_H = 100\text{kHz}$, the closed-loop gain bandwidth product (GBWP) is 700kHz. This is less than the LM4950's 3.5MHz GBWP. With this margin, the amplifier can be used in designs that require more differential gain while avoiding performance restricting bandwidth limitations.

RECOMMENDED PRINTED CIRCUIT BOARD LAYOUT

[Figure 67](#) through [Figure 69](#) show the recommended two-layer PC board layout that is optimized for the DDPAK-packaged, SE-configured LM4950 and associated external components. [Figure 70](#) through [Figure 72](#) show the recommended two-layer PC board layout that is optimized for the DDPAK-packaged, BTL-configured LM4950 and associated external components. These circuits are designed for use with an external 12V supply and 4Ω(min)(SE) or 8Ω(min)(BTL) speakers.

These circuit boards are easy to use. Apply 12V and ground to the board's V_{DD} and GND pads, respectively. Connect a speaker between the board's OUT_A and OUT_B outputs.

Demonstration Board Layout

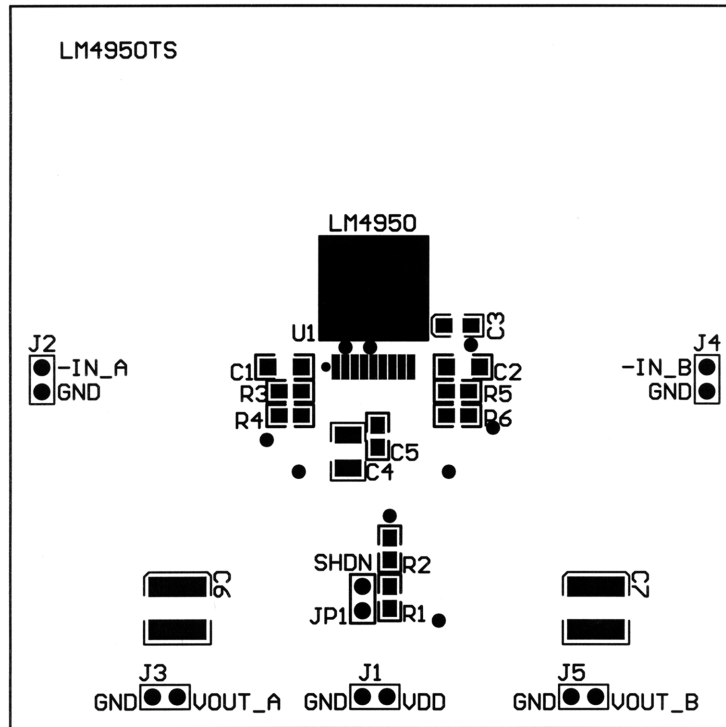

Figure 67. Recommended KTW SE PCB Layout:
Top Silkscreen

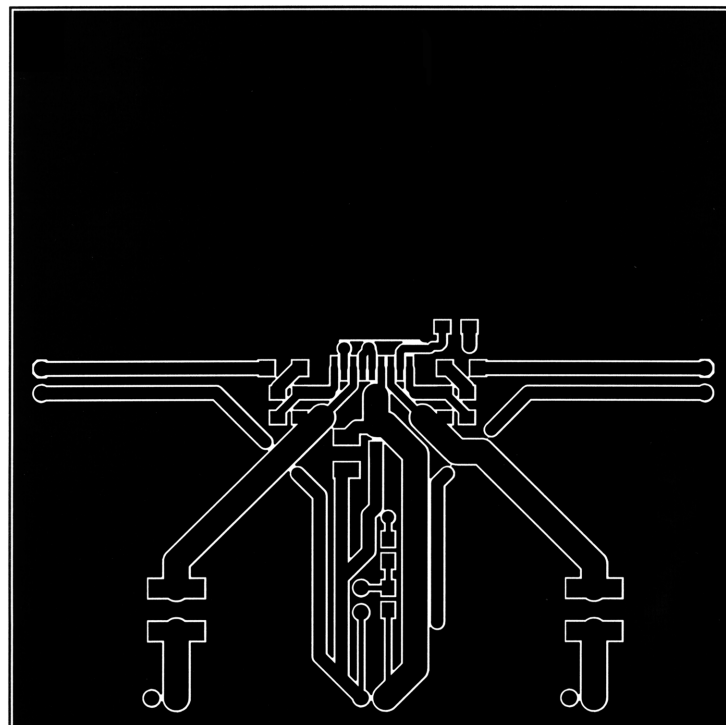

Figure 68. Recommended KTW SE PCB Layout:
Top Layer

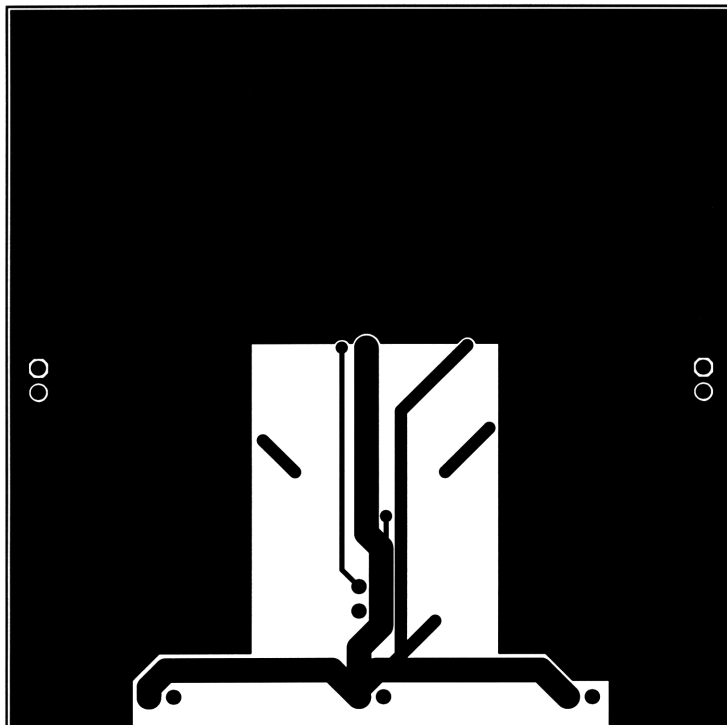

Figure 69. Recommended KTW SE PCB Layout:
Bottom Layer

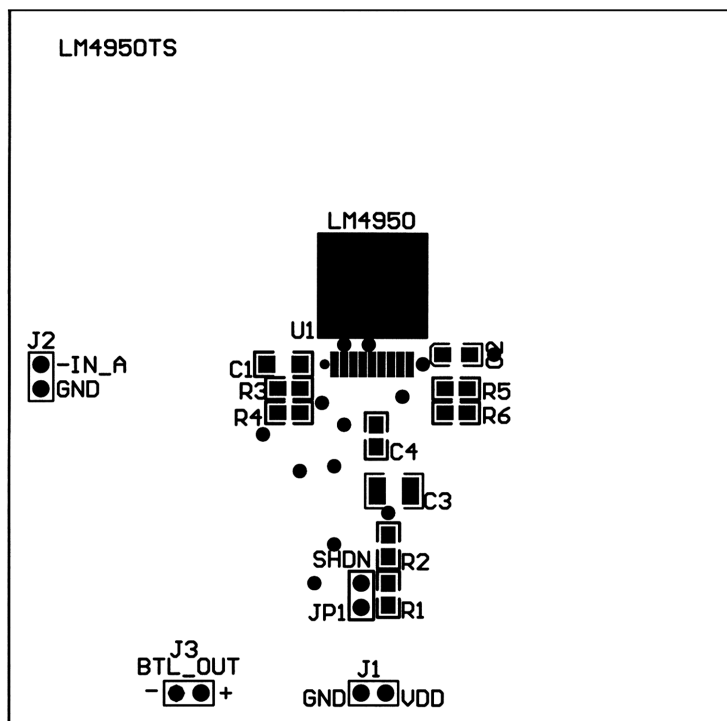
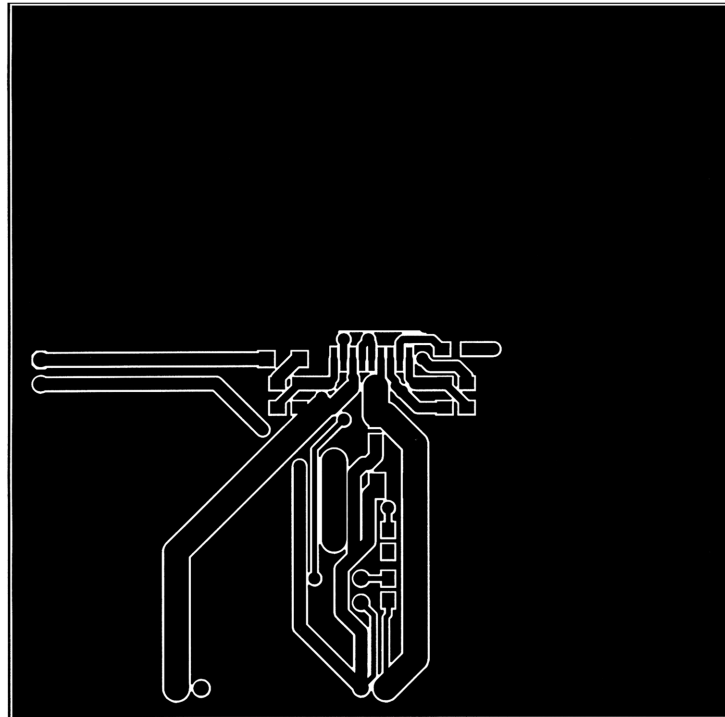
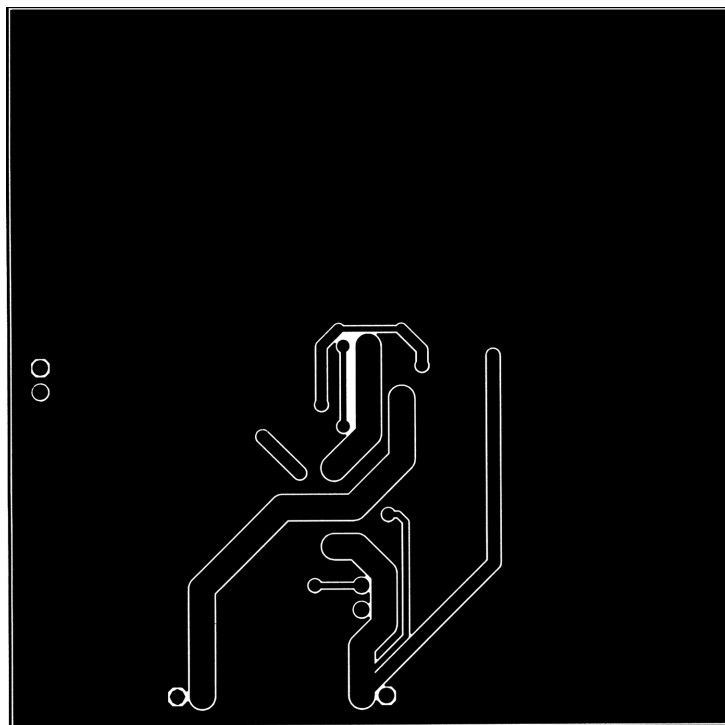

Figure 70. Recommended KTW BTL PCB Layout:
Top Silkscreen



**Figure 71. Recommended KTW BTL PCB Layout:
Top Layer**



**Figure 72. Recommended KTW BTL PCB Layout:
Bottom Layer**

REVISION HISTORY

Changes from Revision D (May 2013) to Revision E	Page
<hr/> <ul style="list-style-type: none">• Changed layout of National Data Sheet to TI format	<hr/> 24

PACKAGING INFORMATION

Orderable Device	Status (1)	Package Type	Package Drawing	Pins	Package Qty	Eco Plan (2)	Lead/Ball Finish (6)	MSL Peak Temp (3)	Op Temp (°C)	Device Marking (4/5)	Samples
LM4950TS	ACTIVE	DDPAK/ TO-263	KTW	9	45	TBD	Call TI	Call TI	-40 to 85	L4950TS	Samples
LM4950TS/NOPB	ACTIVE	DDPAK/ TO-263	KTW	9	45	Pb-Free (RoHS Exempt)	SN	Level-3-245C-168 HR	-40 to 85	L4950TS	Samples
LM4950TSX/NOPB	ACTIVE	DDPAK/ TO-263	KTW	9	500	Pb-Free (RoHS Exempt)	SN	Level-3-245C-168 HR	-40 to 85	L4950TS	Samples

(1) The marketing status values are defined as follows:

ACTIVE: Product device recommended for new designs.

LIFEBUY: TI has announced that the device will be discontinued, and a lifetime-buy period is in effect.

NRND: Not recommended for new designs. Device is in production to support existing customers, but TI does not recommend using this part in a new design.

PREVIEW: Device has been announced but is not in production. Samples may or may not be available.

OBSOLETE: TI has discontinued the production of the device.

(2) **RoHS:** TI defines "RoHS" to mean semiconductor products that are compliant with the current EU RoHS requirements for all 10 RoHS substances, including the requirement that RoHS substance do not exceed 0.1% by weight in homogeneous materials. Where designed to be soldered at high temperatures, "RoHS" products are suitable for use in specified lead-free processes. TI may reference these types of products as "Pb-Free".

RoHS Exempt: TI defines "RoHS Exempt" to mean products that contain lead but are compliant with EU RoHS pursuant to a specific EU RoHS exemption.

Green: TI defines "Green" to mean the content of Chlorine (Cl) and Bromine (Br) based flame retardants meet JS709B low halogen requirements of <=1000ppm threshold. Antimony trioxide based flame retardants must also meet the <=1000ppm threshold requirement.

(3) MSL, Peak Temp. - The Moisture Sensitivity Level rating according to the JEDEC industry standard classifications, and peak solder temperature.

(4) There may be additional marking, which relates to the logo, the lot trace code information, or the environmental category on the device.

(5) Multiple Device Markings will be inside parentheses. Only one Device Marking contained in parentheses and separated by a "-" will appear on a device. If a line is indented then it is a continuation of the previous line and the two combined represent the entire Device Marking for that device.

(6) Lead/Ball Finish - Orderable Devices may have multiple material finish options. Finish options are separated by a vertical ruled line. Lead/Ball Finish values may wrap to two lines if the finish value exceeds the maximum column width.

Important Information and Disclaimer:The information provided on this page represents TI's knowledge and belief as of the date that it is provided. TI bases its knowledge and belief on information provided by third parties, and makes no representation or warranty as to the accuracy of such information. Efforts are underway to better integrate information from third parties. TI has taken and continues to take reasonable steps to provide representative and accurate information but may not have conducted destructive testing or chemical analysis on incoming materials and chemicals. TI and TI suppliers consider certain information to be proprietary, and thus CAS numbers and other limited information may not be available for release.

In no event shall TI's liability arising out of such information exceed the total purchase price of the TI part(s) at issue in this document sold by TI to Customer on an annual basis.

TAPE AND REEL INFORMATION



QUADRANT ASSIGNMENTS FOR PIN 1 ORIENTATION IN TAPE



*All dimensions are nominal

Device	Package Type	Package Drawing	Pins	SPQ	Reel Diameter (mm)	Reel Width W1 (mm)	A0 (mm)	B0 (mm)	K0 (mm)	P1 (mm)	W (mm)	Pin1 Quadrant
LM4950TSX/NOPB	DDPAK/ TO-263	KTW	9	500	330.0	24.4	10.75	14.85	5.0	16.0	24.0	Q2

TAPE AND REEL BOX DIMENSIONS



*All dimensions are nominal

Device	Package Type	Package Drawing	Pins	SPQ	Length (mm)	Width (mm)	Height (mm)
LM4950TSX/NOPB	DDPAK/TO-263	KTW	9	500	367.0	367.0	45.0

IMPORTANT NOTICE AND DISCLAIMER

TI PROVIDES TECHNICAL AND RELIABILITY DATA (INCLUDING DATASHEETS), DESIGN RESOURCES (INCLUDING REFERENCE DESIGNS), APPLICATION OR OTHER DESIGN ADVICE, WEB TOOLS, SAFETY INFORMATION, AND OTHER RESOURCES "AS IS" AND WITH ALL FAULTS, AND DISCLAIMS ALL WARRANTIES, EXPRESS AND IMPLIED, INCLUDING WITHOUT LIMITATION ANY IMPLIED WARRANTIES OF MERCHANTABILITY, FITNESS FOR A PARTICULAR PURPOSE OR NON-INFRINGEMENT OF THIRD PARTY INTELLECTUAL PROPERTY RIGHTS.

These resources are intended for skilled developers designing with TI products. You are solely responsible for (1) selecting the appropriate TI products for your application, (2) designing, validating and testing your application, and (3) ensuring your application meets applicable standards, and any other safety, security, or other requirements. These resources are subject to change without notice. TI grants you permission to use these resources only for development of an application that uses the TI products described in the resource. Other reproduction and display of these resources is prohibited. No license is granted to any other TI intellectual property right or to any third party intellectual property right. TI disclaims responsibility for, and you will fully indemnify TI and its representatives against, any claims, damages, costs, losses, and liabilities arising out of your use of these resources.

TI's products are provided subject to TI's Terms of Sale (www.ti.com/legal/termsofsale.html) or other applicable terms available either on ti.com or provided in conjunction with such TI products. TI's provision of these resources does not expand or otherwise alter TI's applicable warranties or warranty disclaimers for TI products.

Mailing Address: Texas Instruments, Post Office Box 655303, Dallas, Texas 75265
Copyright © 2020, Texas Instruments Incorporated