

Typical unit



| Output (V) | Current (A) | Nominal Input (V)      |
|------------|-------------|------------------------|
| 3.3        | 7.575       | D48 = 36-75V (48V nom) |
| 5          | 5           |                        |
| 12         | 2.1         |                        |

## FEATURES

- 2:1 Input voltage range ( D48 = 36-75V)
- 1" x 1" x 0.41" dimensions.
- Adjustable Vout (+10% to -10%)
- High efficiency
- Positive & negative logic, remote on/off control option
- Monotonic startup into pre-bias output conditions
- Continuous short circuit protection
- Over-temperature protection
- Over-voltage protection
- Low output ripple and noise
- Strong thermal derating characteristics
- Operational temperature range -40°C to +85°C
- 1600V I/O isolation
- Packaged in a five-sided EMI shielding metal package with non-conductive base
- Certified to UL 60950-1, CAN/CSA-C22.2 No. 60950-1, IEC60950-1 safety approvals, 2nd edition, with AM1

## PRODUCT OVERVIEW

The SPM25 series isolated DC-DC converters represent the next generation in Industrial Potted Module Technology. Featuring a full 25-Watt output in one square inch of board area, the SPM25 series isolated DC-DC converter family offers efficient regulated DC power for printed circuit board mounting. The 1" x 1" x 0.41" (25.4 x 25.4 x 10.41 mm) converter accepts a 2:1 input voltage range of 36 to 75 Volts (D48), ideal for industrial applications.

Intended target markets include transportation, medical systems, electronic test equipment, industrial processing equipment, industrial applications where power modules must meet rugged environmental requirements, high power density, and

where isolated output voltages are required. These converters offer a feature/option set including: through-hole mounting, positive or negative logic (remote on/off), over-current & over-temperature protection, under-voltage lockout. The input voltage range covers the standard Industrial requirements with a regulated output voltage and power rating up to 25W.

Modules provide voltage isolation (basic insulation) from input to output of up to 1600V. The Operating ambient temperature range is -40°C to +85°C. The module delivers full output power to +70°C with no airflow. These parts are ideal for applications that do not require any heat sinking or forced air cooling.

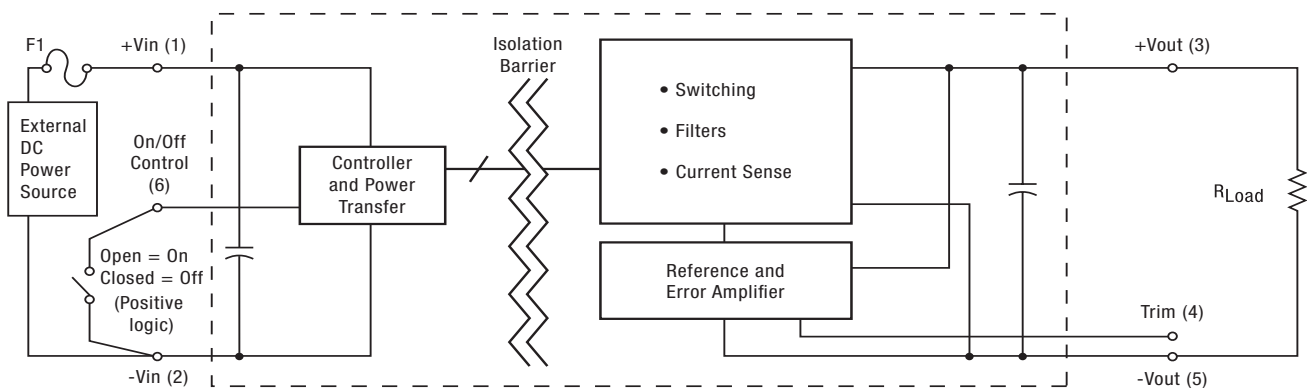

Figure 1. Connection Diagram

Typical topology is shown. Murata Power Solutions recommends an external fuse.



For full details go to  
[www.murata-ps.com/rohs](http://www.murata-ps.com/rohs)



(pending)

| PERFORMANCE SPECIFICATIONS SUMMARY AND ORDERING GUIDE ① ③ |                      |                           |                 |             |      |                   |         |                          |           |                                |                                 |            |       |                     |                     |
|---|----------------------|---------------------------|-----------------|-------------|------|-------------------|---------|--------------------------|-----------|--------------------------------|---------------------------------|------------|-------|---------------------|---------------------|
| Root Models ①   | Output               |                           |                 |             |      |                   |         | Input                    |           |                                |                                 | Efficiency |       | Dimensions          |                     |
|   | V <sub>OUT</sub> (V) | I <sub>OUT</sub> (A, max) | Total Power (W) | R/N (mVp-p) |      | Regulation (Max.) |         | V <sub>IN</sub> Nom. (V) | Range (V) | I <sub>IN</sub> , no load (mA) | I <sub>IN</sub> , full load (A) | Min.       | Typ.  | Case (inches)       | Case (mm)           |
|   |                      |                           |                 | Typ. ②      | Max. | Line              | Load    |                          |           |                                |                                 |            |       |                     |                     |
| SPM25-033-D48   | 3.3                  | 7.575                     | 25              | 50          | 80   | ±0.1%             | ±0.2%   | 48                       | 36-75     | 75                             | 0.58                            | 87%        | 89.5% | 1.0" x 1.0" x 0.41" | 25.4 x 25.4 x 10.41 |
| SPM25-050-D48   | 5                    | 5                         | 25              | 50          | 80   | ±0.1%             | ±0.2%   | 48                       | 36-75     | 30                             | 0.57                            | 88.3%      | 91.0% | 1.0" x 1.0" x 0.41" | 25.4 x 25.4 x 10.41 |
| SPM25-120-D48   | 12                   | 2.1                       | 25.2            | 65          | 120  | ±0.1%             | ±0.125% | 48                       | 36-75     | 20                             | 0.6                             | 85.0%      | 87%   | 1.0" x 1.0" x 0.41" | 25.4 x 25.4 x 10.41 |

- Notes:**
- ① Please refer to the part number structure for additional options and complete ordering part numbers.
  - ② Ripple and Noise is shown at 20 MHz bandwidth.
  - ③ All specifications are at nominal line voltage and full load, +25 °C. unless otherwise noted. See detailed specifications for full conditions. Output capacitors are 1 µF in parallel with 10 µF. The input cap is 4.7 µF (SPM25-120-D48) and 22 µF (SPM25-033-D48, SPM25-050-D48), low ESR.

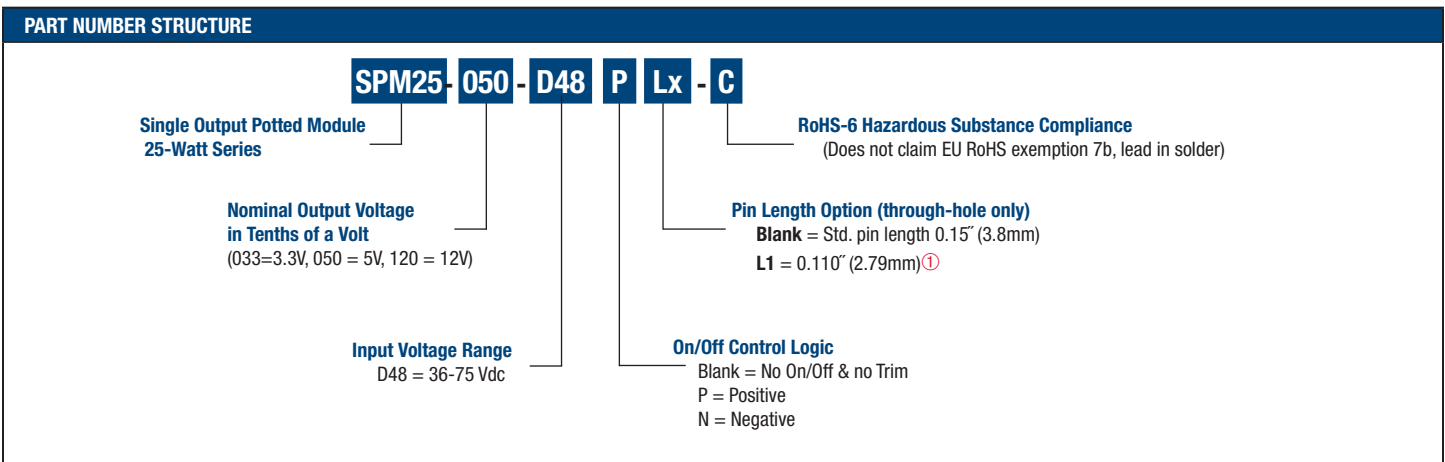

- ① **Special quantity order is required; samples available with standard pin length only.**
- ② **Some model number combinations may not be available. See website or contact your local Murata sales representative.**

## FUNCTIONAL SPECIFICATIONS – MODEL SPM25-033-D48

| ABSOLUTE MAXIMUM RATINGS  | Conditions ①  | Minimum | Typical/Nominal | Maximum | Units                   |
|---|---|---------|-----------------|---------|-------------------------|
| Input Voltage, Continuous   |   | 0       |                 | 80      | Vdc                     |
| Input Voltage, Transient  | 100 mS max. duration  |         |                 | 100     | Vdc                     |
| Isolation Voltage   | Input to output, continuous   |         |                 | 1600    | Vdc                     |
| On/Off Remote Control   | Power on, referred to -Vin  | 0       |                 | 15      | Vdc                     |
| Output Power  |   | 0       |                 | 25.25   | W                       |
| Output Current  | Current-limited, no damage, short-circuit protected                               | 0.7575  |                 | 7.575   | A                       |
| Storage Temperature Range   | Vin = Zero (no power)   | -55     |                 | 125     | °C                      |
| Absolute maximums are stress ratings. Exposure of devices to greater than any of these conditions may adversely affect long-term reliability. Proper operation under conditions other than those listed in the Performance/Functional Specifications Table is not implied or recommended. |   |         |                 |         |                         |
| <b>INPUT</b>  |   |         |                 |         |                         |
| Operating voltage range   |   | 36      | 48              | 75      | Vdc                     |
| Recommended External Fuse   | Fast blow   |         |                 | 1.5     | A                       |
| Start-up threshold  | Rising input voltage  | 34      | 35.2            | 36      | Vdc                     |
| Undervoltage shutdown   | Falling input voltage   | 32      | 34              | 35.2    | Vdc                     |
| Turn-On/Turn-Off Hysteresis   |   |         | 1.5             |         | Vdc                     |
| Internal Filter Type  |   |         | LC              |         |                         |
| <b>Input current</b>  |   |         |                 |         |                         |
| Full Load Input Current   | Vin = nominal   |         | 0.58            | 0.6     | A                       |
| Low Line Input Current  | Vin = minimum   |         | 0.79            | 0.81    | A                       |
| Inrush Transient  |   |         | 0.05            |         | A <sup>2</sup> -Sec.    |
| Short Circuit Input Current   |   |         | 50              | 100     | mA                      |
| No Load Input Current   | Iout = minimum, unit = ON   |         | 75              | 100     | mA                      |
| Shut-Down Input Current (Off, UV, OT)   |   |         | 1               | 2       | mA                      |
| Reflected (back) ripple current ②   | Measured at input with specified filter   |         | 30              |         | mA, p-p                 |
| <b>GENERAL and SAFETY</b>   |   |         |                 |         |                         |
| Efficiency  | Vin = 48V, full load  | 87      | 89.5            |         | %                       |
|   | Vin = min., full load   | 86.5    | 57.5            |         | %                       |
| <b>Isolation</b>  |   |         |                 |         |                         |
| Isolation Voltage   | Input to output, continuous   | 1600    |                 |         | Vdc                     |
| Insulation Safety Rating  |   |         | basic           |         |                         |
| Isolation Resistance  |   |         | 10              |         | MΩ                      |
| Isolation Capacitance   |   |         | 1000            |         | pF                      |
| Safety  | Certified to UL-60950-1, CSA-C22.2 No. 60950-1, IEC60950-1, 2nd edition, with AM1 |         | Yes             |         |                         |
| Calculated MTBF   | Per Telcordia SR332, issue 1, class 3, ground fixed, Tambient = +25°C             |         | TBD             |         | Hours x 10 <sup>6</sup> |
| <b>DYNAMIC CHARACTERISTICS</b>  |   |         |                 |         |                         |
| Fixed Switching Frequency   |   | 300     | 330             | 360     | KHz                     |
| Startup Time  | Power on to Vout regulated  |         |                 | 50      | mS                      |
| Startup Time  | Remote ON to Vout regulated   |         |                 | 50      | mS                      |
| Dynamic Load Response   | 50-75-50% load step, settling time to within 2% of Vout                           |         | 180             | 250     | μSec                    |
| Dynamic Load Peak Deviation   | same as above   |         | ±30             | ±100    | mV                      |
| <b>FEATURES and OPTIONS</b>   |   |         |                 |         |                         |
| <b>Remote On/Off Control ③</b>  |   |         |                 |         |                         |
| <b>"N" suffix</b>   |   |         |                 |         |                         |
| Negative Logic, ON state  | ON = Ground pin or external voltage   | -0.7    |                 | 0.8     | V                       |
| Negative Logic, OFF state   | OFF = Pin open or external voltage  | 10      |                 | 15      | V                       |
| Control Current   | Open collector/drain  |         | 1               |         | mA                      |
| <b>"P" suffix</b>   |   |         |                 |         |                         |
| Positive Logic, ON state  | ON = Pin open or external voltage   | 10      |                 | 15      | V                       |
| Positive Logic, OFF state   | OFF = Ground pin or external voltage  | -0.7    |                 | 0.7     | V                       |
| Control Current   | Open collector/drain  |         | 1               |         | mA                      |

## FUNCTIONAL SPECIFICATIONS (CONT.) – MODEL SPM25-033-D48

| OUTPUT   | Conditions ①   | Minimum | Typical/Nominal        | Maximum | Units         |
|--|--|---------|------------------------|---------|---------------|
| Total Output Power                                 | See Derating   | 0.0     | 25                     | 25.25   | W             |
| <b>Voltage</b>                                     |  |         |                        |         |               |
| Nominal Output Voltage                             | No trim  | 3.267   | 3.3                    | 3.333   | Vdc           |
| Setting Accuracy                                   | At 50% load, no trim                                 | -1      |                        | 1       | % of Vnom     |
| Output Voltage Range                               | User-adjustable                                      | -10     |                        | 10      | % of Vnom.    |
| Overvoltage Protection                             | Via magnetic feedback                                | 4.2     | 5                      | 5.7     | Vdc           |
| <b>Current</b>                                     |  |         |                        |         |               |
| Output Current Range                               |  | 0.7575  | 7.575                  | 7.575   | A             |
| Current Limit Inception                            | 98% of Vnom., after warmup                           | 8       | 10                     | 11.3    | A             |
| <b>Short Circuit</b>                               |  |         |                        |         |               |
| Short Circuit Current                              | Hiccup technique, autorecovery within ±1.25% of Vout |         |                        | 0.3     | A             |
| Short Circuit Duration (remove short for recovery) | Output shorted to ground, no damage                  |         | Continuous             |         |               |
| Short circuit protection method                    | Current limiting                                     |         |                        |         |               |
| <b>Regulation</b>                                  |  |         |                        |         |               |
| Line Regulation                                    | Vin = min. to max., Vout = nom., Iout = nom.         |         |                        | ±0.1    | % of Vout     |
| Load Regulation                                    | Iout = min. to max., Vin = 48V                       |         |                        | ±0.2    | % of Vout     |
| Ripple and Noise                                   | 5 Hz- 20 MHz BW                                      |         | 50                     | 80      | mV pk-pk      |
| Temperature Coefficient                            | At all outputs                                       |         | ±0.02                  |         | % of Vnom./°C |
| Maximum Capacitive Loading                         | Low ESR, resistive load only                         |         |                        | 2000    | µF            |
| <b>MECHANICAL</b>                                  |  |         |                        |         |               |
| Outline Dimensions                                 |  |         | 1" x 1" x 0.41"        |         | Inches        |
| (Please refer to outline drawing)                  | WxLxH  |         | 25.4 x 25.4 x 10.41 mm |         | mm            |
| Weight   |  |         | 0.69                   |         | Ounces        |
|  |  |         | 19.56                  |         | Grams         |
| Through Hole Pin Diameter                          |  |         | 0.04                   |         | Inches        |
|  |  |         | 1.016                  |         | mm            |
| Through Hole Pin Material                          |  |         | Copper alloy           |         |               |
| TH Pin Plating Metal and Thickness                 | Nickel subplate                                      |         | 50                     |         | µ-inches      |
|  | Gold overplate                                       |         | 5                      |         | µ-inches      |
| <b>ENVIRONMENTAL</b>                               |  |         |                        |         |               |
| Operating Ambient Temperature Range                | See derating   | -40     |                        | 85      | °C            |
| Operating Case Temperature Range                   | No derating  | -40     |                        | 105     | °C            |
| Case Material                                      | Tin plated steel with black powder coat              |         |                        |         |               |
| Storage Temperature                                | Vin = Zero (no power)                                | -55     |                        | 125     | °C            |
| Thermal Protection/Shutdown                        | Measured in center                                   | 110     | 115                    | 120     | °C            |
| Electromagnetic Interference                       | External filter is required                          |         |                        |         |               |
| Conducted, EN55022/CISPR22                         |  |         | B                      |         | Class         |
| Radiated, EN55022/CISPR22                          |  |         | B                      |         | Class         |
| RoHS rating  |  |         | RoHS-6                 |         |               |

### Notes

- ① Unless otherwise noted, all specifications are at nominal input voltage, nominal output voltage and full load. General conditions are +25° Celsius ambient temperature, near sea level altitude, natural convection airflow. All models are tested and specified with external parallel 1 µF and 10 µF output capacitors. The external input capacitor is 22 µF. All capacitors are low-ESR types wired close to the converter.
- ② Input (back) ripple current is tested and specified over 5 Hz to 20 MHz bandwidth. Input filtering is Cbus=220 µF, Cin=33 µF and Lbus=12 µH.
- ③ The Remote On/Off Control is referred to -Vin.

## TYPICAL PERFORMANCE DATA, SPM25-033-D48

Efficiency vs. Line Voltage and Load Current @ 25°C

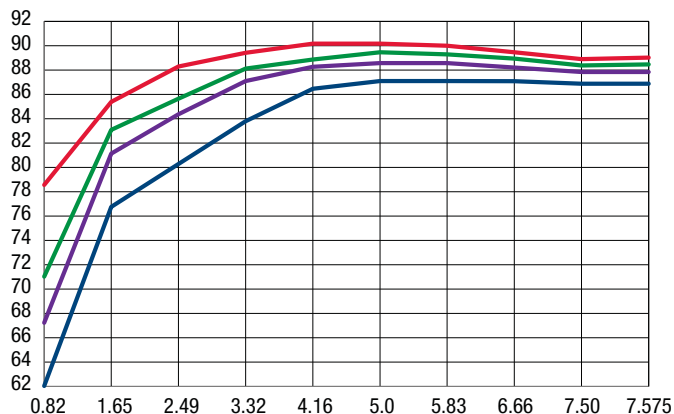

Power Dissipation

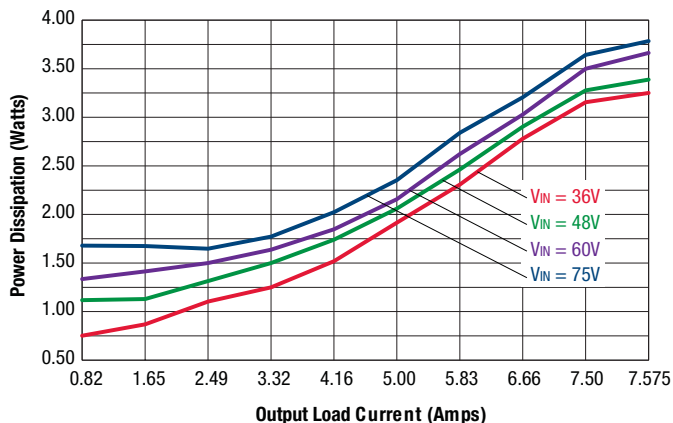

Maximum Current Temperature Derating at sea level  
V<sub>in</sub> = 36 (air flow from J1 to J3 on PCB)

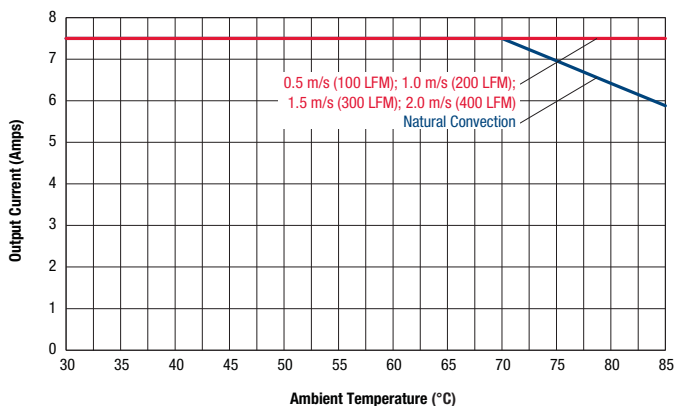

Maximum Current Temperature Derating at sea level  
V<sub>in</sub> = 48 (air flow from J1 to J3 on PCB)

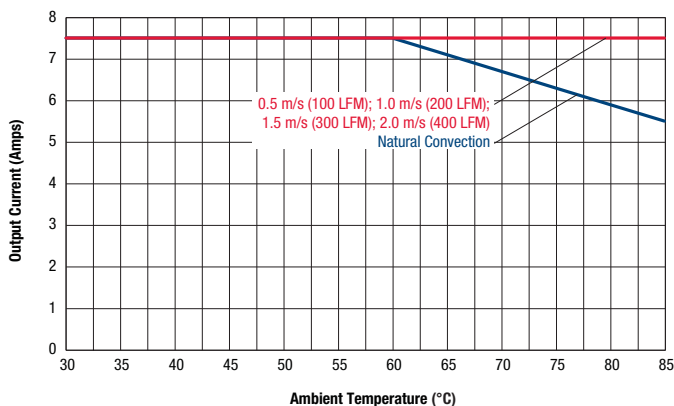

Maximum Current Temperature Derating at sea level  
V<sub>in</sub> = 60 (air flow from J1 to J3 on PCB)

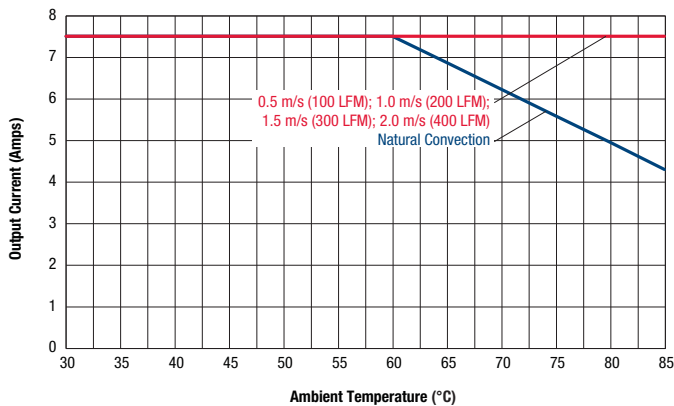

Maximum Current Temperature Derating at sea level  
V<sub>in</sub> = 75 (air flow from J1 to J3 on PCB)

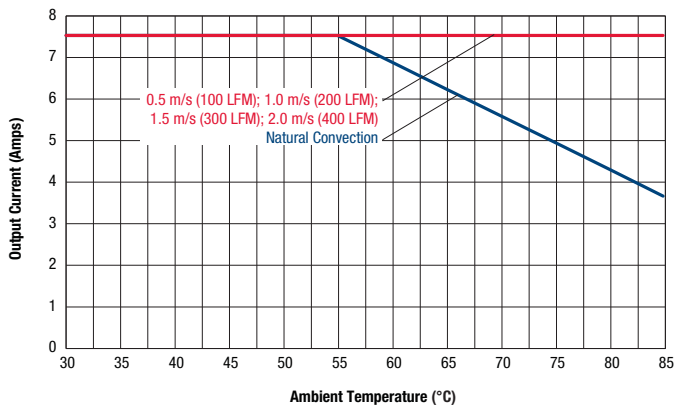

## TYPICAL PERFORMANCE DATA, SPM25-033-D48

Start-up Delay(Vin=48V, Iout=7.5A, Ta=+25°C) Ch1=Vin, Ch4=Vout

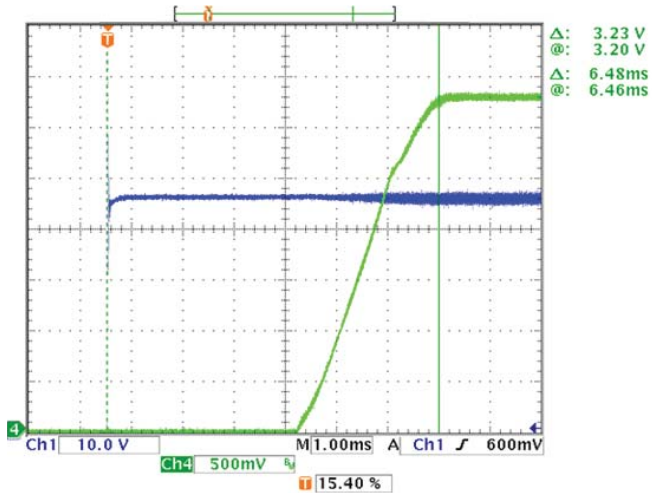

Enable Start-up Delay(Vin=48V, Iout=7.5A, Ta=+25°C) Ch1=Enable, Ch4=Vout

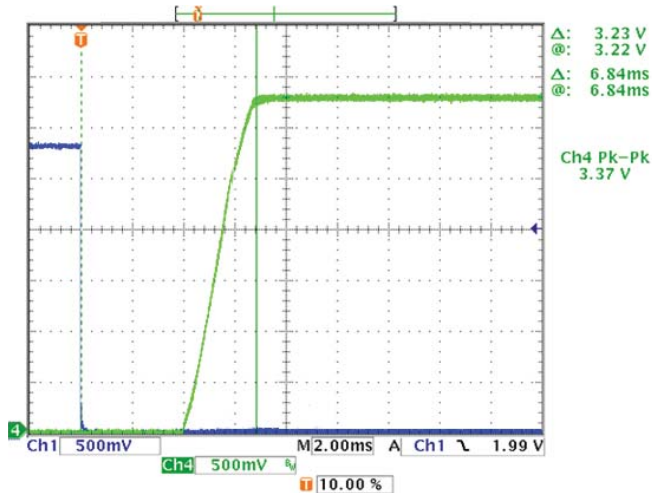

Output Ripple and Noise (Vin = 48V, Io = 0A, Cload = 1μF || 10μF, Ta = +25°C)

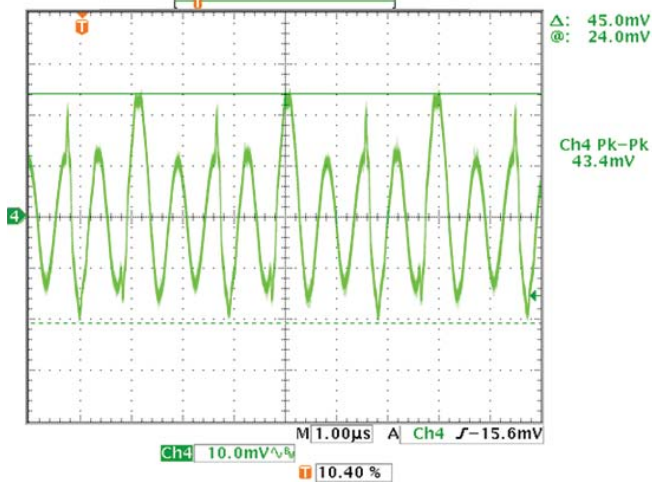

Output Ripple and Noise (Vin = 48V, Io = 7.5A, Cload = 1μF || 10μF, Ta = +25°C)

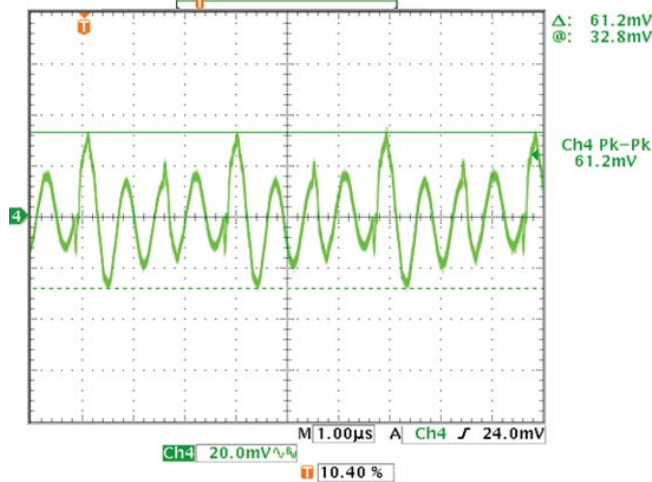

Step Load Transient Response(Vin=48V, Vout=nom, Iout=50 to 100% of full load, Cout=1μF || 10μF)

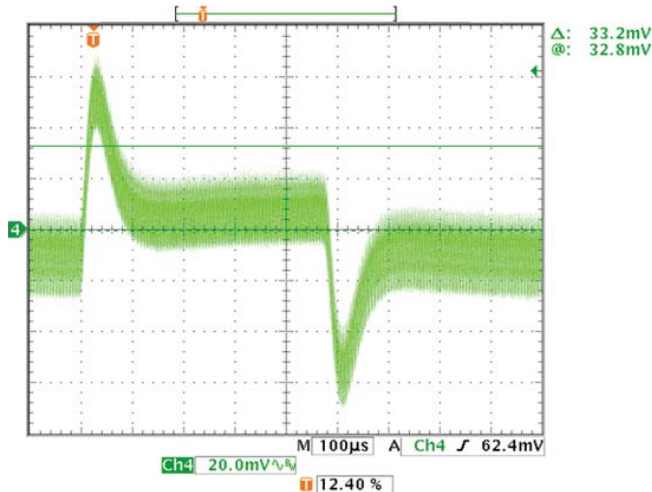

## FUNCTIONAL SPECIFICATIONS – MODEL SPM25-050-D48

| ABSOLUTE MAXIMUM RATINGS  | Conditions ①  | Minimum | Typical/Nominal | Maximum | Units                   |
|---|---|---------|-----------------|---------|-------------------------|
| Input Voltage, Continuous   |   | 0       |                 | 80      | Vdc                     |
| Input Voltage, Transient  | 100 mS max. duration  |         |                 | 100     | Vdc                     |
| Isolation Voltage   | Input to output, continuous   |         |                 | 1600    | Vdc                     |
| On/Off Remote Control   | Power on, referred to -Vin  | 0       |                 | 15      | Vdc                     |
| Output Power  |   | 0       |                 | 25.25   | W                       |
| Output Current  | Current-limited, no damage, short-circuit protected                               | 0       |                 | 5       | A                       |
| Storage Temperature Range   | Vin = Zero (no power)   | -55     |                 | 125     | °C                      |
| Absolute maximums are stress ratings. Exposure of devices to greater than any of these conditions may adversely affect long-term reliability. Proper operation under conditions other than those listed in the Performance/Functional Specifications Table is not implied or recommended. |   |         |                 |         |                         |
| <b>INPUT</b>  |   |         |                 |         |                         |
| Operating voltage range   |   | 36      | 48              | 75      | Vdc                     |
| Recommended External Fuse   | Fast blow   |         |                 | 1.5     | A                       |
| Start-up threshold  | Rising input voltage  | 33      | 34              | 35      | Vdc                     |
| Undervoltage shutdown   | Falling input voltage   | 31.5    | 32.5            | 34.5    | Vdc                     |
| Turn-On/Turn-Off Hysteresis   |   |         | 1.5             |         | Vdc                     |
| Internal Filter Type  |   |         | LC              |         |                         |
| <b>Input current</b>  |   |         |                 |         |                         |
| Full Load Input Current   | Vin = nominal   |         | 0.57            | 0.6     | A                       |
| Low Line Input Current  | Vin = minimum   |         | 0.76            | 0.79    | A                       |
| Inrush Transient  |   |         | 0.05            |         | A <sup>2</sup> -Sec.    |
| Short Circuit Input Current   |   |         | 50              | 100     | mA                      |
| No Load Input Current   | Iout = minimum, unit=ON   |         | 30              | 50      | mA                      |
| Shut-Down Input Current (Off, UV, OT)   |   |         | 1               | 3       | mA                      |
| Reflected (back) ripple current ②   | Measured at input with specified filter   |         | 30              |         | mA, p-p                 |
| Pre-biased startup  | External output voltage < Vset  |         | Monotonic       |         |                         |
| <b>GENERAL and SAFETY</b>   |   |         |                 |         |                         |
| Efficiency  | Vin = 48V, full load  | 88.3    | 91              |         | %                       |
|   | Vin = min., full load   | 88.5    | 91              |         | %                       |
| <b>Isolation</b>  |   |         |                 |         |                         |
| Isolation Voltage   | Input to output, continuous   | 1600    |                 |         | Vdc                     |
| Insulation Safety Rating  |   |         | basic           |         |                         |
| Isolation Resistance  |   |         | 10              |         | MΩ                      |
| Isolation Capacitance   |   |         | 2000            |         | pF                      |
| Safety  | Certified to UL-60950-1, CSA-C22.2 No. 60950-1, IEC60950-1, 2nd edition, with AM1 |         | Yes             |         |                         |
| Calculated MTBF   | Per Telcordia SR332, issue 1, class 3, ground fixed, Tambient = +25°C             |         | 4.5             |         | Hours x 10 <sup>6</sup> |
| <b>DYNAMIC CHARACTERISTICS</b>  |   |         |                 |         |                         |
| Fixed Switching Frequency   |   | 300     | 330             | 360     | KHz                     |
| Startup Time  | Power on to Vout regulated  |         |                 | 50      | mS                      |
| Startup Time  | Remote ON to Vout regulated   |         |                 | 50      | mS                      |
| Dynamic Load Response   | 50-75-50% load step, settling time to within 1% of Vout                           |         | 50              | 100     | μSec                    |
| Dynamic Load Peak Deviation   | same as above   |         | ±75             | ±125    | mV                      |
| <b>FEATURES and OPTIONS</b>   |   |         |                 |         |                         |
| <b>Remote On/Off Control ③</b>  |   |         |                 |         |                         |
| "N" suffix  |   |         |                 |         |                         |
| Negative Logic, ON state  | ON = Ground pin or external voltage   | -0.7    |                 | 0.8     | V                       |
| Negative Logic, OFF state   | OFF = Pin open or external voltage  | 10      |                 | 15      | V                       |
| Control Current   | Open collector/drain  |         | 1               |         | mA                      |
| "P" suffix  |   |         |                 |         |                         |
| Positive Logic, ON state  | ON = Pin open or external voltage   | 10      |                 | 15      | V                       |
| Positive Logic, OFF state   | OFF = Ground pin or external voltage  | -0.7    |                 | 0.7     | V                       |
| Control Current   | Open collector/drain  |         | 1               |         | mA                      |

## FUNCTIONAL SPECIFICATIONS (CONT.) – MODEL SPM25-050-D48

| OUTPUT   | Conditions ①   | Minimum | Typical/Nominal        | Maximum | Units         |
|--|--|---------|------------------------|---------|---------------|
| Total Output Power                                 | See Derating   | 0.0     | 25                     | 25.25   | W             |
| <b>Voltage</b>                                     |  |         |                        |         |               |
| Nominal Output Voltage                             | No trim  | 4.95    | 5                      | 5.05    | Vdc           |
| Setting Accuracy                                   | At 50% load, no trim                                 | -1      |                        | 1       | % of Vset     |
| Output Voltage Range                               | User-adjustable                                      | -10     |                        | 10      | % of Vnom     |
| Oversvoltage Protection                            | Via magnetic feedback                                | 6       | 6.5                    | 7.5     | Vdc           |
| <b>Current</b>                                     |  |         |                        |         |               |
| Output Current Range                               |  | 0       | 5                      | 5       | A             |
| Minimum Load                                       |  |         | No minimum load        |         | % of Iout     |
| Current Limit Inception                            | 98% of Vnom., after warmup                           | 5.3     | 7.05                   | 8.3     | A             |
| <b>Short Circuit</b>                               |  |         |                        |         |               |
| Short Circuit Current                              | Hiccup technique, autorecovery within ±1.25% of Vout |         |                        | 0.3     | A             |
| Short Circuit Duration (remove short for recovery) | Output shorted to ground, no damage                  |         | Continuous             |         |               |
| Short circuit protection method                    | Current limiting                                     |         |                        |         |               |
| <b>Regulation</b>                                  |  |         |                        |         |               |
| Line Regulation                                    | Vin = min. to max., Vout = nom., Iout = nom.         |         |                        | ±0.1    | % of Vout     |
| Load Regulation                                    | Iout = min. to max., Vin = 48V                       |         |                        | ±0.2    | % of Vout     |
| Ripple and Noise                                   | 5 Hz - 20 MHz BW                                     |         | 50                     | 80      | mV pk-pk      |
| Temperature Coefficient                            | At all outputs                                       |         | ±0.02                  |         | % of Vnom./°C |
| Maximum Capacitive Loading                         | Low ESR, resistive load only                         |         |                        | 2000    | µF            |
| <b>MECHANICAL</b>                                  |  |         |                        |         |               |
| Outline Dimensions                                 |  |         | 1" x 1" x 0.41"        |         | Inches        |
| (Please refer to outline drawing)                  | WxLxH  |         | 25.4 x 25.4 x 10.41 mm |         | mm            |
| Weight   |  |         | 0.69                   |         | Ounces        |
|  |  |         | 19.56                  |         | Grams         |
| Through Hole Pin Diameter                          |  |         | 0.04                   |         | Inches        |
|  |  |         | 1.016                  |         | mm            |
| Through Hole Pin Material                          |  |         | Copper alloy           |         |               |
| TH Pin Plating Metal and Thickness                 | Nickel subplate                                      |         | 50                     |         | µ-inches      |
|  | Gold overplate                                       |         | 5                      |         | µ-inches      |
| <b>ENVIRONMENTAL</b>                               |  |         |                        |         |               |
| Operating Ambient Temperature Range                | See derating   | -40     |                        | 85      | °C            |
| Operating Case Temperature Range                   | No derating  | -40     |                        | 105     | °C            |
| Case Material                                      | Tin plated steel with black powder coat              |         |                        |         |               |
| Storage Temperature                                | Vin = Zero (no power)                                | -55     |                        | 125     | °C            |
| Thermal Protection/Shutdown                        | Measured in center                                   | 110     | 115                    | 120     | °C            |
| Electromagnetic Interference                       | External filter is required                          |         |                        |         |               |
| Conducted, EN55022/CISPR22                         |  |         | B                      |         | Class         |
| Radiated, EN55022/CISPR22                          |  |         | B                      |         | Class         |
| RoHS rating  |  |         | RoHS-6                 |         |               |
| ESD (Electrostatic Discharge)                      | Designed to meet EN61000-4-2 Perf. Criteria A        |         |                        |         |               |

### Notes

- ① Unless otherwise noted, all specifications are at nominal input voltage, nominal output voltage and full load. General conditions are +25° Celsius ambient temperature, near sea level altitude, natural convection airflow. All models are tested and specified with external parallel 1 µF and 10 µF output capacitors. The external input capacitor is 22 µF. All capacitors are low-ESR types wired close to the converter.
- ② Input (back) ripple current is tested and specified over 5 Hz to 20 MHz bandwidth. Input filtering is Cbus=220 µF, Cin=33 µF and Lbus=12 µH.
- ③ The Remote On/Off Control is referred to -Vin.



## TYPICAL PERFORMANCE DATA, SPM25-050-D48

Efficiency vs. Line Voltage and Load Current @ 25°C

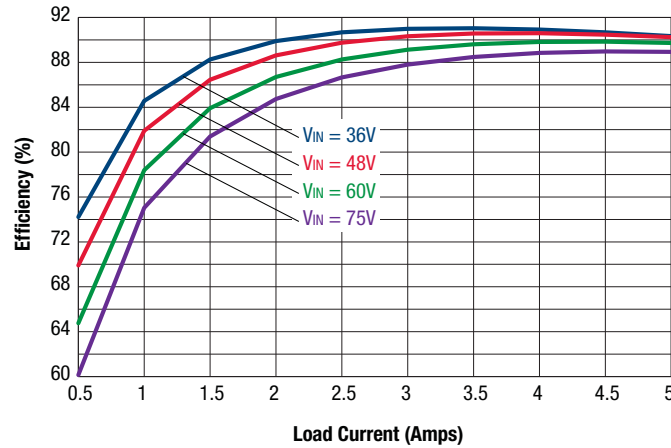

Maximum Current Temperature Derating at sea level  
VIN = 36 (air flow from J1 to J2 on PCB)

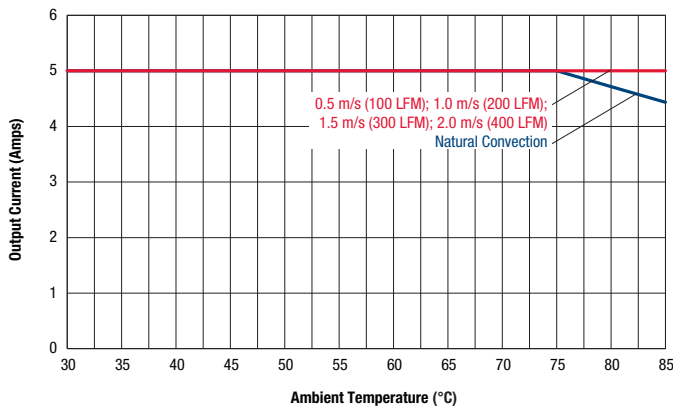

Maximum Current Temperature Derating at sea level  
VIN = 48 (air flow from J1 to J2 on PCB)

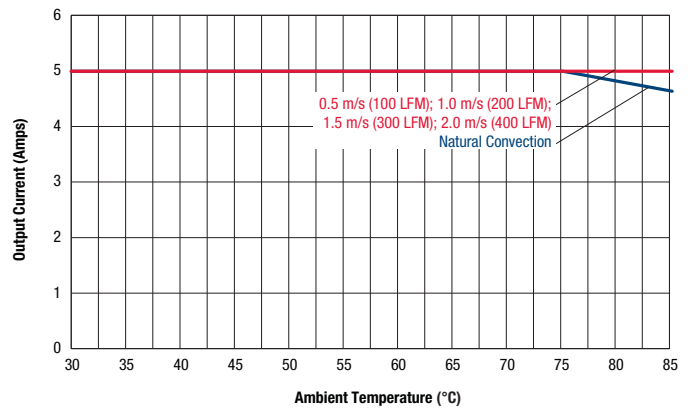

Maximum Current Temperature Derating at sea level  
VIN = 60 (air flow from J1 to J2 on PCB)

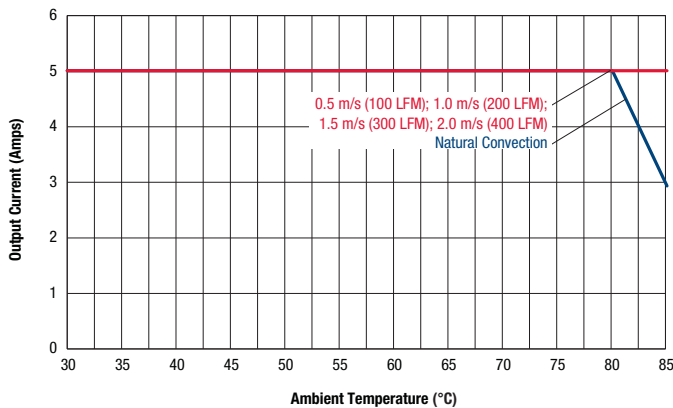

Maximum Current Temperature Derating at sea level  
VIN = 75 (air flow from J1 to J2 on PCB)

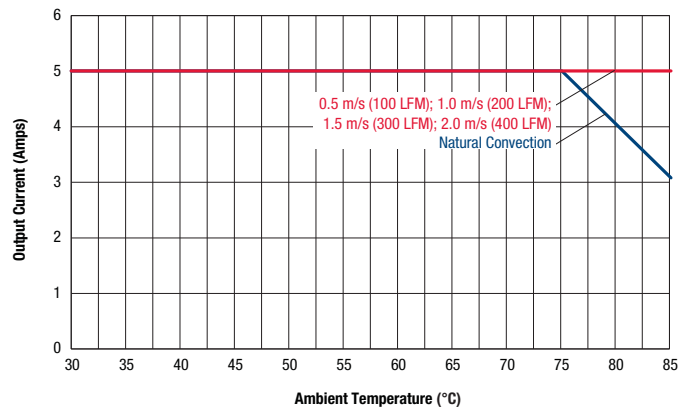

## TYPICAL PERFORMANCE DATA, SPM25-050-D48

Start-up Delay (Vin = 48V, Iout = 5A, Ta = +25°C) Ch1 = Vin, Ch4 = Vout

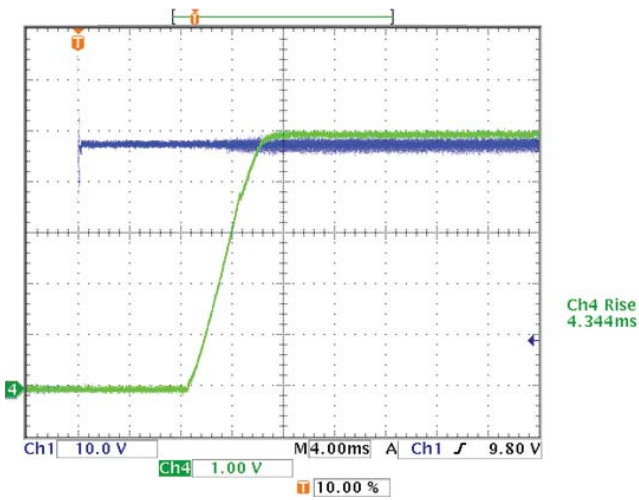

Enable Start-up Delay (Vin = 48V, Iout = 5A, Ta = +25°C) Ch1 = Enable, Ch4 = Vout

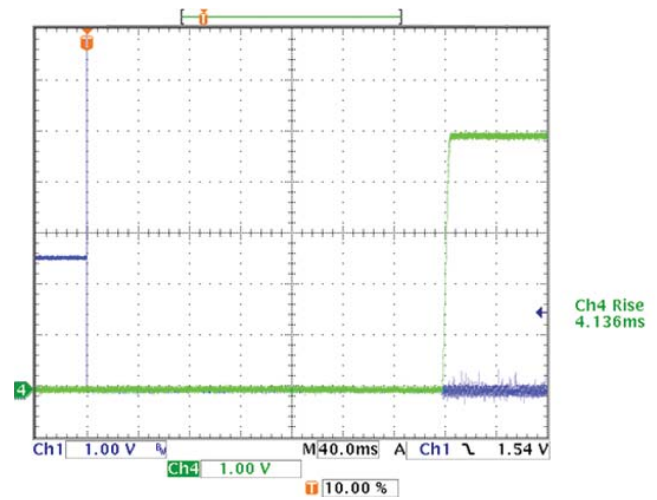

Output Ripple and Noise (Vin = 48V, Io = 5A, Load = 1μF || 10μF, Ta = +25°C)

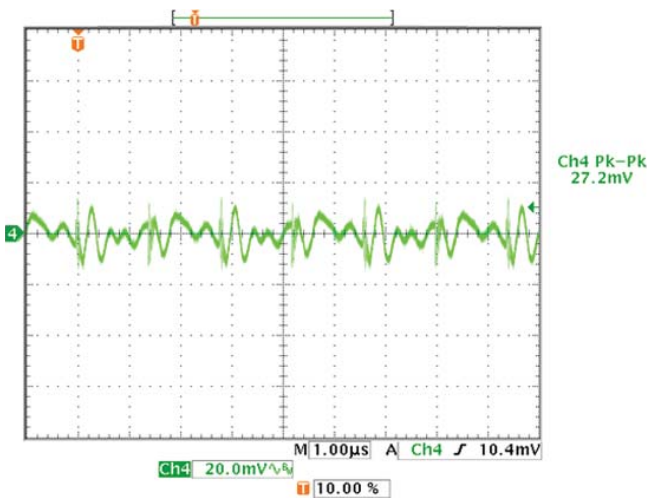

Step Load Transient Response (Vin = 48V, Vout = nom, Iout = 100 to 50% of full load 1μF || 10μF)

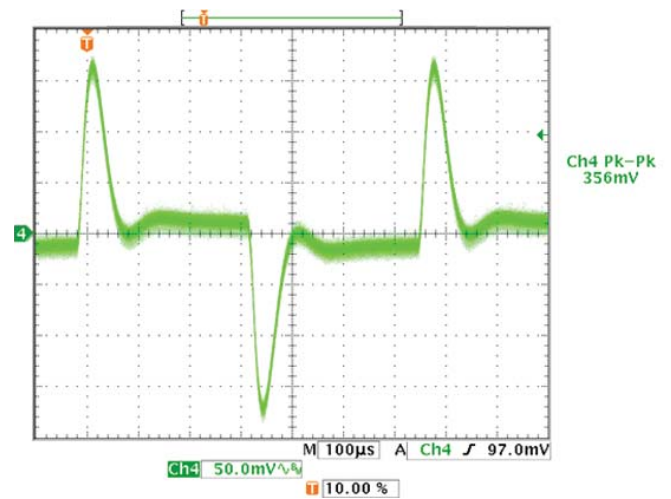

## FUNCTIONAL SPECIFICATIONS – MODEL SPM25-120-D48

| ABSOLUTE MAXIMUM RATINGS  | Conditions ①  | Minimum | Typical/Nominal | Maximum | Units                   |
|---|---|---------|-----------------|---------|-------------------------|
| Input Voltage, Continuous   |   | 0       |                 | 80      | Vdc                     |
| Input Voltage, Transient  | 100 mS max. duration  |         |                 | 100     | Vdc                     |
| Isolation Voltage   | Input to output, continuous   |         |                 | 1600    | Vdc                     |
| On/Off Remote Control   | Power on, referred to -Vin  | 0       |                 | 15      | Vdc                     |
| Output Power  |   | 0       |                 | 25.45   | W                       |
| Output Current  | Current-limited, no damage, short-circuit protected                               | 0       |                 | 5       | A                       |
| Storage Temperature Range   | Vin = Zero (no power)   | -55     |                 | 125     | °C                      |
| Absolute maximums are stress ratings. Exposure of devices to greater than any of these conditions may adversely affect long-term reliability. Proper operation under conditions other than those listed in the Performance/Functional Specifications Table is not implied or recommended. |   |         |                 |         |                         |
| <b>INPUT</b>  |   |         |                 |         |                         |
| Operating voltage range   |   | 36      | 48              | 75      | Vdc                     |
| Recommended External Fuse   | Fast blow   |         |                 | 1.5     | A                       |
| Start-up threshold  | Rising input voltage  | 32.8    | 34              | 35      | Vdc                     |
| Undervoltage shutdown   | Falling input voltage   | 32      | 33.5            | 35      | Vdc                     |
| Turn-On/Turn-Off Hysteresis   |   |         | 1.5             |         | Vdc                     |
| Internal Filter Type  |   |         | C               |         |                         |
| Input current   |   |         |                 |         |                         |
| Full Load Input Current   | Vin = nominal   |         | 0.603           | 0.624   | A                       |
| Low Line Input Current  | Vin = minimum   |         | 0.809           | 0.842   | A                       |
| Inrush Transient  |   |         | 0.05            |         | A <sup>2</sup> -Sec.    |
| Short Circuit Input Current   |   |         | 50              | 100     | mA                      |
| No Load Input Current   | Iout = minimum, unit=ON   |         | 20              | 35      | mA                      |
| Shut-Down Input Current (Off, UV, OT)   |   |         | 1               | 2       | mA                      |
| Reflected (back) ripple current ②   | Measured at input with specified filter   |         | 30              |         | mA, p-p                 |
| Pre-biased startup  | External output voltage < Vset  |         | Monotonic       |         |                         |
| <b>GENERAL and SAFETY</b>   |   |         |                 |         |                         |
| Efficiency  | Vin = 48V, full load  | 85      | 87              |         | %                       |
|   | Vin = min., full load   |         | 86.5            |         | %                       |
| Isolation   |   |         |                 |         |                         |
| Isolation Voltage   | Input to output, continuous   | 1600    |                 |         | Vdc                     |
| Insulation Safety Rating  |   |         | basic           |         |                         |
| Isolation Resistance  |   |         | 10              |         | MΩ                      |
| Isolation Capacitance   |   |         | 1700            |         | pF                      |
| Safety  | Certified to UL-60950-1, CSA-C22.2 No. 60950-1, IEC60950-1, 2nd edition, with AM1 |         | Yes             |         |                         |
| Calculated MTBF   | Per Telcordia SR332, issue 1, class 3, ground fixed, Tambient = +25°C             |         | 5.9             |         | Hours x 10 <sup>6</sup> |
| <b>DYNAMIC CHARACTERISTICS</b>  |   |         |                 |         |                         |
| Fixed Switching Frequency   |   | 295     | 325             | 355     | KHz                     |
| Startup Time  | Power on to Vout regulated  |         | 10              | 50      | mS                      |
| Startup Time  | Remote ON to Vout regulated   |         | 10              | 50      | mS                      |
| Dynamic Load Response   | 50-75-50% load step, settling time to within 1% of Vout                           |         | 100             | 150     | μSec                    |
| Dynamic Load Peak Deviation   | same as above   |         | ±250            | ±350    | mV                      |
| <b>FEATURES and OPTIONS</b>   |   |         |                 |         |                         |
| Remote On/Off Control ③   |   |         |                 |         |                         |
| "N" suffix  |   |         |                 |         |                         |
| Negative Logic, ON state  | ON = Ground pin or external voltage   | -0.7    |                 | 0.8     | V                       |
| Negative Logic, OFF state   | OFF = Pin open or external voltage  | 10      |                 | 15      | V                       |
| Control Current   | Open collector/drain  |         | 1               |         | mA                      |
| "P" suffix  |   |         |                 |         |                         |
| Positive Logic, ON state  | ON = Pin open or external voltage   | 10      |                 | 15      | V                       |
| Positive Logic, OFF state   | OFF = Ground pin or external voltage  | -0.7    |                 | 0.7     | V                       |
| Control Current   | Open collector/drain  |         | 1               |         | mA                      |

## FUNCTIONAL SPECIFICATIONS (CONT.) – MODEL SPM25-120-D48

| OUTPUT   | Conditions ① ③                                       | Minimum | Typical/Nominal        | Maximum | Units         |
|--|--|---------|------------------------|---------|---------------|
| Total Output Power                                 | See Derating   | 0.0     | 25.2                   | 25.45   | W             |
| <b>Voltage</b>                                     |  |         |                        |         |               |
| Nominal Output Voltage                             | No trim  | 11.88   | 12                     | 12.12   | Vdc           |
| Setting Accuracy                                   | At 50% load, no trim                                 | -1      |                        | 1       | % of Vset     |
| Output Voltage Range                               | User-adjustable                                      | -10     |                        | 10      | % of Vnom     |
| Overvoltage Protection                             | Via magnetic feedback                                | 14      | 19                     | 22      | Vdc           |
| <b>Current</b>                                     |  |         |                        |         |               |
| Output Current Range                               |  | 0       | 2.1                    | 2.1     | A             |
| Minimum Load                                       |  |         | No minimum load        |         | % of Iout     |
| Current Limit Inception                            | 98% of Vnom., after warmup                           | 2.3     | 3                      | 3.4     | A             |
| <b>Short Circuit</b>                               |  |         |                        |         |               |
| Short Circuit Current                              | Hiccup technique, autorecovery within ±1.25% of Vout |         |                        | 0.1     | A             |
| Short Circuit Duration (remove short for recovery) | Output shorted to ground, no damage                  |         | Continuous             |         |               |
| Short circuit protection method                    | Current limiting                                     |         |                        |         |               |
| <b>Regulation</b>                                  |  |         |                        |         |               |
| Line Regulation                                    | Vin = min. to max., Vout = nom., Iout = nom.         |         |                        | ±0.1    | % of Vout     |
| Load Regulation                                    | Iout = min. to max., Vin = 48V                       |         |                        | ±0.125  | % of Vout     |
| Ripple and Noise                                   | 5 Hz - 20 MHz BW                                     |         | 65                     | 120     | mV pk-pk      |
| Temperature Coefficient                            | At all outputs                                       |         | ±0.02                  |         | % of Vnom./°C |
| Maximum Capacitive Loading                         | Low ESR, resistive load only                         |         |                        | 470     | µF            |
| <b>MECHANICAL</b>                                  |  |         |                        |         |               |
| Outline Dimensions                                 |  |         | 1" x 1" x 0.41"        |         | Inches        |
| (Please refer to outline drawing)                  | WxLxH  |         | 25.4 x 25.4 x 10.41 mm |         | mm            |
| Weight   |  |         | 0.69                   |         | Ounces        |
|  |  |         | 19.56                  |         | Grams         |
| Through Hole Pin Diameter                          |  |         | 0.04                   |         | Inches        |
|  |  |         | 1.016                  |         | mm            |
| Through Hole Pin Material                          |  |         | Copper alloy           |         |               |
| TH Pin Plating Metal and Thickness                 | Nickel subplate                                      |         | 50                     |         | µ-inches      |
|  | Gold overplate                                       |         | 5                      |         | µ-inches      |
| <b>ENVIRONMENTAL</b>                               |  |         |                        |         |               |
| Operating Ambient Temperature Range                | See derating   | -40     |                        | 85      | °C            |
| Operating Case Temperature Range                   | No derating  | -40     |                        | 105     | °C            |
| Case Material                                      | Tin plated steel with black powder coat              |         |                        |         |               |
| Storage Temperature                                | Vin = Zero (no power)                                | -55     |                        | 125     | °C            |
| Thermal Protection/Shutdown                        | Measured in center                                   | 110     | 115                    | 120     | °C            |
| Electromagnetic Interference                       | External filter is required                          |         |                        |         |               |
| Conducted, EN55022/CISPR22                         |  |         | B                      |         | Class         |
| Radiated, EN55022/CISPR22                          |  |         | B                      |         | Class         |
| RoHS rating  |  |         | RoHS-6                 |         |               |

### Notes

- ① Unless otherwise noted, all specifications are at nominal input voltage, nominal output voltage and full load. General conditions are +25° Celsius ambient temperature, near sea level altitude, natural convection airflow. All models are tested and specified with external parallel 1 µF and 10 µF output capacitors. The external input capacitor is 4.7 µF. All capacitors are low-ESR types wired close to the converter.
- ② Input (back) ripple current is tested and specified over 5 Hz to 20 MHz bandwidth. Input filtering is Cbus=220 µF, Cin=33 µF and Lbus=12 µH.
- ③ The Remote On/Off Control is referred to -Vin.

## TYPICAL PERFORMANCE DATA, SPM25-120-D48

Efficiency vs. Line Voltage and Load Current @ 25°C

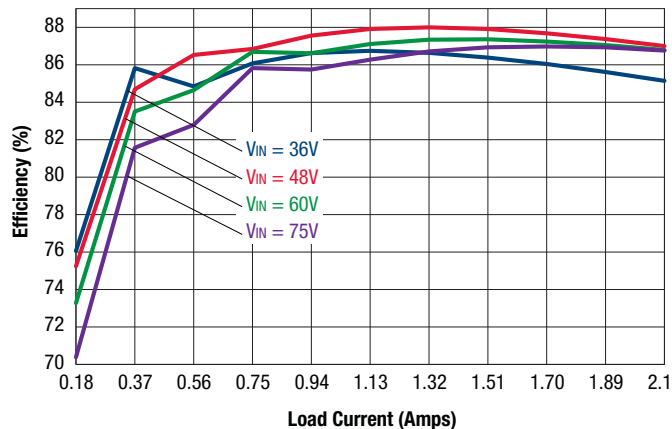

Power Dissipation

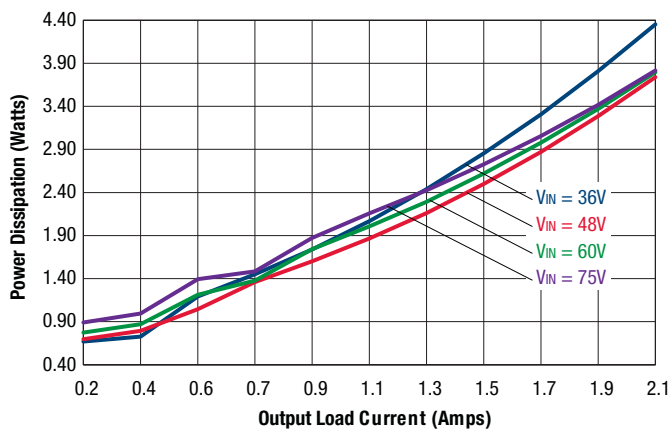

Maximum Current Temperature Derating at sea level  
Vin = 36 (air flow from J1 to J2 on PCB)

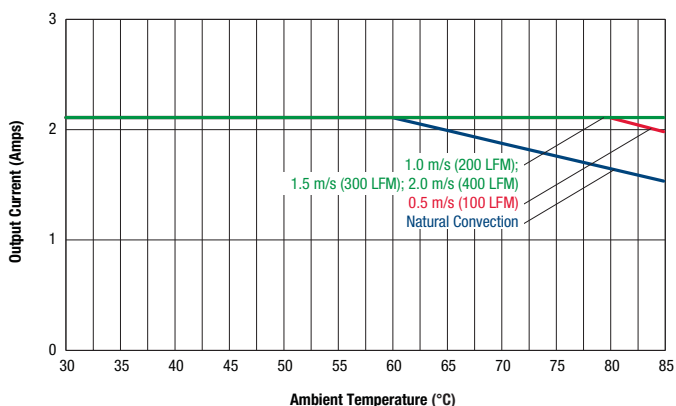

Maximum Current Temperature Derating at sea level  
Vin = 48 (air flow from J1 to J2 on PCB)

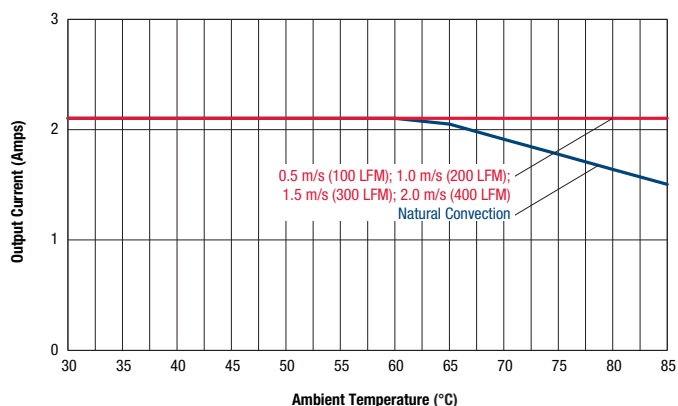

Maximum Current Temperature Derating at sea level  
Vin = 60 (air flow from J1 to J2 on PCB)

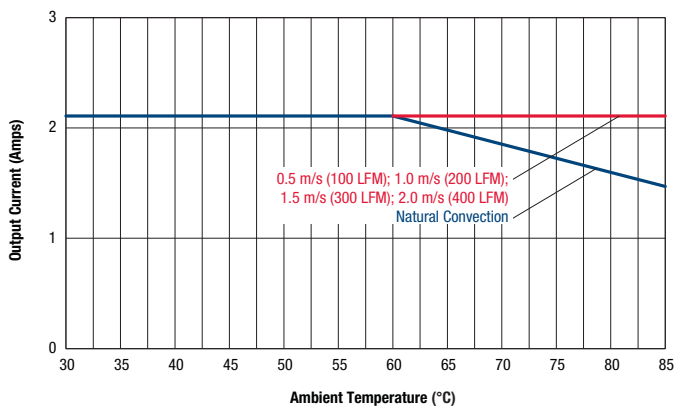

Maximum Current Temperature Derating at sea level  
Vin = 75 (air flow from J1 to J2 on PCB)

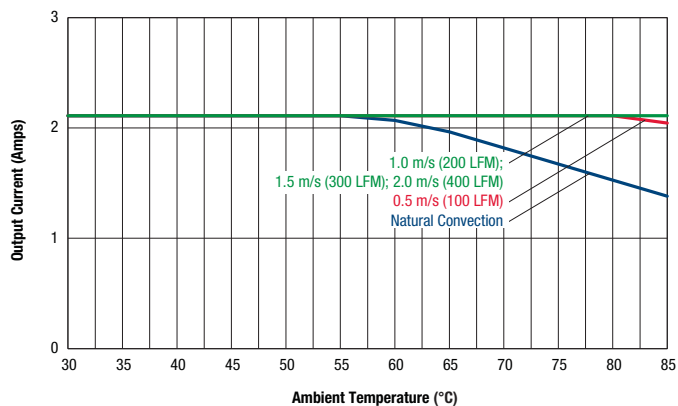

## TYPICAL PERFORMANCE DATA, SPM25-120-D48

Start-up Delay (Vin = 48V, Iout = 2.1A, Ta = +25°C) Ch1 = Vin, Ch4 = Vout

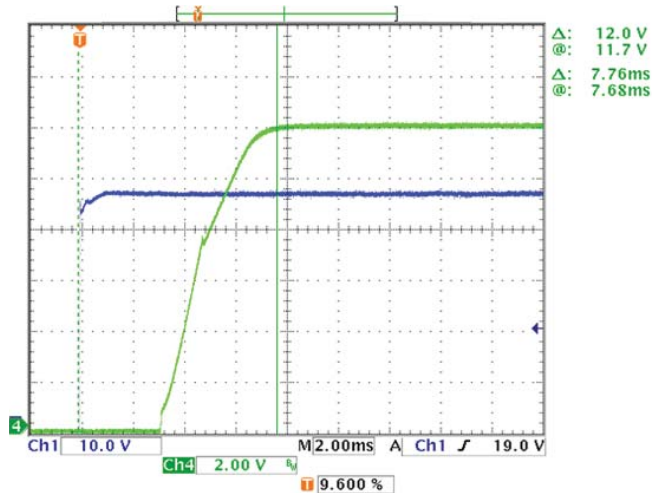

Enable Start-up Delay (Vin = 48V, Iout = 2.1A, Ta = +25°C) Ch1 = Enable, Ch4 = Vout

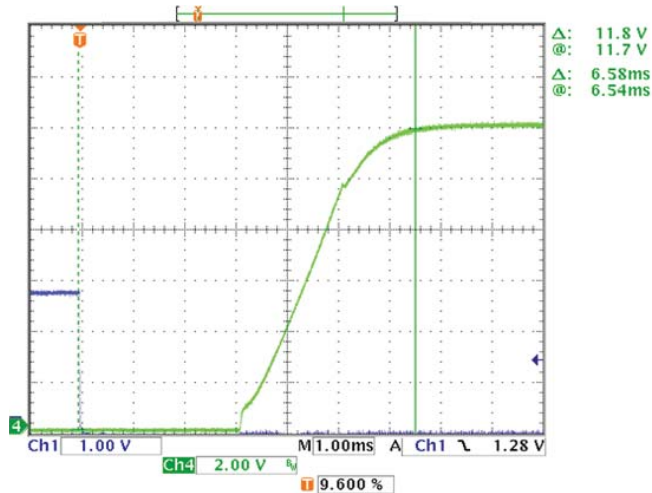

Output Ripple and Noise (Vin = 48V, I<sub>o</sub> = 2.1A, Cload = 1μF || 10μF, Ta = +25°C)

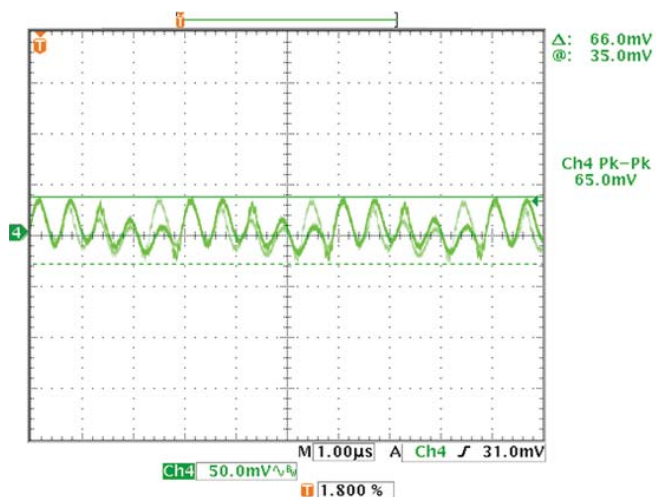

Step Load Transient Response (Vin = 48V, Vout = nom, Iout = 100 to 50% of full load 1μF || 10μF)

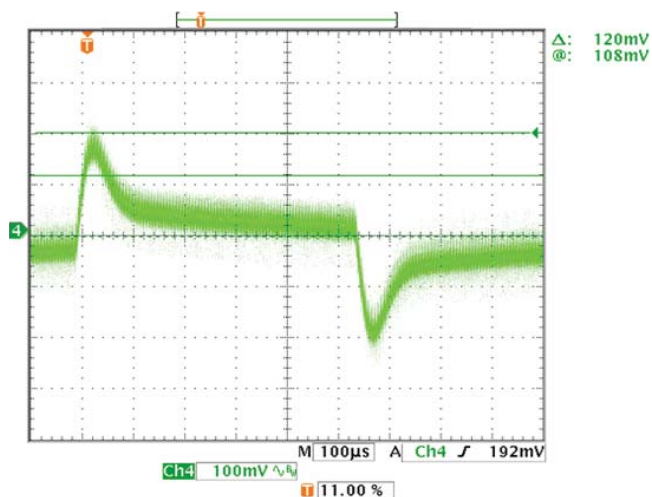

**MECHANICAL SPECIFICATIONS**

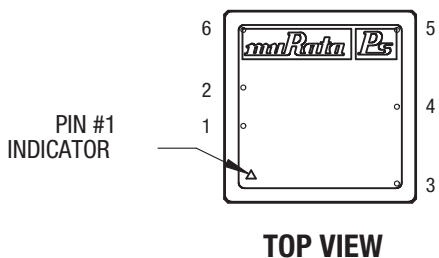
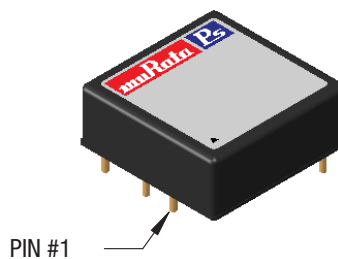
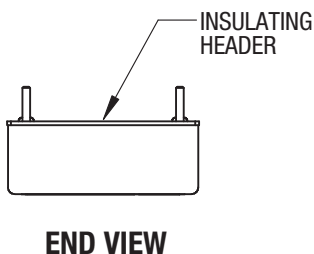
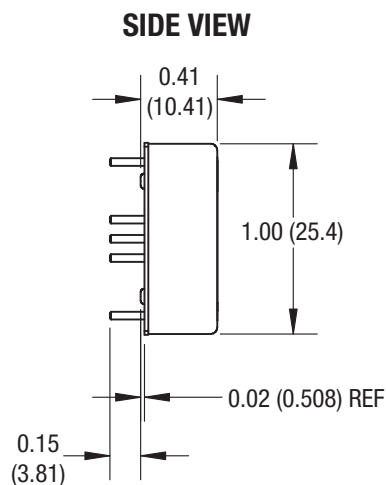
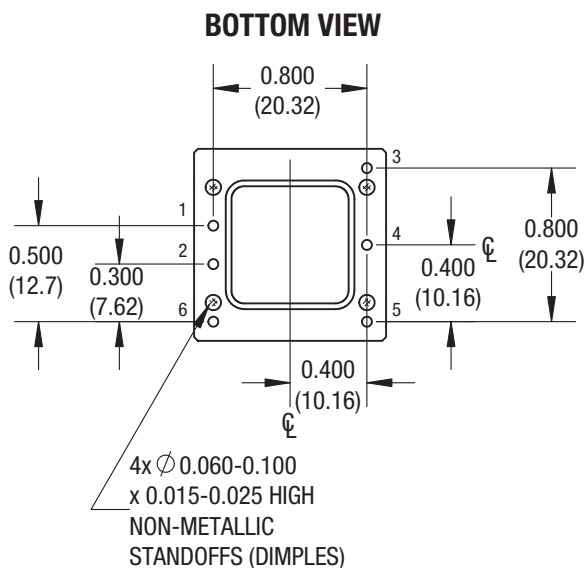

**ISOMETRIC VIEW**  
(FOR REF ONLY)

| INPUT/OUTPUT CONNECTIONS |                              |
|--------------------------|------------------------------|
| Pin                      | SPM Function (Single Output) |
| 1                        | +Vin                         |
| 2                        | -Vin                         |
| 3                        | +Vout                        |
| 4                        | Output Trim*                 |
| 5                        | -Vout                        |
| 6                        | On/Off Control*              |

\* The Output Trim and On/Off Control pins are optional. Also, the Remote On/Off can be provided with either positive (P suffix) or negative (N suffix) logic. Please see the Part Number Structure on Page 2.

Dimensions are in inches (mm shown for ref. only).

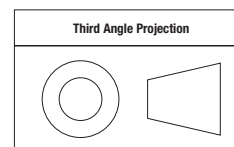

Tolerances (unless otherwise specified):  
 .XX ± 0.02 (0.5)  
 .XXX ± 0.010 (0.25)  
 Angles ± 1°  
 Components are shown for reference only.

MATERIAL:  
 Ø.040 PINS: COPPER ALLOY

FINISH: (ALL PINS)  
 GOLD (5µ"MIN) OVER NICKEL (50µ" MIN)

RECOMMENDED FOOTPRINT (VIEW THROUGH CONVERTER)

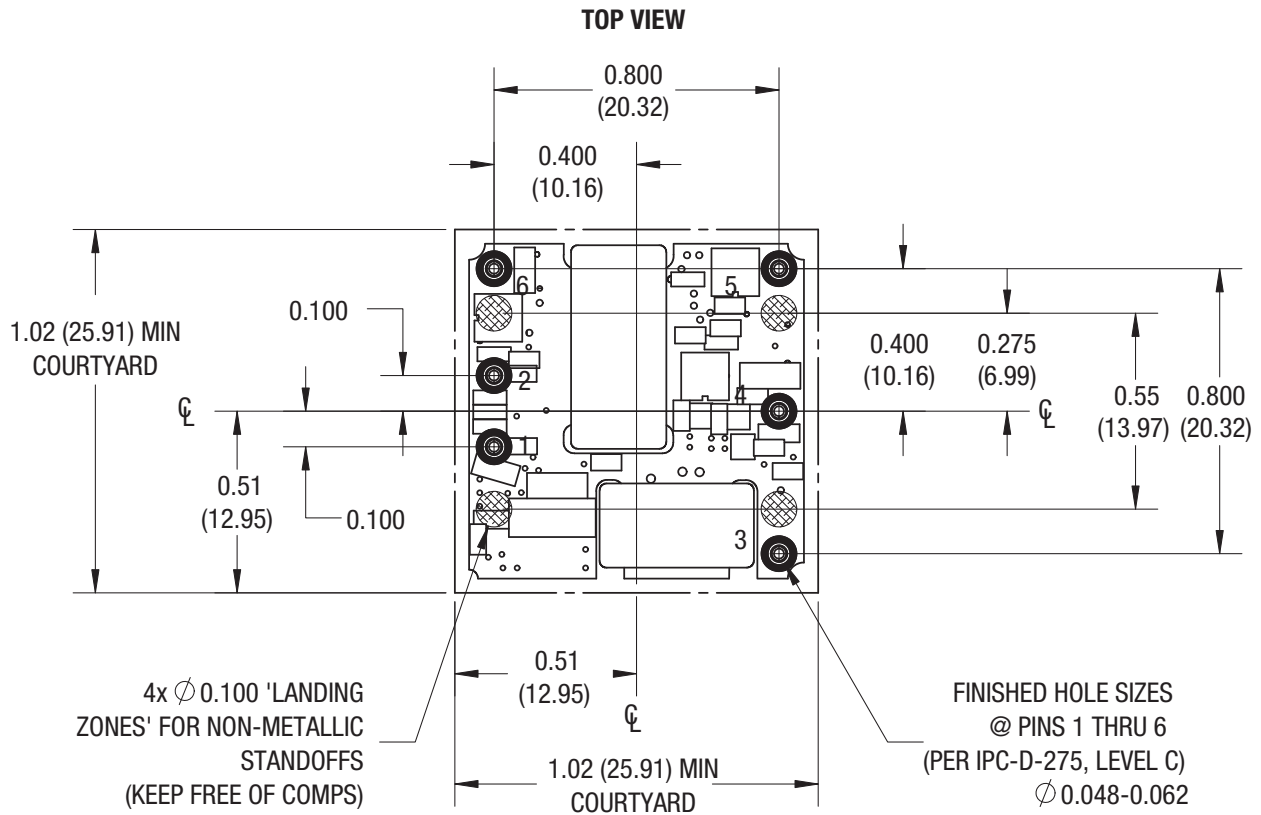

STANDARD PACKAGING

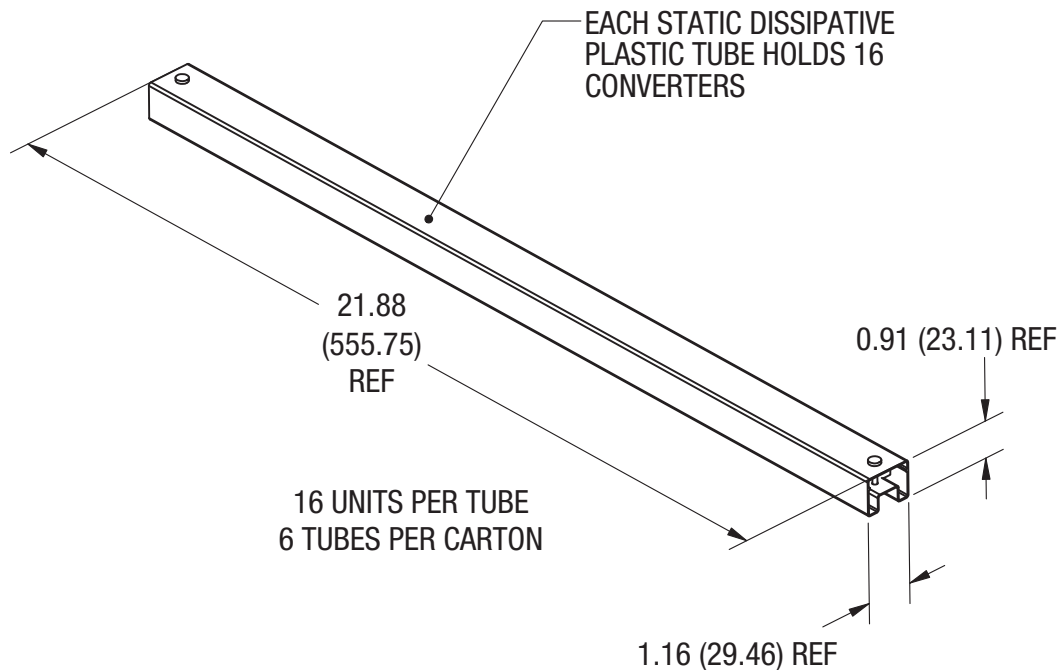



**TECHNICAL NOTES**

**Input Fusing**

Certain applications and/or safety agencies may require fuses at the inputs of power conversion components. Fuses should also be used when there is the possibility of sustained input voltage reversal which is not current-limited. For greatest safety, we recommend a fast blow fuse installed in the ungrounded input supply line.

The installer must observe all relevant safety standards and regulations. For safety agency approvals, install the converter in compliance with the end-user safety standard.

**Input Under-Voltage Shutdown and Start-Up Threshold**

Under normal start-up conditions, converters will not begin to regulate properly until the rising input voltage exceeds and remains at the Start-Up Threshold Voltage (see Specifications). Once operating, converters will not turn off until the input voltage drops below the Under-Voltage Shutdown Limit. Subsequent restart will not occur until the input voltage rises again above the Start-Up Threshold. This built-in hysteresis prevents any unstable on/off operation at a single input voltage.

Users should be aware however of input sources near the Under-Voltage Shutdown whose voltage decays as input current is consumed (such as capacitor inputs), the converter shuts off and then restarts as the external capacitor re-charges. Such situations could oscillate. To prevent this, make sure the operating input voltage is well above the UV Shutdown voltage AT ALL TIMES.

**Start-Up Delay**

Assuming that the output current is set at the rated maximum, the  $V_{in}$  to  $V_{out}$  Start-Up Delay (see Specifications) is the time interval between the point when the rising input voltage crosses the Start-Up Threshold and the fully loaded regulated output voltage enters and remains within its specified regulation band. Actual measured times will vary with input source impedance, external input capacitance, input voltage slew rate and final value of the input voltage as it appears at the converter.

These converters include a soft start circuit to moderate the duty cycle of the PWM controller at power up, thereby limiting the input inrush current.

The On/Off Remote Control interval from inception to  $V_{out}$  regulated assumes that the converter already has its input voltage stabilized above the Start-Up Threshold before the On command. The interval is measured from the On command until the output enters and remains within its specified regulation band. The specification assumes that the output is fully loaded at maximum rated current.

**Input Source Impedance**

These converters will operate to specifications without external components, assuming that the source voltage has very low impedance and reasonable input voltage regulation. Since real-world voltage sources have finite impedance, performance is improved by adding external filter components. Sometimes only a small ceramic capacitor is sufficient. Since it is difficult to totally characterize all applications, some experimentation may be needed. Note that external input capacitors must accept high speed switching currents.

Because of the switching nature of DC/DC converters, the input of these converters must be driven from a source with both low AC impedance and adequate DC input regulation. Performance will degrade with increasing input inductance. Excessive input inductance may inhibit operation. The DC input regulation specifies that the input voltage, once operating, must never degrade below the Shut-Down Threshold under all load conditions. Be sure to use adequate trace sizes and mount components close to the converter.

**I/O Filtering, Input Ripple Current and Output Noise**

All models in this converter series are tested and specified for input reflected ripple current and output noise using designated external input/output components, circuits and layout as shown in the figures below. External input capacitors ( $C_{in}$  in the figure) serve primarily as energy storage elements, minimizing line voltage variations caused by transient IR drops in the input conductors. Users should select input capacitors for bulk capacitance (at appropriate frequencies), low ESR and high RMS ripple current ratings. In the figure below, the  $C_{BUS}$  and  $L_{BUS}$  components simulate a typical DC voltage bus. Your specific system configuration may require additional considerations. Please note that the values of  $C_{in}$ ,  $L_{BUS}$  and  $C_{BUS}$  may vary according to the specific converter model.

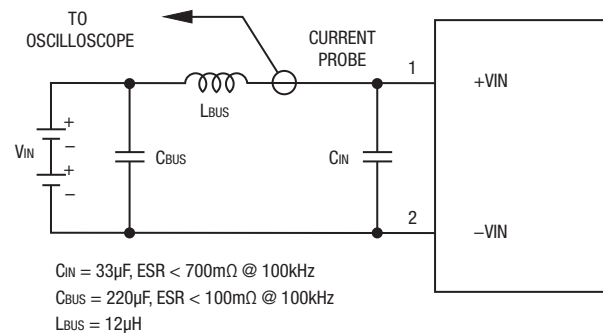

Figure 2. Measuring Input Ripple Current

In critical applications, output ripple and noise (also referred to as periodic and random deviations or PARD) may be reduced by adding filter elements such as multiple external capacitors. Be sure to calculate component temperature rise from reflected AC current dissipated inside capacitor ESR.

**Floating Outputs**

Since these are isolated DC/DC converters, their outputs are “floating” with respect to their input. The essential feature of such isolation is ideal ZERO CURRENT FLOW between input and output. Real-world converters however do exhibit tiny leakage currents between input and output (see Specifications). These leakages consist of both an AC stray capacitance coupling component and a DC leakage resistance. When using the isolation feature, do not allow the isolation voltage to exceed specifications. Otherwise the converter may be damaged. Designers will normally use the negative output (-Output) as the ground return of the load circuit. You can however use the positive output (+Output) as the ground return to effectively reverse the output polarity.

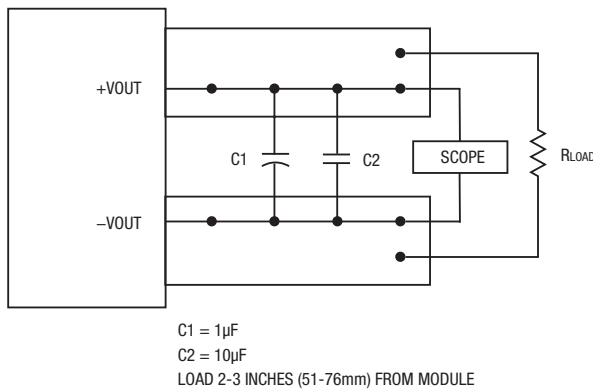

Figure 3. Measuring Output Ripple and Noise (PARD)

### Minimum Output Loading Requirements

These converters employ a synchronous rectifier design topology. All models regulate within specification and are stable from 0% load to full load conditions, unless otherwise specified. Operation under no load will not damage the converter but might, however, slightly increase regulation, output ripple, and noise.

### Thermal Shutdown

To protect against thermal over-stress, these converters include thermal shutdown circuitry. If environmental conditions cause the temperature of the DC/DC's to rise above the Operating Temperature Range up to the shutdown temperature, an on-board electronic temperature sensor will power down the unit. When the temperature decreases below the turn-on threshold, the converter will automatically restart. There is a small amount of hysteresis to prevent rapid on/off cycling. CAUTION: If you operate too close to the thermal limits, the converter may shut down suddenly without warning. Be sure to thoroughly test your application to avoid unplanned thermal shutdown.

### Temperature Derating Curves

The graphs in the performance data section illustrate typical operation under a variety of conditions. The Derating curves show the maximum continuous ambient air temperature and decreasing maximum output current which is acceptable under increasing forced airflow measured in Linear Feet per Minute ("LFM"). Note that these are AVERAGE measurements. The converter will accept brief increases in temperature and/or current or reduced airflow as long as the average is not exceeded.

Note that the temperatures are of the ambient airflow, not the converter itself which is obviously running at higher temperature than the outside air. Also note that "natural convection" is defined as very low flow rates which are not using fan-forced airflow. Depending on the application, "natural convection" is usually about 30-65 LFM but is not equal to still air (0 LFM).

Murata Power Solutions makes Characterization measurements in a closed cycle wind tunnel with calibrated airflow. We use both thermocouples and an infrared camera system to observe thermal performance. As a practical matter, it is quite difficult to insert an anemometer to precisely measure airflow in

most applications. Sometimes it is possible to estimate the effective airflow if you thoroughly understand the enclosure geometry, entry/exit orifice areas and the fan flowrate specifications.

CAUTION: If you exceed these Derating guidelines, the converter may have an unplanned Over Temperature shut down. Also, these graphs are all collected near Sea Level altitude. Be sure to reduce the derating for higher altitude.

### Output Overvoltage Protection (OVP)

This converter monitors its output voltage for an over-voltage condition using an on-board electronic comparator. The signal is optically coupled to the primary side PWM controller. If the output exceeds OVP limits, the sensing circuit will power down the unit, and the output voltage will decrease. After a time-out period, the PWM will automatically attempt to restart, causing the output voltage to ramp up to its rated value. It is not necessary to power down and reset the converter for this automatic OVP-recovery restart.

If the fault condition persists and the output voltage climbs to excessive levels, the OVP circuitry will initiate another shutdown cycle. This on/off cycling is referred to as "hiccup" mode.

### Output Current Limiting

As soon as the output current increases to approximately its overcurrent limit, the DC/DC converter will enter a current-limiting mode. The output voltage will decrease proportionally with increases in output current, thereby maintaining a somewhat constant power output. This is commonly referred to as power limiting.

Current limiting inception is defined as the point at which full power falls below the rated tolerance. See the Performance/Functional Specifications. Note particularly that the output current may briefly rise above its rated value. This enhances reliability and continued operation of your application. If the output current is too high, the converter will enter the short circuit condition.

### Output Short Circuit Condition

When a converter is in current-limit mode, the output voltage will drop as the output current demand increases. If the output voltage drops too low, the magnetically coupled voltage used to develop PWM bias voltage will also drop, thereby shutting down the PWM controller. Following a time-out period, the PWM will restart, causing the output voltage to begin rising to its appropriate value. If the short-circuit condition persists, another shutdown cycle will initiate. This on/off cycling is called "hiccup mode." The hiccup cycling reduces the average output current, thereby preventing excessive internal temperatures.

### Trimming the Output Voltage

The Trim input to the converter allows the user to adjust the output voltage over the rated trim range (please refer to the Specifications). In the trim equations and circuit diagrams that follow, trim adjustments use a single fixed resistor connected between the Trim input and either Vout pin. Trimming resistors should have a low temperature coefficient ( $\pm 100$  ppm/ $^{\circ}$ C or less) and be mounted close to the converter. Keep leads short. If the trim function is not used, leave the trim unconnected. With no trim, the converter will exhibit its specified output voltage accuracy.

There are two CAUTIONs to observe for the Trim input:

**CAUTION:** To avoid unplanned power down cycles, do not exceed EITHER the maximum output voltage OR the maximum output power when setting the trim. If the output voltage is excessive, the OVP circuit may inadvertently shut down the converter. If the maximum power is exceeded, the converter may enter current limiting. If the power is exceeded for an extended period, the converter may overheat and encounter overtemperature shut down.

**CAUTION:** Be careful of external electrical noise. The Trim input is a sensitive input to the converter's feedback control loop. Excessive electrical noise may cause instability or oscillation. Keep external connections short to the Trim input. Use shielding if needed.

### Trim Equations

| Trim Up   | Trim Down   |
|---|---|
| <b>SPM25-033-D48</b>                                |   |
| $R_{TUP} (\Omega) = \frac{12775}{V_o - 3.3} - 2050$ | $R_{TDOWN} (\Omega) = \frac{5110 \times (V_o - 2.5)}{3.3 - V_o} - 2050$ |
| <b>SPM25-050-D48</b>                                |   |
| $R_{TUP} (\Omega) = \frac{12775}{V_o - 5} - 2050$   | $R_{TDOWN} (\Omega) = \frac{5110 \times (V_o - 2.5)}{5 - V_o} - 2050$   |
| <b>SPM25-120-D48</b>                                |   |
| $R_{TUP} (\Omega) = \frac{25000}{V_o - 12} - 5110$  | $R_{TDOWN} (\Omega) = \frac{10000 (V_o - 2.5)}{12 - V_o} - 5110$        |

<Connect trim resistor between Trim and -Vout>

<Connect trim resistor between Trim and +Vout>

Where  $V_o$  = Desired output voltage. Adjustment accuracy is subject to resistor tolerances and factory-adjusted output accuracy. Mount trim resistor close to converter. Use short leads.

### Remote On/Off Control

On the input side, a remote On/Off Control can be specified with either positive or negative logic as follows:

**Positive:** Models equipped with Positive Logic are enabled when the On/Off pin is left open or is pulled high to +15V<sub>DC</sub> with respect to -V<sub>IN</sub>. An internal bias current causes the open pin to rise to +V<sub>IN</sub>. Positive-logic devices are disabled when the On/Off is grounded or brought to within a low voltage (see Specifications) with respect to -V<sub>IN</sub>.

**Negative:** Models with negative logic are on (enabled) when the On/Off is grounded or brought to within a low voltage (see Specifications) with respect to -V<sub>IN</sub>. The device is off (disabled) when the On/Off is left open or is pulled high to +15V<sub>DC</sub> Max. with respect to -V<sub>IN</sub>.

Dynamic control of the On/Off function should be able to sink the specified signal current when brought low and withstand specified voltage when brought high. Be aware too that there is a finite time in milliseconds (see Specifications) between the time of On/Off Control activation and stable, regulated output. This time will vary slightly with output load type and current and input conditions.

There are two CAUTIONs for the On/Off Control:

**CAUTION:** While it is possible to control the On/Off with external logic if you carefully observe the voltage levels, the preferred circuit is either an open drain/open collector transistor or a relay (which can thereupon be controlled by logic). The On/Off prefers to be set at approx. +15V (open pin) for the ON state, assuming positive logic.

**CAUTION:** Do not apply voltages to the On/Off pin when there is no input power voltage. Otherwise the converter may be permanently damaged.

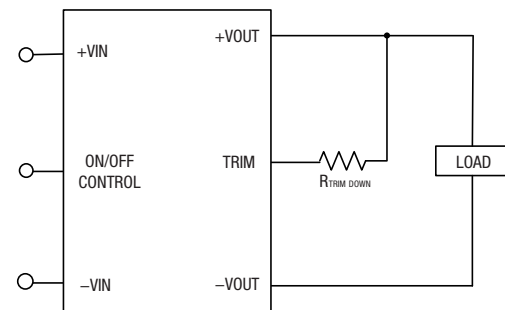

Figure 4. Trim adjustments to decrease Output Voltage using a Fixed Resistor

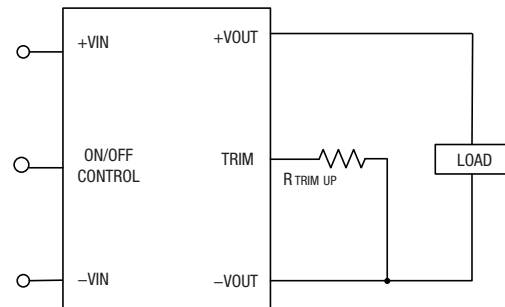

Figure 5. Trim adjustments to increase Output Voltage using a Fixed Resistor

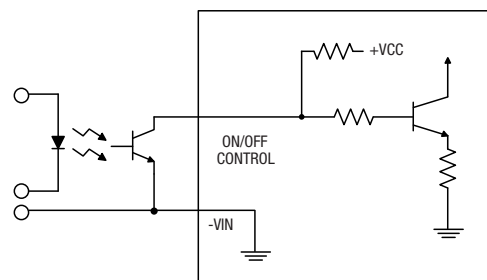

Figure 6. Driving the On/Off Control Pin (suggested circuit)

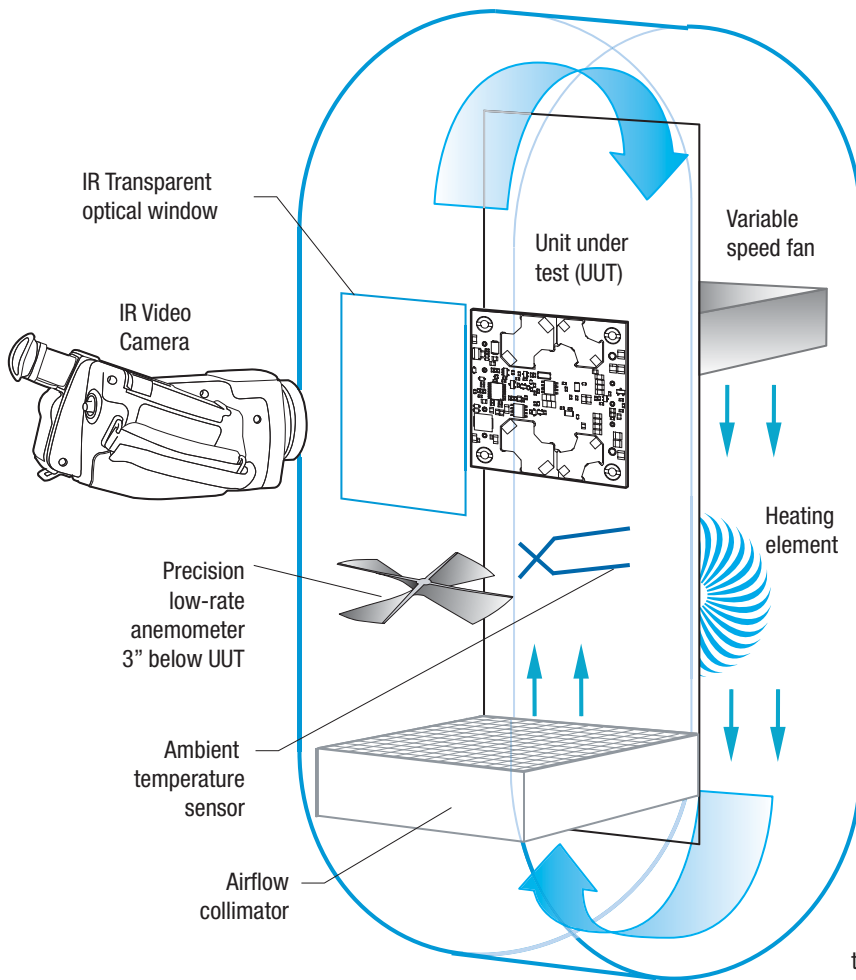

Figure 7. Vertical Wind Tunnel

**Vertical Wind Tunnel**

Murata Power Solutions employs a computer controlled custom-designed closed loop vertical wind tunnel, infrared video camera system, and test instrumentation for accurate airflow and heat dissipation analysis of power products. The system includes a precision low flow-rate anemometer, variable speed fan, power supply input and load controls, temperature gauges, and adjustable heating element.

The IR camera monitors the thermal performance of the Unit Under Test (UUT) under static steady-state conditions. A special optical port is used which is transparent to infrared wavelengths.

Both through-hole and surface mount converters are soldered down to a 10" X10" host carrier board for realistic heat absorption and spreading. Both longitudinal and transverse airflow studies are possible by rotation of this carrier board since there are often significant differences in the heat dissipation in the two airflow directions. The combination of adjustable airflow, adjustable ambient heat, and adjustable Input/Output currents and voltages mean that a very wide range of measurement conditions can be studied.

The collimator reduces the amount of turbulence adjacent to the UUT by minimizing airflow turbulence. Such turbulence influences the effective heat transfer characteristics and gives false readings. Excess turbulence removes more heat from some surfaces and less heat from others, possibly causing uneven overheating.

Both sides of the UUT are studied since there are different thermal gradients on each side. The adjustable heating element and fan, built-in temperature gauges, and no-contact IR camera mean that power supplies are tested in real-world conditions.

**Soldering Guidelines**

Murata Power Solutions recommends the specifications below when installing these converters. These specifications vary depending on the solder type. Exceeding these specifications may cause damage to the product. Be cautious when there is high atmospheric humidity. We strongly recommend a mild pre-bake (100° C. for 30 minutes). Your production environment may differ; therefore please thoroughly review these guidelines with your process engineers.

| Wave Solder Operations for through-hole mounted products (THMT) |           |                             |           |
|---|-----------|-----------------------------|-----------|
| For Sn/Ag/Cu based solders:                                     |           | For Sn/Pb based solders:    |           |
| Maximum Preheat Temperature                                     | 115° C.   | Maximum Preheat Temperature | 105° C.   |
| Maximum Pot Temperature   | 270° C.   | Maximum Pot Temperature     | 250° C.   |
| Maximum Solder Dwell Time                                       | 7 seconds | Maximum Solder Dwell Time   | 6 seconds |

Murata Power Solutions, Inc.  
11 Cabot Boulevard, Mansfield, MA 02048-1151 U.S.A.  
ISO 9001 and 14001 REGISTERED



**This product is subject to the following operating requirements and the Life and Safety Critical Application Sales Policy:**  
Refer to: <http://www.murata-ps.com/requirements/>

Murata Power Solutions, Inc. makes no representation that the use of its products in the circuits described herein, or the use of other technical information contained herein, will not infringe upon existing or future patent rights. The descriptions contained herein do not imply the granting of licenses to make, use, or sell equipment constructed in accordance therewith. Specifications are subject to change without notice. © 2015 Murata Power Solutions, Inc.

# Mouser Electronics

Authorized Distributor

Click to View Pricing, Inventory, Delivery & Lifecycle Information:

[Murata:](#)

[SPM25-033-D48N-C](#) [SPM25-120-D48N-C](#) [SPM25-033-D48-C](#) [SPM25-050-D48P-C](#) [SPM25-050-D48N-C](#) [SPM25-120-D48-C](#) [SPM25-033-D48P-C](#) [SPM25-050-D48-C](#) [SPM25-120-D48P-C](#)