

REVISIONS				
P	LW	DESCRIPTION	DATE	BY / APPR
B1		REVISED PER ECR-17-013047	12SEP2017	J.Z. D.Z.

- PARTS MUST COMPLY WITH AMP SOLDERABILITY SPECIFICATION 109-11-3.
- WIRE RANGE: 0.8 - 2.0 mm² [18 - 14 AWG].
- INSULATION RANGE: 2.29 - 3.81 [.090 - .150] DIAMETER
- FITS A 1.57 [.062] THICK P.C. BOARD.

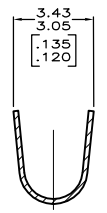

SECTION A-A

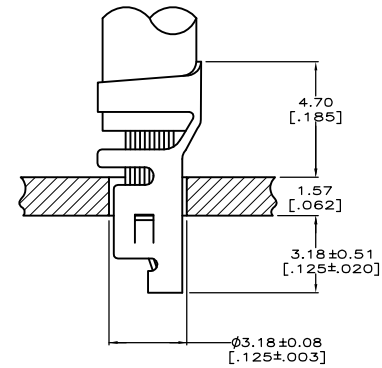
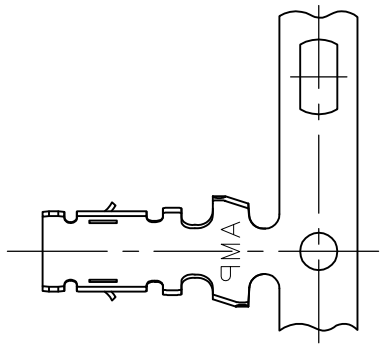
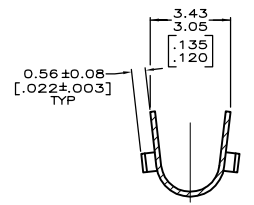

SECTION B-B

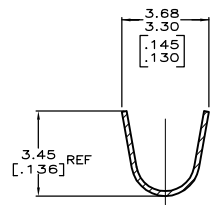
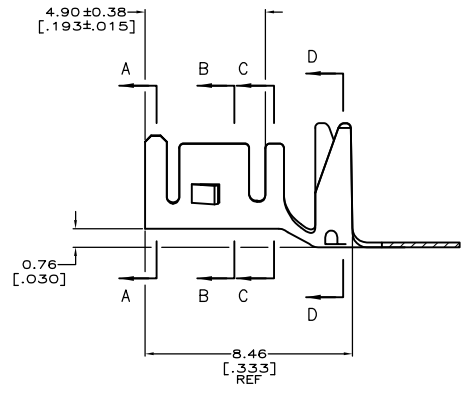

SECTION C-C

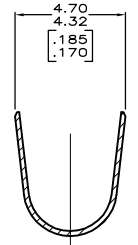

SECTION D-D

YES	0.00508	[.000200]	BRIGHT TIN	0.198	[.0078]	PH BRZ	3-647334-1
NO	0.00508	[.000200]	BRIGHT TIN-LEAD	0.198	[.0078]	PH BRZ	647334-1
LEAD FREE	FINISH			MATERIAL		PART NUMBER	

METRIC

THIS DRAWING IS A CONTROLLED DOCUMENT. BY: X. WHITAKER 130072004
 DATE: 130072004
 CHECKED BY: J. ELLIS 130072004
 DATE: 130072004
 PRODUCT SPEC: —
 APPLICATION SPEC: —
 WEIGHT: 0.000000
 CUSTOMER DRAWING: A1 00779 C-647334

TE TE Connectivity
 TERMINAL, MINI AMP-IN™ 2000

SIZE: A1 CASE CODE: 00779C DRAWING NO: 647334 SHEET 1 OF 1 REV B1

Mouser Electronics

Authorized Distributor

Click to View Pricing, Inventory, Delivery & Lifecycle Information:

[TE Connectivity:](#)

[647334-1](#)