

# FAN7527B

## Power Factor Correction Controller

### Features

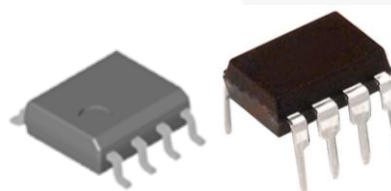
- Internal Startup Timer
- Internal R/C Filter Eliminates the Need for External R/C Filter
- Precise Adjustable Output Over-Voltage Protection
- Zero Current Detector
- One Quadrant Multiplier
- Trimmed 1.5% Internal Band Gap Reference
- Under-Voltage Lockout with 3 V of Hysteresis
- Totem-Pole Output with High-State Clamp
- Low Startup and Operating Current
- 8-Pin SOP or 8-Pin DIP

### Applications

- Electronic Ballast
- SMPS

### Description

The FAN7527B provides simple and high-performance active Power Factor Correction (PFC). The FAN7527B is optimized for electronic ballasts and low-power, high-density power supplies that require minimum board size, reduced external components, and low power dissipation. Because the R/C filter is included in the current-sense block, an external R/C filter is not necessary. Special circuitry prevents no-load runaway conditions. Regardless of the supply voltage, the output drive clamping circuit limits the overshoot of the power MOSFET gate drive, which improves system reliability.



### Ordering Information

Part Number	Operating Temperature Range	Package	Packing Method
FAN7527BMX	-25 to +125°C	8-Lead, Small Outline Package (SOP)	Tape and Reel
FAN7527BN	-25 to +125°C	8-Lead, Dual In-line Package (DIP)	Tube

Block Diagram

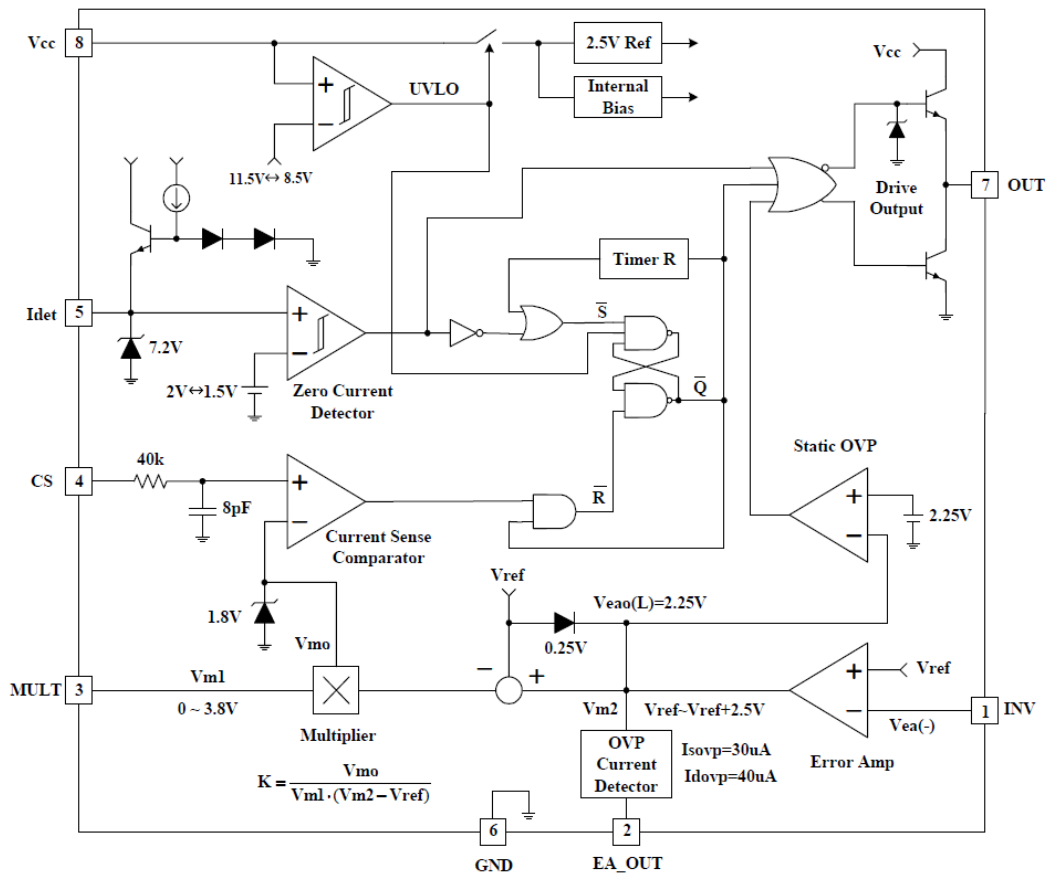


Figure 1. Block Diagram

## Pin Configuration

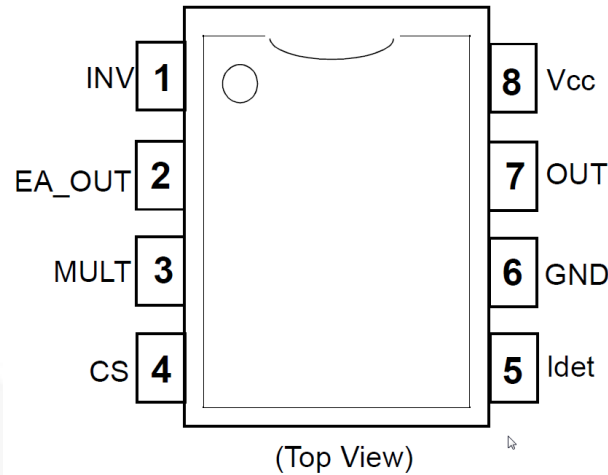


Figure 2. Pin Configuration

## Pin Definitions

Pin #	Name	Description
1	INV	Inverting input of the error amplifier. The output of the boost converter should be resistively divided to 2.5 V and connected to this pin.
2	EA_OUT	Output of the error amplifier. Feedback compensation network is placed between this pin and the INV pin.
3	MULT	Input to the multiplier stage. The full-wave rectified AC voltage is divided to less than 2 V and is connected to this pin.
4	CS	Input of the PWM comparator. The MOSFET current is sensed by a resistor and the resulting voltage is applied to this pin. An internal R/C filter is included to reject high-frequency noise.
5	Idet	Zero Current Detection (ZCD) input.
6	GND	Ground
7	OUT	Gate driver output. Push-pull output stage is able to drive the power MOSFET with a peak current of 500 mA.
8	V <sub>CC</sub>	Supply voltage of driver and control circuits.

## Absolute Maximum Ratings

Stresses exceeding the absolute maximum ratings may damage the device. The device may not function or be operable above the recommended operating conditions and stressing the parts to these levels is not recommended. In addition, extended exposure to stresses above the recommended operating conditions may affect device reliability. The absolute maximum ratings are stress ratings only.

Symbol	Parameter	Min.	Max.	Unit
$V_{CC}$	Supply Voltage		30	V
$I_{OH}, I_{OL}$	Peak Drive Output Current		$\pm 500$	mA
$I_{CLAMP}$	Driver Output Clamping Diodes $V_O > V_{CC}$ or $V_O < -0.3$ V		$\pm 10$	mA
$I_{DET}$	Detector Clamping Diodes		$\pm 10$	mA
$V_{IN}$	Error Amplifier Multiplier and Comparator Input Voltages	-0.3	6.0	V
$T_J$	Operation Junction Temperature		+150	$^{\circ}\text{C}$
$T_{OPR}$	Operating Temperature Range	-25	+125	$^{\circ}\text{C}$
$T_{STG}$	Storage Temperature Range	-65	+150	$^{\circ}\text{C}$
$P_D$	Power Dissipation	8-SOP	0.8	W
		8-DIP	1.1	W
$\Theta_{JA}$	Thermal Resistance Junction-Ambient	8-SOP	150	$^{\circ}\text{C}/\text{W}$
		8-DIP	110	$^{\circ}\text{C}/\text{W}$

## Temperature Characteristics

$-25^{\circ}\text{C} \leq T_A \leq 125^{\circ}\text{C}$ .

Symbol	Parameter	Min.	Typ.	Max.	Unit
$\Delta V_{REF}$	Temperature Stability Reference Voltage ( $V_{REF}$ )		20		mV
$\Delta K/\Delta T$	Temperature Stability for Multiplier Gain (K)		-0.2		% / $^{\circ}\text{C}$

## Electrical Characteristics

$V_{CC} = 14\text{ V}$ ,  $-25^{\circ}\text{C} \leq T_A \leq 125^{\circ}\text{C}$ , unless otherwise stated.

Symbol	Parameter	Conditions	Min.	Typ.	Max.	Unit
<b>Under-Voltage Lockout</b>						
$V_{th(st)}$	Start Threshold Voltage	$V_{CC}$ Increasing	10.5	11.5	12.5	V
$H_{Y(st)}$	UVLO Hysteresis		2	3	4	V
<b>Supply Current Section</b>						
$I_{ST}$	Startup Supply Current	$V_{CC} = V_{th(st)} - 0.2\text{ V}$	10	60	100	$\mu\text{A}$
$I_{CC}$	Operating Supply Current	Output Not Switching		3	6	mA
$I_{CC(OVP)}$	Operating Current at OVP	$V_{INV} = 3\text{ V}$		1.7	4.0	mA
$I_{DCC}$	Dynamic Operating Supply Current	50 kHz, $C_1 = 1\text{ nF}$		4	8	mA
<b>Error Amplifier Section</b>						
$V_{REF}$	Voltage Feedback Input Threshold	$I_{REF} = 0\text{ mA}$ , $T_A = 25^{\circ}\text{C}$	2.465	2.500	2.535	V
		$25^{\circ}\text{C} \leq T_A \leq 125^{\circ}\text{C}$	2.440	2.500	2.560	
$\Delta V_{FEF1}$	Line Regulation	$14\text{ V} \leq V_{CC} \leq 25\text{ V}$		0.1	10.0	mV
$\Delta V_{FEF3}$	Temperature Stability of $V_{REF}^{(1)}$	$-25^{\circ}\text{C} \leq T_A \leq 125^{\circ}\text{C}$		20		mV
$I_{b(ea)}$	Input Bias Current		-0.5		0.5	$\mu\text{A}$
$I_{SOURCE}$	Output Source Current	$V_{M2} = 4\text{ V}$	-2	-4		mA
$I_{SINK}$	Output Sink Current	$V_{M2} = 4\text{ V}$	2	4		mA
$V_{EAO(H)}$	Output Upper Clamp Voltage <sup>(1)</sup>	$I_{SOURCE} = 0.1\text{ mA}$		6		V
$V_{EAO(L)}$	Output Lower Clamp Voltage <sup>(1)</sup>	$I_{SINK} = 0.1\text{ mA}$		2.25		V
$G_V$	Large Signal Open-Loop Gain <sup>(1)</sup>		60	80		dB
PSRR	Power Supply Rejection Ratio <sup>(1)</sup>	$14\text{ V} \leq V_{CC} \leq 25\text{ V}$	60	80		dB
GBW	Unity Gain Bandwidth <sup>(1)</sup>			1		MHZ
SR	Slew Rate <sup>(1)</sup>			0.6		V/ $\mu\text{s}$
<b>Multiplier Section</b>						
$I_{b(m)}$	Input Bias Current (Pin 3)		-0.5		0.5	$\mu\text{A}$
$\Delta V_{M1}$	M1 Input Voltage Range (Pin 3)				3.8	V
$\Delta V_{M2}$	M2 Input Voltage Range (Pin 2)		$V_{REF}$		$V_{REF} + 2.5$	V
K	Multiplier Gain <sup>(1)</sup>	$V_{M1} = 1\text{ V}$ , $V_{M2} = 3.5\text{ V}$	0.36	0.44	0.52	1 / V
$V_{OMAX(m)}$	Maximum Multiplier Output Voltage	$V_{INV} = 0\text{ V}$ , $V_{M1} = 4\text{ V}$	1.65	1.80	1.95	V
$\Delta K/\Delta T$	Temperature Stability of K <sup>(1)</sup>	$-25 \leq T_A \leq 125^{\circ}\text{C}$		-0.2		% / $^{\circ}\text{C}$
<b>Current Sense Section</b>						
$V_{IO(CS)}$	Input Offset Voltage <sup>(1)</sup>	$V_{M1} = 0\text{ V}$ , $V_{M2} = 2.2\text{ V}$	-10	3	10	mV
$I_{b(CS)}$	Input Bias Current	$0\text{ V} \leq V_{CS} \leq 1.7\text{ V}$	-1.0	-0.1	1.0	$\mu\text{A}$
$t_{D(CS)}$	Current Sense Delay to Output <sup>(1)</sup>			200	500	ns

Continued on the following page...

**Electrical Characteristics** (Continued)

$V_{CC} = 14\text{ V}$ ,  $-25^{\circ}\text{C} \leq T_A \leq 125^{\circ}\text{C}$ , unless otherwise stated.

Symbol	Parameter	Conditions	Min.	Typ.	Max.	Unit
<b>Zero Current Detect Section</b>						
$V_{TH(DET)}$	Input Voltage Threshold	$V_{DET}$ Increasing	1.7	2.0	2.3	V
$H_{Y(DET)}$	Detect Hysteresis		0.2	0.5	0.8	V
$V_{CLAMP(L)}$	Input Low Clamp Voltage	$I_{DET} = -100\ \mu\text{A}$	0.45	0.75	1.00	V
$V_{CLAMP(H)}$	Input High Clamp Voltage	$I_{DET} = 3\ \text{mA}$	6.5	7.2	7.9	V
$I_{b(DET)}$	Input Bias Current	$1\ \text{V} \leq V_{DET} \leq 5\ \text{V}$	-1.0	-0.1	1.0	$\mu\text{A}$
$I_{CLAMP(D)}$	Input High/Low Clamp Diode Current <sup>(1)</sup>				$\pm 3$	mA
<b>Output Section</b>						
$V_{OH}$	Output Voltage High	$I_O = -10\ \text{mA}$	10.5	11.0		V
$V_{OL}$	Output Voltage Low	$I_O = 10\ \text{mA}$		0.8	1.0	V
$t_R$	Rising Time <sup>(1)</sup>	$C_L = 1\ \text{nF}$		130	200	ns
$t_F$	Falling Time <sup>(1)</sup>	$C_L = 1\ \text{nF}$		50	120	ns
$V_{OMAX(O)}$	Maximum Output Voltage	$V_{CC} = 20\ \text{V}$ , $I_O = 100\ \mu\text{A}$	12	14	16	V
$V_{OMIN(O)}$	Output Voltage with UVLO Activated	$V_{CC} = 5\ \text{V}$ , $I_O = 100\ \mu\text{A}$			1	V
<b>Restart Timer Section</b>						
$t_{D(RST)}$	Restart Time Delay	$V_{M1} = 1\ \text{V}$ , $V_{M2} = 3.5\ \text{V}$		150		$\mu\text{s}$
<b>Over-Voltage Protection Section</b>						
$I_{SOVP}$	Soft OVP Detecting Current		25	30	35	$\mu\text{A}$
$I_{DOVP}$	Dynamic OVP Detecting Current		35	40	45	$\mu\text{A}$
$V_{OVP}$	Static OVP Threshold Voltage	$V_{INV} = 2.7\ \text{V}$	2.10	2.25	2.40	V

**Note:**

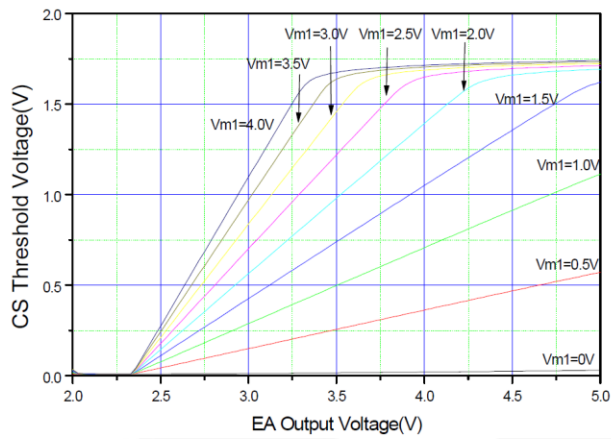
- These parameters, although guaranteed, are not 100% tested in production.

Multiplier Gain:

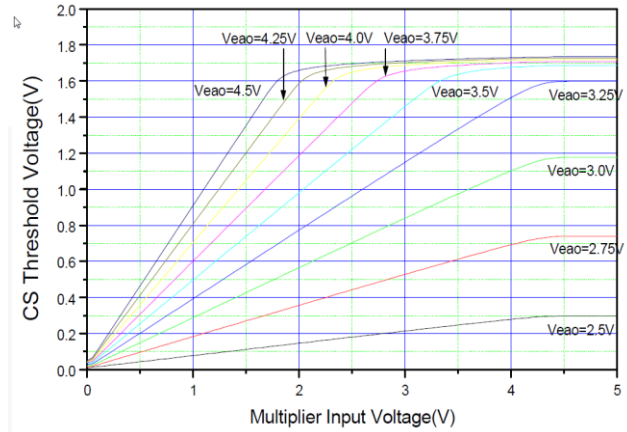
$$K = \frac{Pin4\_Threshold}{V_{M1} \times (V_{M2} - V_{REF})}$$

where  $V_{M1} = V_{PIN3}$ ,  $V_{M2} = V_{PIN2}$

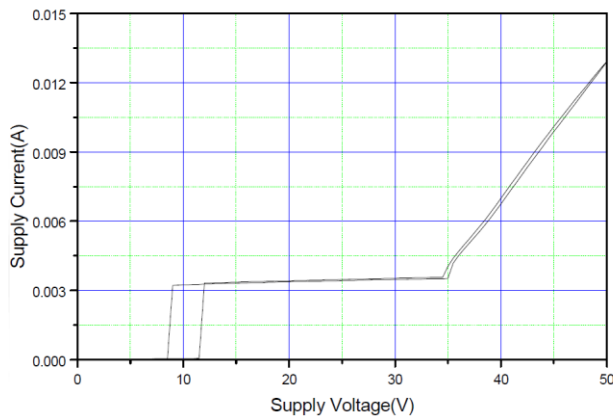
## Typical Performance Characteristics



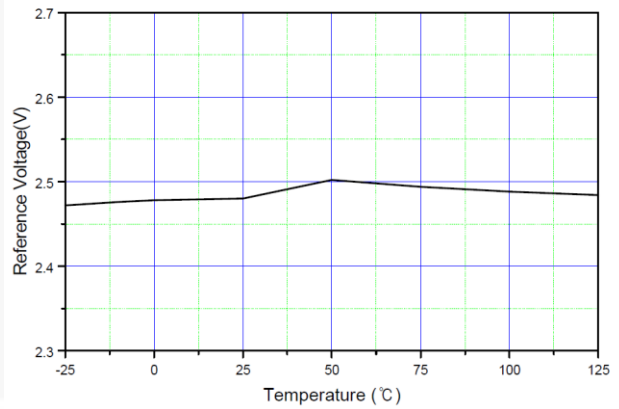
**Figure 3. Error Amplifier Output Voltage vs. Current Sensing Threshold**



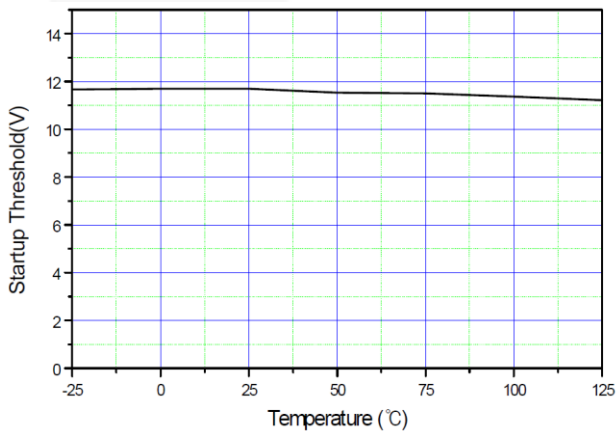
**Figure 4. Multiplier Input Voltage vs. Current Sensing Threshold**



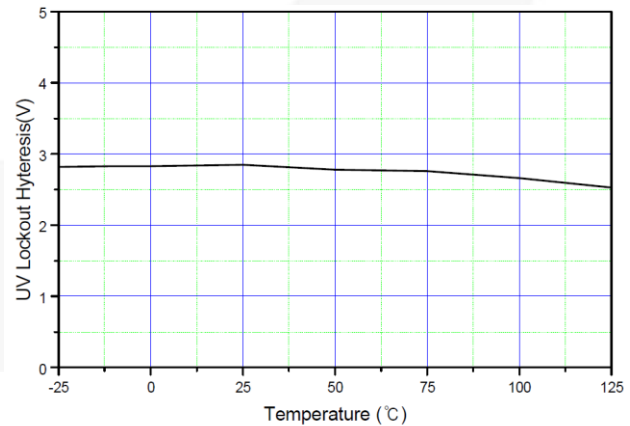
**Figure 5. Supply Current vs. Supply Voltage**



**Figure 6. Reference Voltage vs. Temperature**



**Figure 7. Startup Threshold vs. Temperature**



**Figure 8. UVLO Hysteresis vs. Temperature**

Typical Performance Characteristics (Continued)

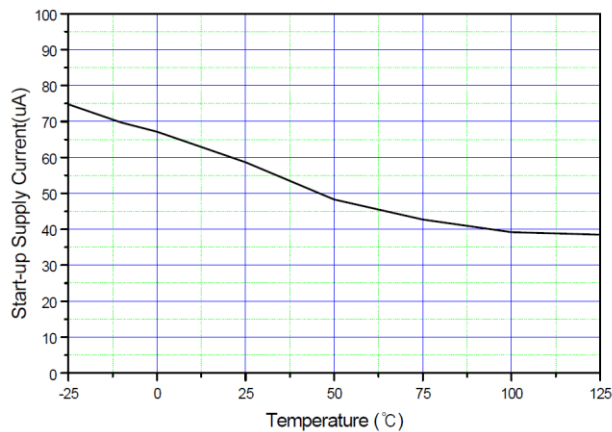


Figure 9. Startup Supply Current vs. Temperature

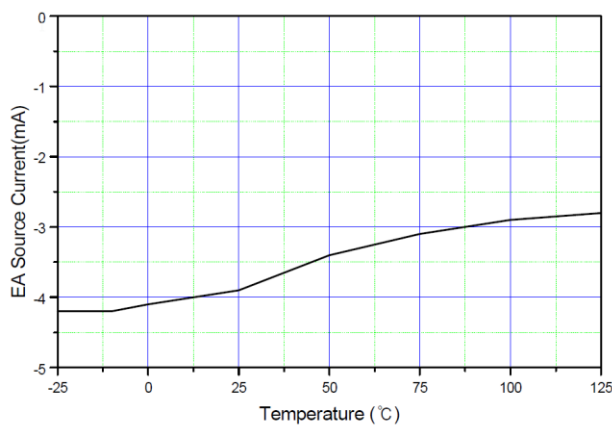


Figure 10. Error Amplifier Source Current

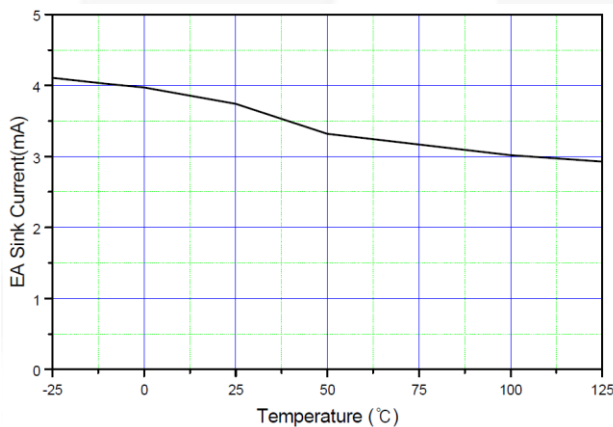


Figure 11. Error Amplifier Sink Current vs. Temperature

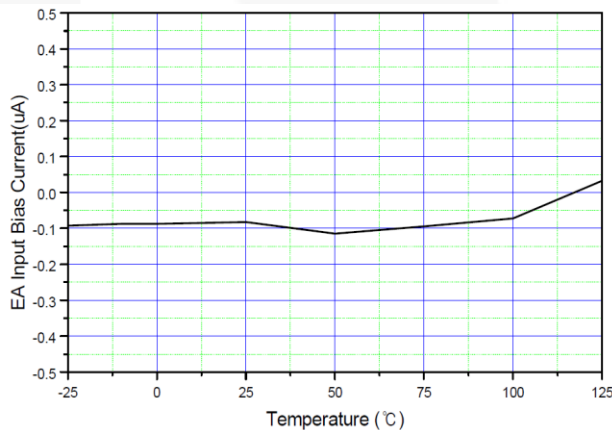


Figure 12. Error Amplifier Input Bias Current vs. Temperature

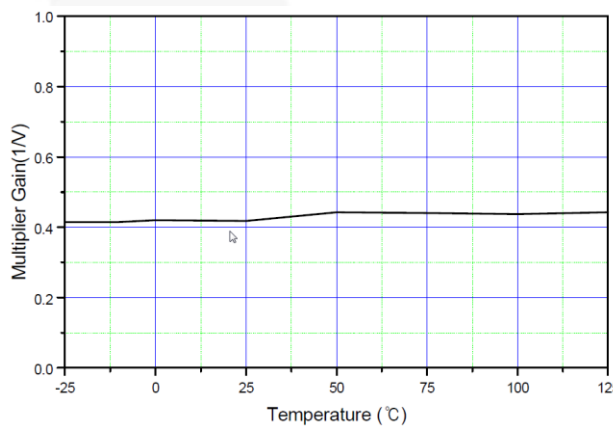


Figure 13. Multiplier Gain vs. Temperature

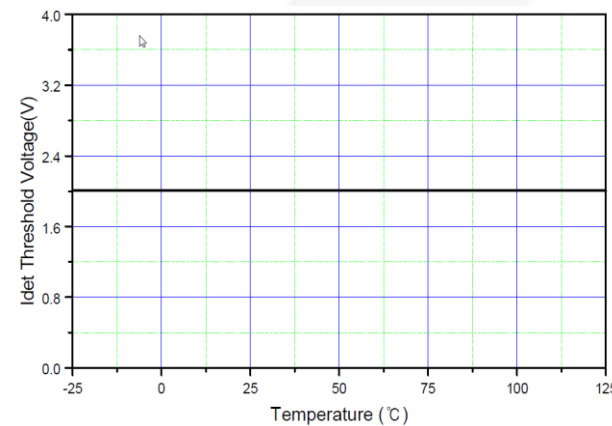
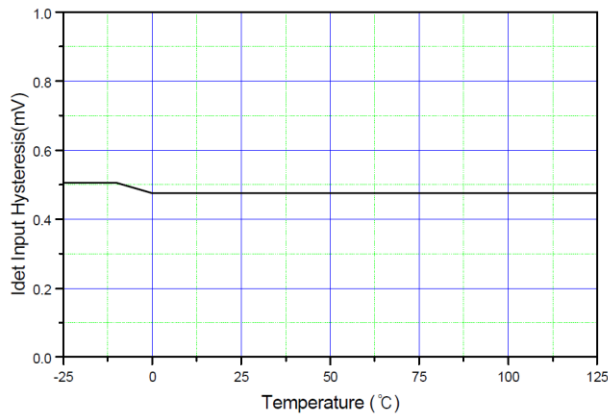


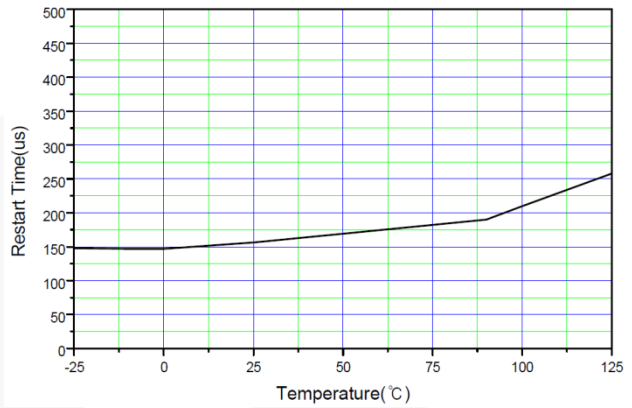
Figure 14.  $I_{DET}$  Threshold Voltage vs. Threshold



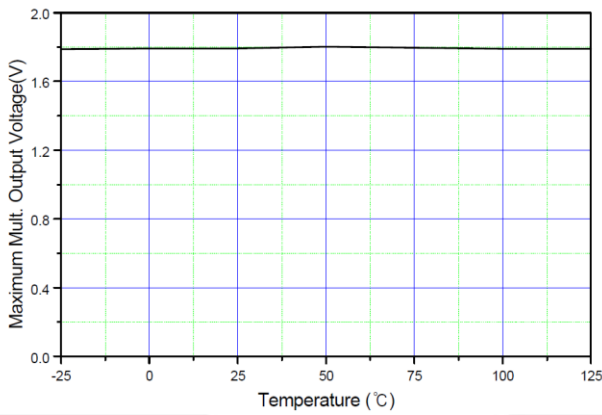
**Typical Performance Characteristics** (Continued)



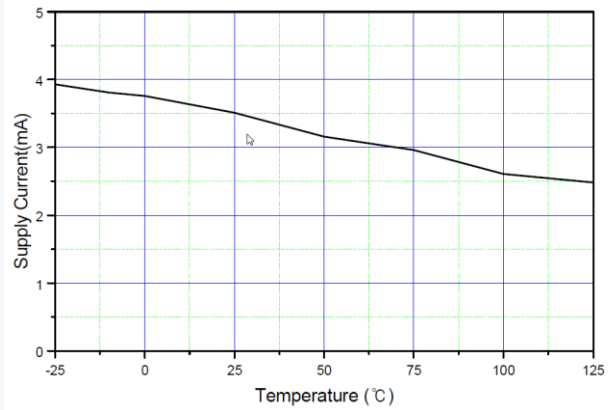
**Figure 15. IDET Input Hysteresis vs. Temperature**



**Figure 16. Restart Time vs. Temperature**

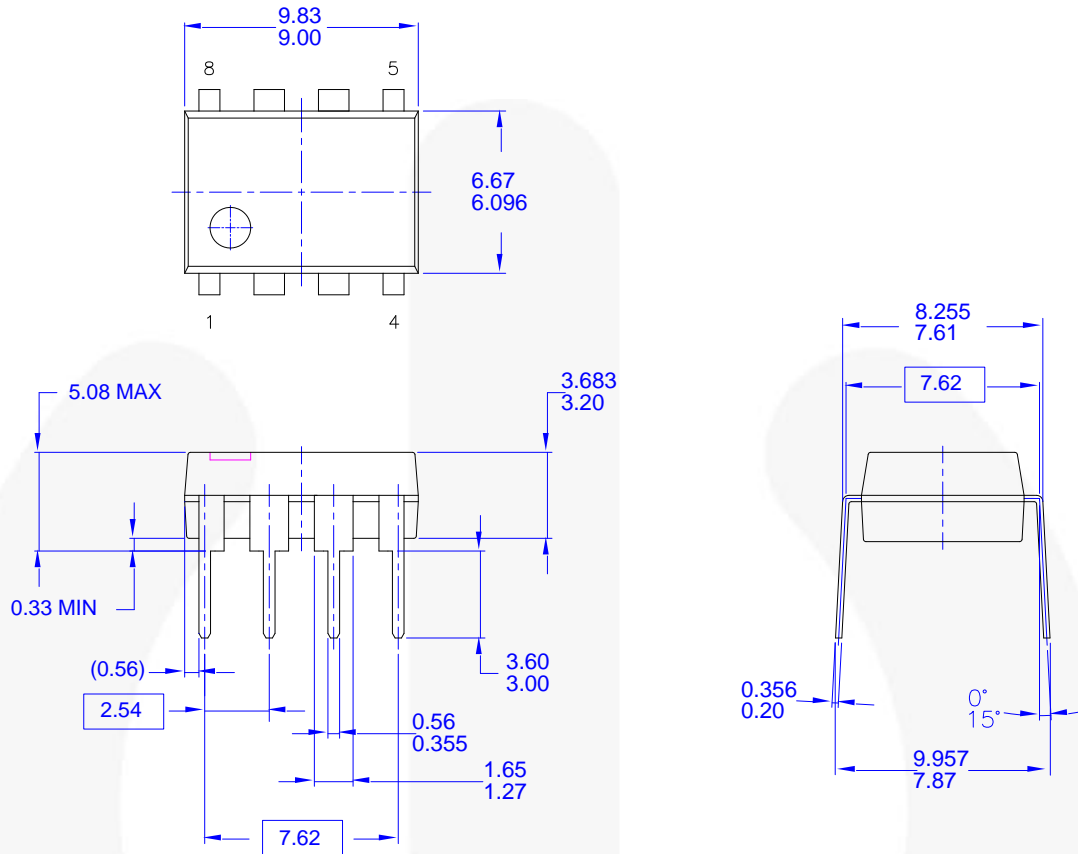


**Figure 17. Maximum Multiplier Output Voltage vs. Temperature**



**Figure 18. Supply Current vs. Temperature**

Physical Dimensions



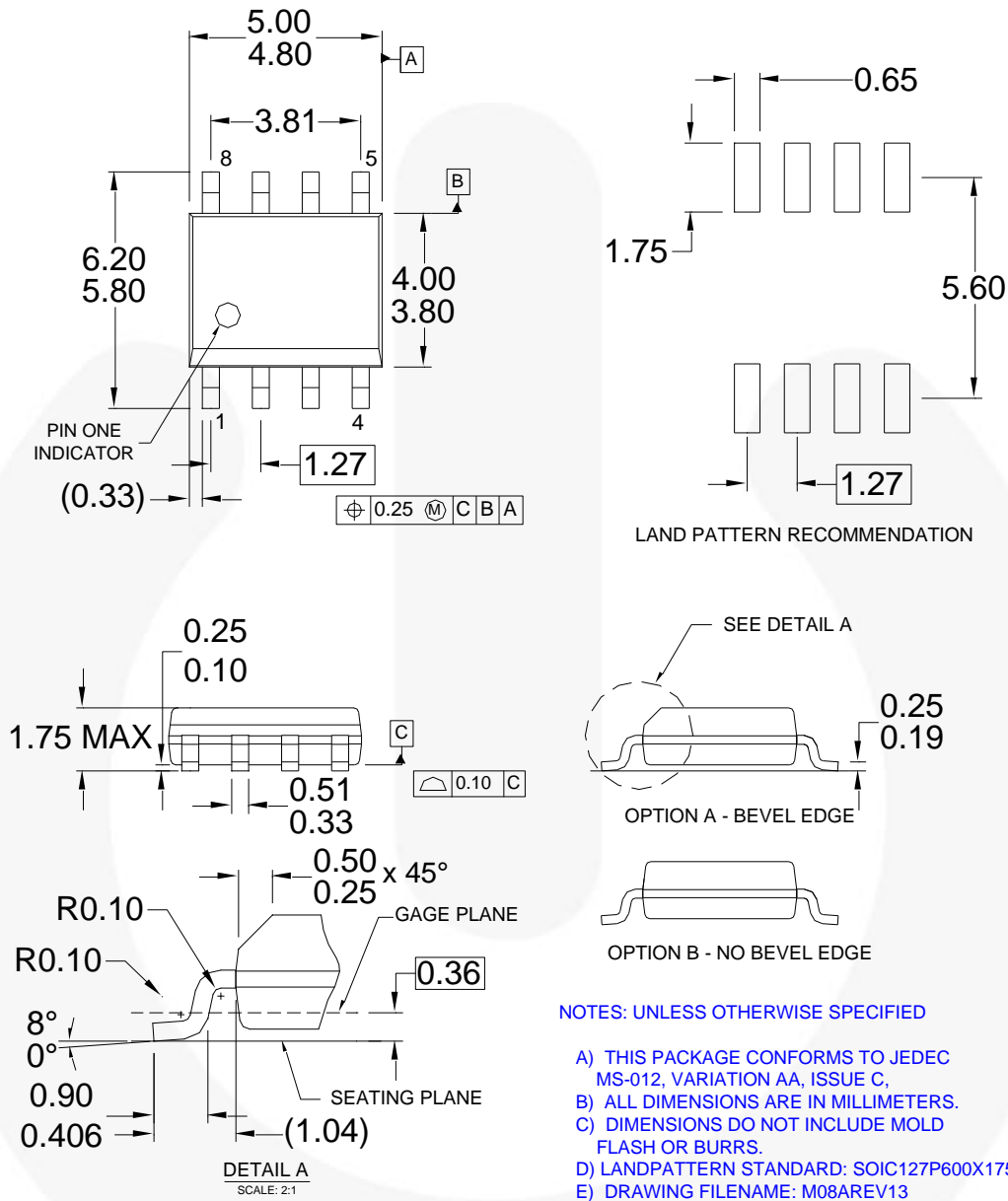
- NOTES: UNLESS OTHERWISE SPECIFIED
- A) THIS PACKAGE CONFORMS TO JEDEC MS-001 VARIATION BA
  - B) ALL DIMENSIONS ARE IN MILLIMETERS.
  - C) DIMENSIONS ARE EXCLUSIVE OF BURRS, MOLD FLASH, AND TIE BAR EXTRUSIONS.
  - D) DIMENSIONS AND TOLERANCES PER ASME Y14.5M-1994
  - E) DRAWING FILENAME AND REVISION: MKT-N08FREV2.

Figure 19. 8-Lead, MDIP, .300" Wide, Two DAP

Package drawings are provided as a service to customers considering Fairchild components. Drawings may change in any manner without notice. Please note the revision and/or date on the drawing and contact a Fairchild Semiconductor representative to verify or obtain the most recent revision. Package specifications do not expand the terms of Fairchild's worldwide terms and conditions, specifically the warranty therein, which covers Fairchild products.

Always visit Fairchild Semiconductor's online packaging area for the most recent package drawings:  
<http://www.fairchildsemi.com/packaging/>.

### Physical Dimensions (8-SOP)



**Figure 20. 8-Lead, Small Outline Package**

Package drawings are provided as a service to customers considering Fairchild components. Drawings may change in any manner without notice. Please note the revision and/or date on the drawing and contact a Fairchild Semiconductor representative to verify or obtain the most recent revision. Package specifications do not expand the terms of Fairchild's worldwide terms and conditions, specifically the warranty therein, which covers Fairchild products.

Always visit Fairchild Semiconductor's online packaging area for the most recent package drawings:  
<http://www.fairchildsemi.com/packaging/>.



**TRADEMARKS**

The following includes registered and unregistered trademarks and service marks, owned by Fairchild Semiconductor and/or its global subsidiaries, and is not intended to be an exhaustive list of all such trademarks.

- |   |  |   |   |
|---|--|---|---|
| 2Cool™  | FPS™   |  | Sync-Lock™  |
| AccuPower™  | F-PFS™   | PowerTrench®  |  |
| AX-CAP®   | FRFET®   | PowerXS™  | TinyBoost™  |
| BitSiC™   | Global Power Resource™                         | Programmable Active Droop™  | TinyBuck™   |
| Build it Now™   | GreenBridge™                                   | QFET®   | TinyCalc™   |
| CorePLUS™   | Green FPS™                                     | QST™  | TinyLogic®  |
| CorePOWER™  | Green FPS™ e-Series™                           | Quiet Series™   | TINYOPTO™   |
| CROSSVOLT™  | Gmax™  | RapidConfigure™   | TinyPower™  |
| CTL™  | GTO™   |  | TinyPWM™  |
| Current Transfer Logic™   | IntelliMAX™                                    | Saving our world, 1mW/kW at a time™   | TinyWire™   |
| DEUXPEED®   | ISOPLANAR™                                     | SignalWise™   | TransiC™  |
| Dual Cool™  | Making Small Speakers Sound Louder and Better™ | SmartMax™   | TriFault Detect™  |
| EcoSPARK®   | MegaBuck™                                      | SMART START™  | TRUECURRENT®  |
| EfficientMax™   | MICROCOUPLER™                                  | Solutions for Your Success™   | μSerDes™  |
| ESBC™   | MicroFET™                                      | SPM®  |  |
|  | MicroPak™                                      | STEALTH™  | UHC®  |
| Fairchild®  | MicroPak2™                                     | SuperFET®   | Ultra FRFET™  |
| Fairchild Semiconductor®  | MillerDrive™                                   | SuperSOT™-3   | UniFET™   |
| FACT Quiet Series™  | MotionMax™                                     | SuperSOT™-6   | VCX™  |
| FACT®   | mWSaver™                                       | SuperSOT™-8   | VisualMax™  |
| FAST®   | OptoHiT™                                       | SupreMOS®   | VoltagePlus™  |
| FastvCore™  | OPTOLOGIC®                                     | SyncFET™  | XST™  |
| FETBench™   | OPTOPLANAR®                                    |   |   |

\* Trademarks of System General Corporation, used under license by Fairchild Semiconductor.

**DISCLAIMER**

FAIRCHILD SEMICONDUCTOR RESERVES THE RIGHT TO MAKE CHANGES WITHOUT FURTHER NOTICE TO ANY PRODUCTS HEREIN TO IMPROVE RELIABILITY, FUNCTION, OR DESIGN. FAIRCHILD DOES NOT ASSUME ANY LIABILITY ARISING OUT OF THE APPLICATION OR USE OF ANY PRODUCT OR CIRCUIT DESCRIBED HEREIN; NEITHER DOES IT CONVEY ANY LICENSE UNDER ITS PATENT RIGHTS, NOR THE RIGHTS OF OTHERS. THESE SPECIFICATIONS DO NOT EXPAND THE TERMS OF FAIRCHILD'S WORLDWIDE TERMS AND CONDITIONS, SPECIFICALLY THE WARRANTY THEREIN, WHICH COVERS THESE PRODUCTS.

**LIFE SUPPORT POLICY**

FAIRCHILD'S PRODUCTS ARE NOT AUTHORIZED FOR USE AS CRITICAL COMPONENTS IN LIFE SUPPORT DEVICES OR SYSTEMS WITHOUT THE EXPRESS WRITTEN APPROVAL OF FAIRCHILD SEMICONDUCTOR CORPORATION.

As used herein:

1. Life support devices or systems are devices or systems which, (a) are intended for surgical implant into the body or (b) support or sustain life, and (c) whose failure to perform when properly used in accordance with instructions for use provided in the labeling, can be reasonably expected to result in a significant injury of the user.
2. A critical component in any component of a life support, device, or system whose failure to perform can be reasonably expected to cause the failure of the life support device or system, or to affect its safety or effectiveness.

**ANTI-COUNTERFEITING POLICY**

Fairchild Semiconductor Corporation's Anti-Counterfeiting Policy. Fairchild's Anti-Counterfeiting Policy is also stated on our external website, [www.fairchildsemi.com](http://www.fairchildsemi.com), under Sales Support.

Counterfeiting of semiconductor parts is a growing problem in the industry. All manufacturers of semiconductor products are experiencing counterfeiting of their parts. Customers who inadvertently purchase counterfeit parts experience many problems such as loss of brand reputation, substandard performance, failed applications, and increased cost of production and manufacturing delays. Fairchild is taking strong measures to protect ourselves and our customers from the proliferation of counterfeit parts. Fairchild strongly encourages customers to purchase Fairchild parts either directly from Fairchild or from Authorized Fairchild Distributors who are listed by country on our web page cited above. Products customers buy either from Fairchild directly or from Authorized Fairchild Distributors are genuine parts, have full traceability, meet Fairchild's quality standards for handling and storage and provide access to Fairchild's full range of up-to-date technical and product information. Fairchild and our Authorized Distributors will stand behind all warranties and will appropriately address any warranty issues that may arise. Fairchild will not provide any warranty coverage or other assistance for parts bought from Unauthorized Sources. Fairchild is committed to combat this global problem and encourage our customers to do their part in stopping this practice by buying direct or from authorized distributors.

**PRODUCT STATUS DEFINITIONS**

**Definition of Terms**

Datasheet Identification	Product Status	Definition
Advance Information	Formative / In Design	Datasheet contains the design specifications for product development. Specifications may change in any manner without notice.
Preliminary	First Production	Datasheet contains preliminary data; supplementary data will be published at a later date. Fairchild Semiconductor reserves the right to make changes at any time without notice to improve design.
No Identification Needed	Full Production	Datasheet contains final specifications. Fairchild Semiconductor reserves the right to make changes at any time without notice to improve the design.
Obsolete	Not In Production	Datasheet contains specifications on a product that is discontinued by Fairchild Semiconductor. The datasheet is for reference information only.

Rev. I64

# Mouser Electronics

Authorized Distributor

Click to View Pricing, Inventory, Delivery & Lifecycle Information:

[ON Semiconductor:](#)

[FAN7527](#)