

- NOTES:
- MATERIAL: HSG: MATERIAL: -SEE PART NO. SCHEME ,UL94V0,HALOGEN FREE. COLOUR: -NATURAL.
 - CONTACT : MATERIAL: BRASS. PLATING: 50u" SEMI BRIGHT NICKEL UNDER PLATED. OPTIONAL PLATING ON CONTACT AREA. PICK & PLACE CAP: HIGH TEMP. THERMOPLASTIC
 - REFER GS-20-0401 APPLICATION SPEC FOR MATING CONNECTOR.
 - PRODUCT SPECIFICATION: GS-12-1181.
 - PACKAGE SPECIFICATION: GS-14-2362.
 - APPLICATION SPECIFICATION: GS-20-0401
 - THE HOUSING WILL WITHSTAND EXPOSURE TO 260°C PEAK TEMPERATURE FOR 5 SECONDS IN A WAVE SOLDER APPLICATION WITH A 1.6mm MINIMUM THICK CIRCUIT BOARD. (FOR NYLON)
 - THE HOUSING WILL WITHSTAND EXPOSURE TO 260°C PEAK TEMPERATURE FOR 10 SECONDS IN A REFLOW OVEN. (FOR LCP ONLY)
 - CERTIFICATION: ROHS , UL & CSA
 - THIS LF PRODUCT MEETS EUROPEAN UNION DIRECTIVES AND OTHER COUNTRY REGULATIONS AS DESCRIBED IN GS-47-0004
 - PART NUMBER SCHEME:
10127820-XX X X X X LF

DIMENSIONAL & PART NO. TABLE:

PART NUMBER	POS.	A	B
10127820-02XXXXXL	02	4.2	5.4
10127820-04XXXXXL	04	8.4	9.6
10127820-06XXXXXL	06	12.6	13.8
10127820-08XXXXXL	08	16.8	18.0
10127820-10XXXXXL	10	21.0	22.2
10127820-12XXXXXL	12	25.2	26.4
10127820-14XXXXXL	14	29.4	30.6
10127820-16XXXXXL	16	33.6	34.8
10127820-18XXXXXL	18	37.8	39.0
10127820-20XXXXXL	20	42.0	43.2
10127820-22XXXXXL	22	46.2	47.4
10127820-24XXXXXL	24	50.4	51.6

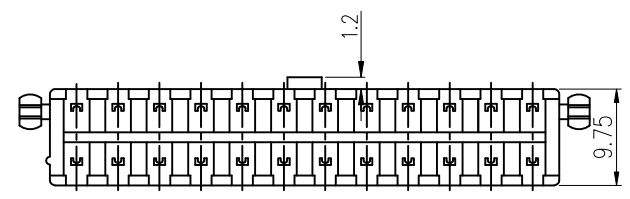
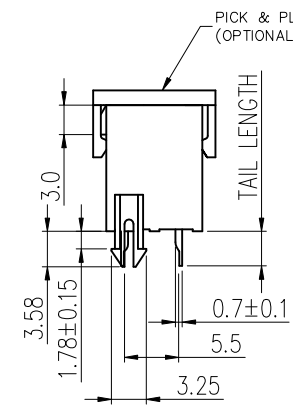
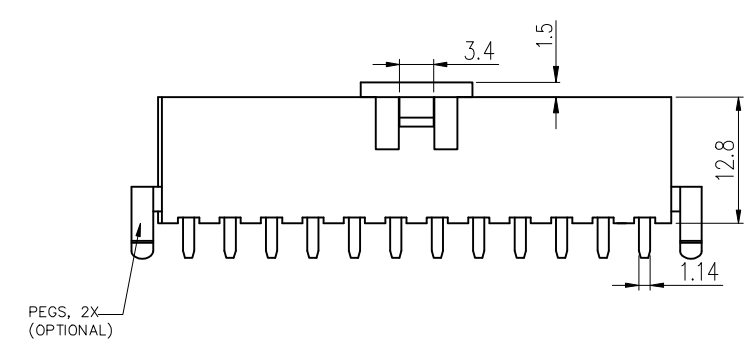
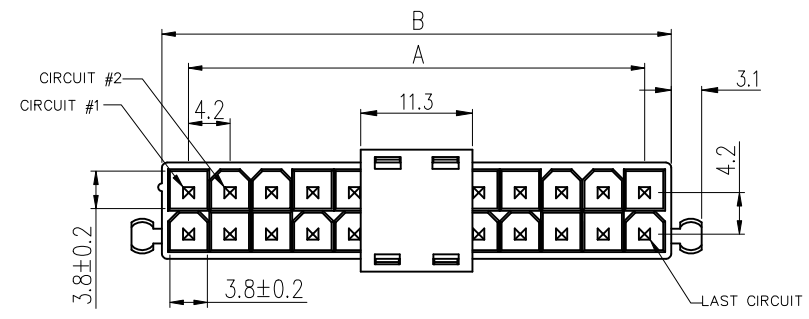

- POS. CODE:
02: 2 POS.
04: 4 POS.
24: 24 POS.
- TAIL LENGTH:
2: 3.5mm
3: 1.9mm
- PLATING CODE:
1: GOLD FLASH OVERALL
2: 80u" MIN BRIGHT TIN OVERALL
4: 30u" Au ON CONTACT AREA AND 100u" MIN BRIGHT TIN ON SOLDER TAILS
S: GOLD FLASH ON CONTACT AREA, 100u" MATTE TIN ON SOLDER TAILS
5: 100u" MIN MATTE TIN OVERALL
- LEAD FREE
- PACKAGING
BLANK: NO CAP, TRAY PACKAGE
C: WITH CAP, TAPE/REEL PACKAGE
T: NO CAP, TAPE/REEL PACKAGE
- PEG:
BLANK: NO PEG
P: 2 PEGS
- HOUSING MATERIAL AND GLOW WIRE COMPATIBILITY:
BLANK: PA66, NON COMPATIBLE
G: NYLON, COMPATIBLE
L: LCP, COMPATIBLE
B: LCP, BLACK COMPATIBLE

mat'l. code		surface		tolerance		projection	product family	
		ISO 1302		ISO 406 ISO 1101			MinitekPWR 4.2	
ltr	ecn no	dr	date	tolerances unless otherwise specified		mm	title	
J	ELX-T-21113	TAI	2015-06-08	angles	linear		MINITEK PWR4.2,WTB STANDARD HEADER, DUAL ROW,VT,DIP TYPE	
K	ELX-T-21843	TAI	2016-06-02			scaleN.T.S	dwg no	
L	ELX-T-26123	TAI	2017-02-20	0°±1°			sheet 1 of 3 size	
M	ELX-N-26497	TONY	2017-03-29	dr	TAI	2013-11-11		
N	ELX-N-28165	TONY	2017-10-16	enr	SONY	2023-01-09		
P	ELX-N-30477	TONY	2018-06-15	chr	SONY	2023-01-09		
R	ELX-I-43510	SONY	2023-01-09	appd	MITHUN	2023-01-09		
sheet	revision	R	R	R		Amphenol FCI		
index	sheet	1	2	3				

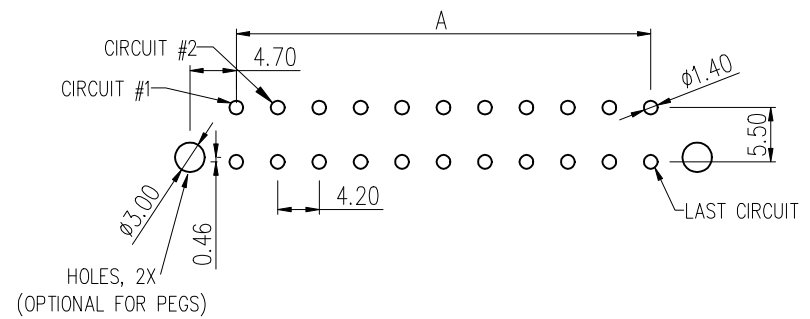
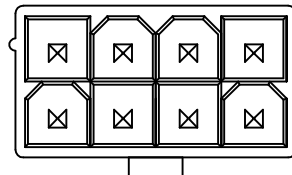

PCB LAYOUT COMPONENT SIDE
THICKNESS:1.6, TOLERANCE:±0.05

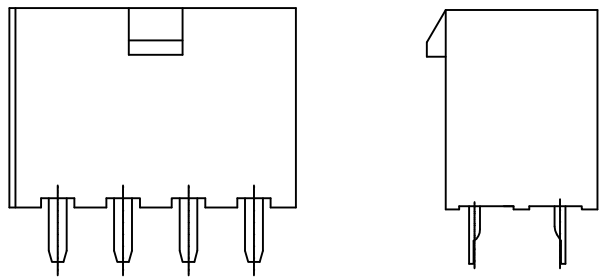

PART WITHOUT PEGS

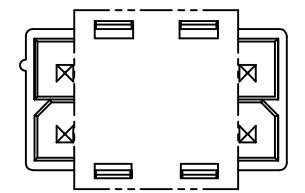

(VIEW WITH CAP)

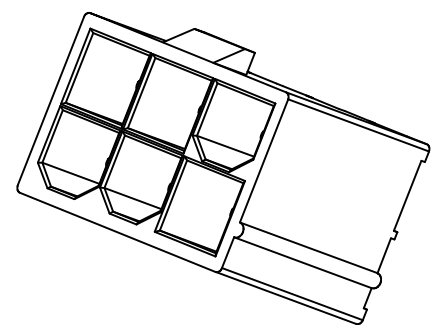

Amphenol
FCI

© 2016 AFCI

mat'l. code		surface ISO 1302 ✓		tolerance ISO 406 ISO 1101		projection mm		product family MinitekPWR 4.2	
ltr	ecn no	dr	date	tolerances unless otherwise specified		mm		title MINITEK PWR4.2,WTB STANDARD HEADER, DUAL ROW,VT,DIP TYPE	
				angles	linear	mm		dwg no 10127820	
				0°±1°		scaleN.T.S		sheet 2 of 3 size A3	
				dr	TAI	2013-11-11		type Product Customer Drawing	
				enr	SONY	2023-01-09			
				chr	SONY	2023-01-09			
				appd	MITHUN	2023-01-09			
sheet index	revision sheet	R 1	R 2	R 3					

1

2 3

4

5

6

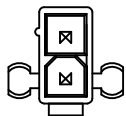

2 POS

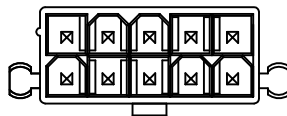

10 POS

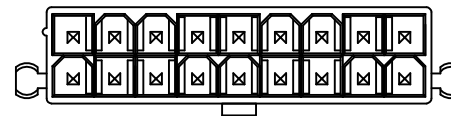

18 POS

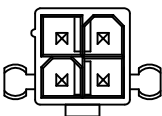

4 POS

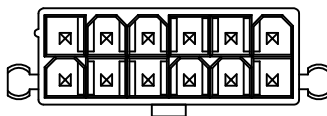

12 POS

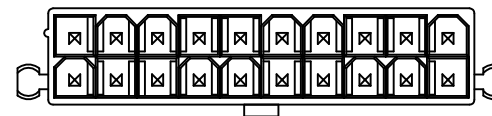

20 POS

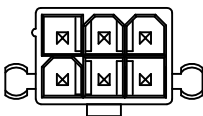

6 POS

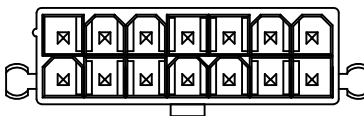

14 POS

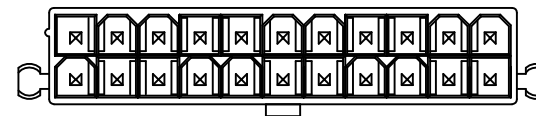

22 POS

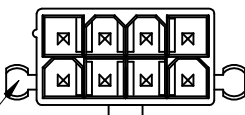

8 POS

WITH PEG

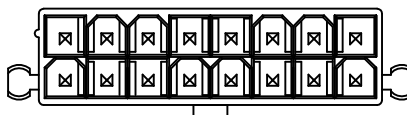

16 POS

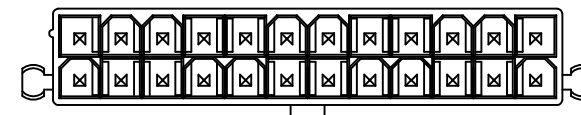

24 POS

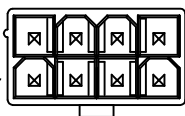

VIEW WITHOUT PEG

NO PEG

Amphenol FCI

© 2016 AFCI

mat'l. code		surface ISO 1302 ✓		tolerance ISO 406 ISO 1101		projection 		product family MinitekPWR 4.2	
ltr	ecn no	dr	date	tolerances unless otherwise specified		mm 		title MINITEK PWR4.2,WTB STANDARD HEADER, DUAL ROW,VT,DIP TYPE	
				angles	linear	mm		dwg no	
				0°±1'		scaleN.T.S		sheet 3 of 3 size	
				dr	TAI	2013-11-11		A3	
				enr	SONY	2023-01-09		10127820	
				chr	SONY	2023-01-09		type Product Customer Drawing	
				appd	MITHUN	2023-01-09			
sheet index	revision sheet	R	R	R					
		1	2	3					