

PROTECTION PRODUCTS - MicroClamp®

Description

The μClamp®3601P is a high-surge transient voltage suppressor (TVS) optimized for protection of sensitive digital sensors used in proximity switches and industrial control applications. The μClamp3601P protects the components from over-voltages caused by **Electro-Static Discharge (ESD)**, **Electrical Fast Transients (EFT)**, and **Tertiary Lightning**.

The μClamp3601P features a working voltage of 33 volts with a minimum breakdown voltage of 34 volts. They are rated to handle a continuous forward current of up to 260mA with a low forward voltage drop of less than 1 volt ($I_F = 200\text{mA}$). They are designed with high surge capability (2 Amps at $t_p = 1.2/50\mu\text{s}$) and a low clamping voltage of <60V.

The μClamp3601P is in an 2-pin SLP1006P2 package. It measures 1.0 x 0.6 x 0.5mm. The leads are spaced at a pitch of 0.65mm and are finished with lead-free NiPdAu. Each device will protect one line operating at 33 volts. The small size and unique features of the μClamp3601P make it ideal for protection of DC high-side proximity switches in industrial and automotive applications.

The μClamp3601P is qualified to AEC-Q100 Grade1.

Features

- ◆ Transient protection for data and power lines to **IEC 61000-4-2 (ESD) ±20kV (air), ±15kV (contact)**
- ◆ **IEC 61000-4-4 (EFT) 40A (5/50ns)**
- ◆ **IEC 61000-4-5 (Lightning) 2A (1.2/50μs)**
- ◆ Ultra-small package
- ◆ Bidirectionally protects one data line
- ◆ Low clamping voltage
- ◆ Working voltage: 33V
- ◆ Low leakage current
- ◆ Solid-state silicon-avalanche technology
- ◆ Qualified to AEC-Q100 Grade1

Mechanical Characteristics

- ◆ SLP1006P2 package
- ◆ Pb-Free, Halogen Free, RoHS/WEEE Compliant
- ◆ Nominal Dimensions: 1.0 x 0.6 x 0.5 mm
- ◆ Lead Finish: NiPdAu
- ◆ Molding compound flammability rating: UL 94V-0
- ◆ Marking: Marking code, cathode band
- ◆ Packaging: Tape and Reel

Applications

- ◆ Two, Three, and Four Wire DC High-Side Proximity Switches
- ◆ Digital Sensor Input Protection
- ◆ Industrial Controls
- ◆ 24V - 33V DC Supply Protection
- ◆ Automotive Applications

Dimensions

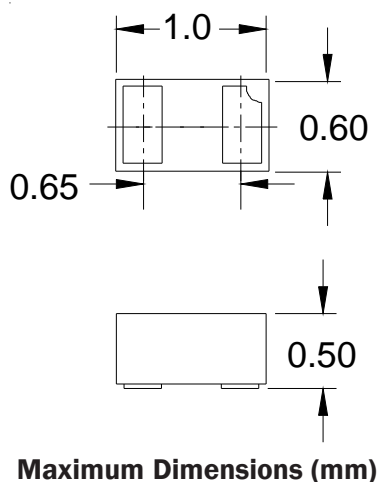

Schematic & Pin Configuration

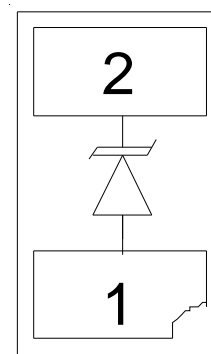

SLP1006P2 (Bottom View)

PROTECTION PRODUCTS
Absolute Maximum Ratings

| Rating | Symbol | Value | Units |
|--|------------|------------------|-------|
| Peak Pulse Power ($t_p = 8/20\mu s$) | P_{pk} | 170 | Watts |
| Peak Pulse Power ($t_p = 1.2/50\mu s$) | P_{pk} | 125 | Watts |
| Peak Pulse Current ($t_p = 1.2/50\mu s$) | I_{pp} | 2 | A |
| ESD per IEC 61000-4-2 (Air) ESD per IEC 61000-4-2 (Contact) | V_{ESD} | +/- 20 +/- 15 | kV |
| Continuous Forward Current | I_{FMAX} | 260 | mA |
| Operating Temperature | T_J | -40 to +125 | °C |
| Storage Temperature | T_{STG} | -55 to +150 | °C |

Electrical Characteristics (T=25°C unless otherwise specified)

| Parameter | Symb-ol | Conditions | Minimum | Typical | Maximum | Units |
|---------------------------|-----------|----------------------------------|--------------------|---------|---------|-------|
| Reverse Stand-Off Voltage | V_{RWM} | | | | 33 | V |
| Reverse Breakdown Voltage | V_{BR} | $I_t = 1mA$ | T=25 °C | 36 | | V |
| | | | T=-40 °C to 125 °C | 34 | | |
| Reverse Leakage Current | I_R | $V_{RWM} = 33V$ | T=25 °C | | 1 | µA |
| | | | T=125 °C | | | |
| Forward Voltage | V_F | $I_F = 200mA$ | | | 1 | V |
| Clamping Voltage | V_C | $I_{pp} = 2A, t_p = 1.2/50\mu s$ | | | 60 | V |
| Junction Capacitance | C_j | $V_R = 0V,$ $f = 1MHz$ | T=25 °C | | 25 | pF |
| | | | T=-40 °C to 125 °C | | | |

PROTECTION PRODUCTS

Typical Characteristics

Non-Repetitive Peak Pulse Power vs. Pulse Time

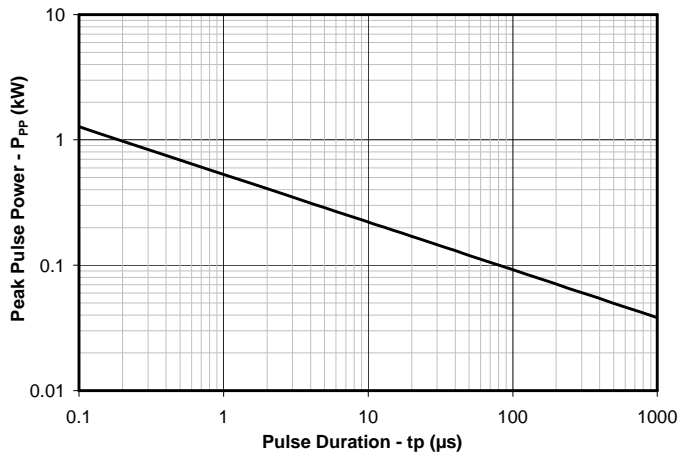

Power Derating Curve

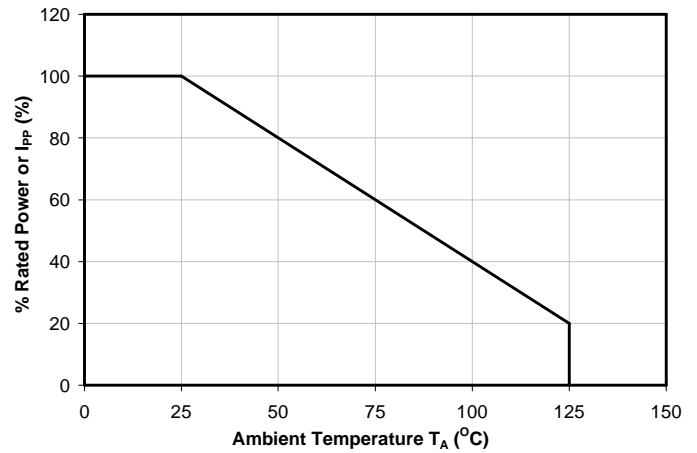

Clamping Voltage vs. Peak Pulse Current

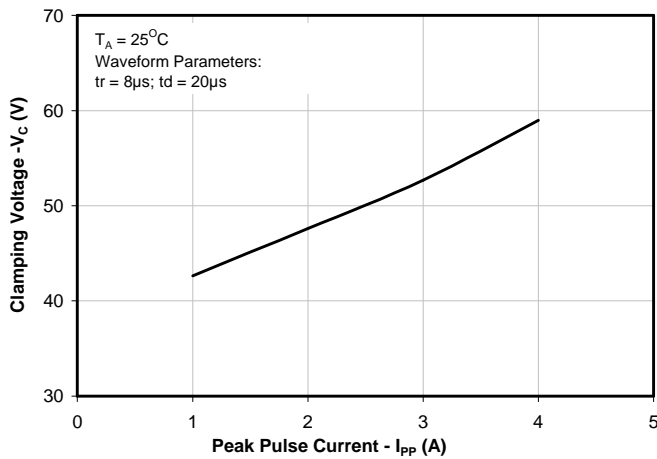

ESD Clamping (8kV Contact per IEC 61000-4-2)

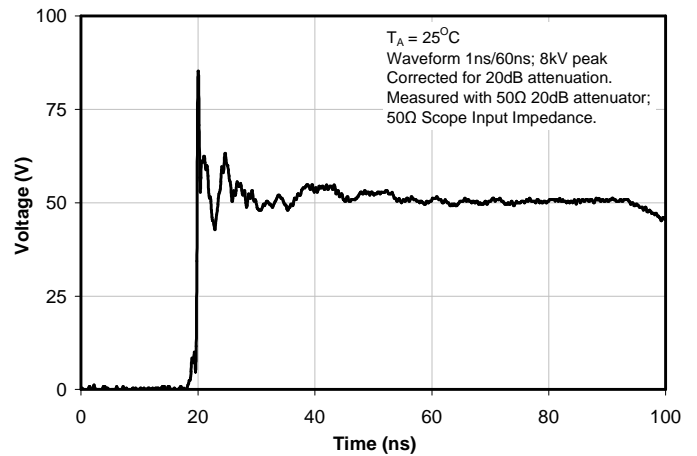

Forward Voltage vs. Forward Current

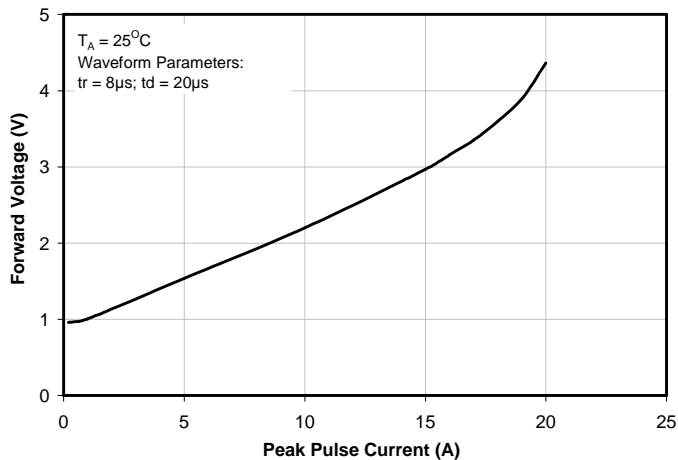

Junction Capacitance vs. Reverse Voltage

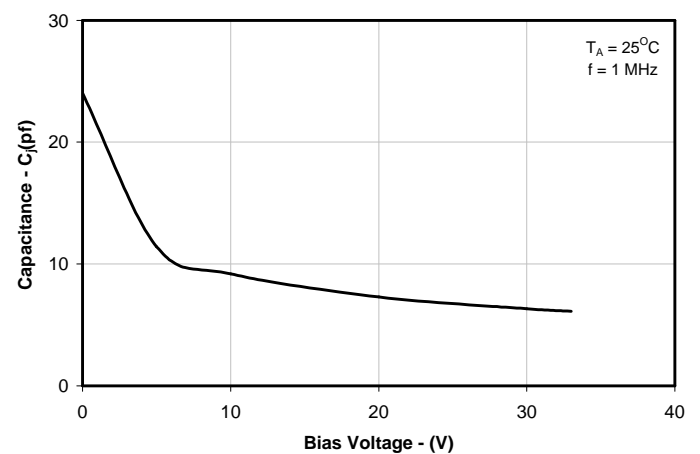

PROTECTION PRODUCTS

Typical Characteristics

Typical Positive Clamping Voltage vs Surge Voltage

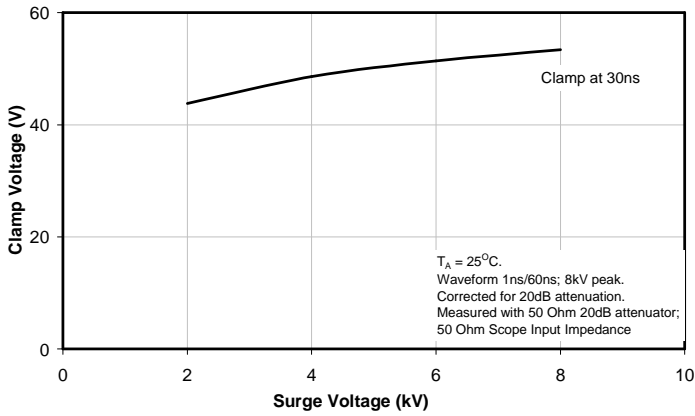

Typical Negative Clamping Voltage vs Surge Voltage

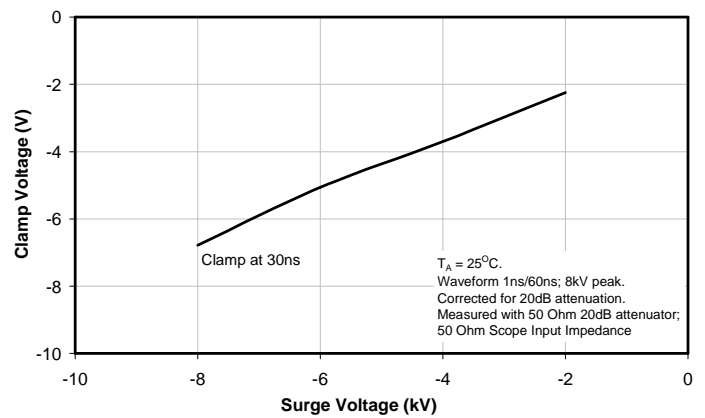

Typical Junction Capacitance vs Temperature

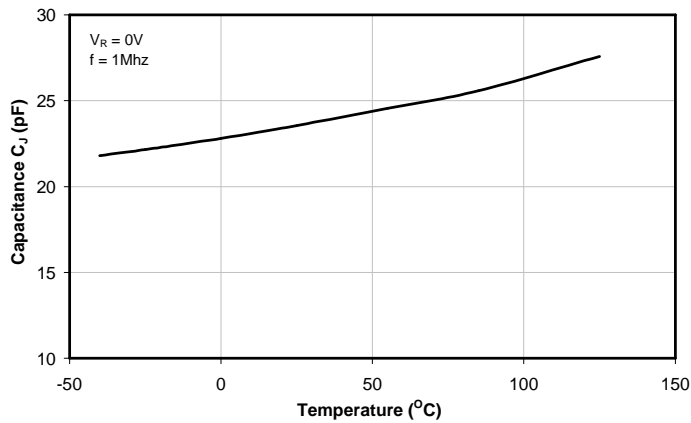

Typical Leakage Current vs Reverse Voltage

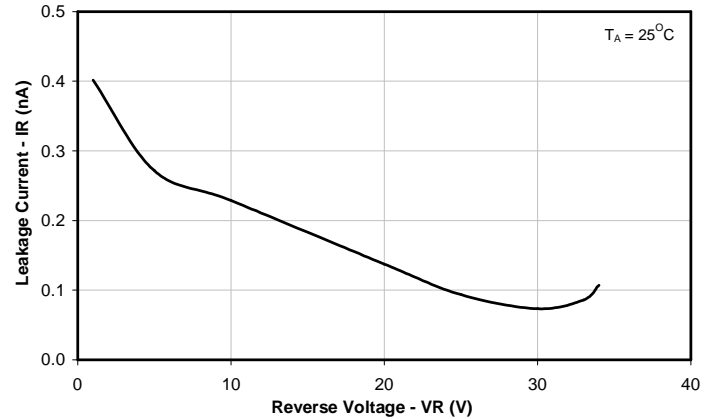

Typical Leakage Current vs Temperature

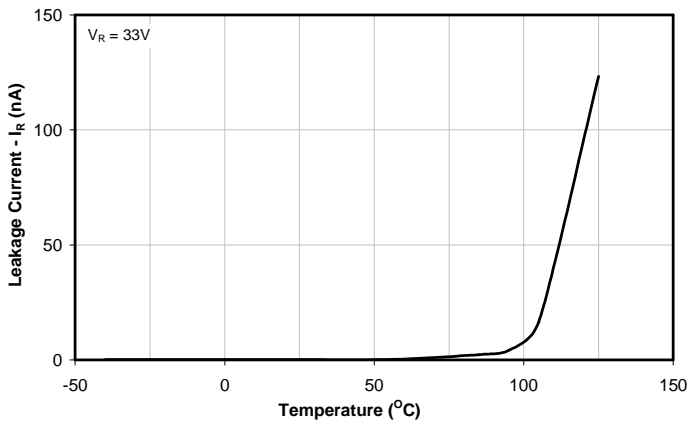

Typical Breakdown Voltage vs Temperature

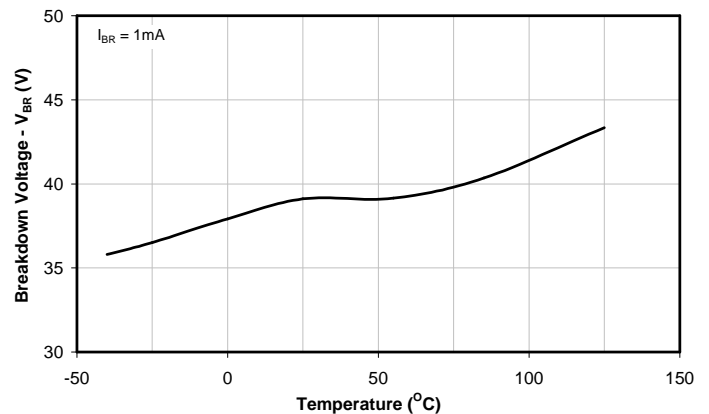

PROTECTION PRODUCTS

Typical Characteristics

Typical Insertion Loss

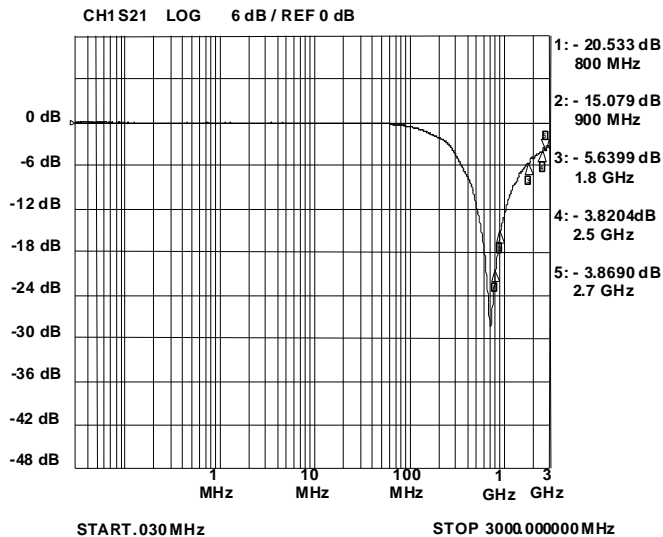

Applications Information

Device Connection for Protection of Two, Three, and Four Wire Proximity Switches

Digital sensors help to bridge the gap between the physical world and the digital world in applications such as computer controlled factory automation. In such environments, transient voltages can easily disrupt or damage sensitive sensor inputs. The μ Clamp3601P provides transient voltage protection for the digital sensors to ESD, lightning, and CDE events.

The μ Clamp3601P is designed to meet the high surge capability and low clamping voltage needed to protect the ASIC and control logic used in proximity switches. The μ Clamp3601P provides protection for the power and I/O lines.

Device Schematic & Pin Configuration

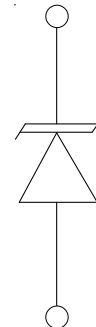

Application Example

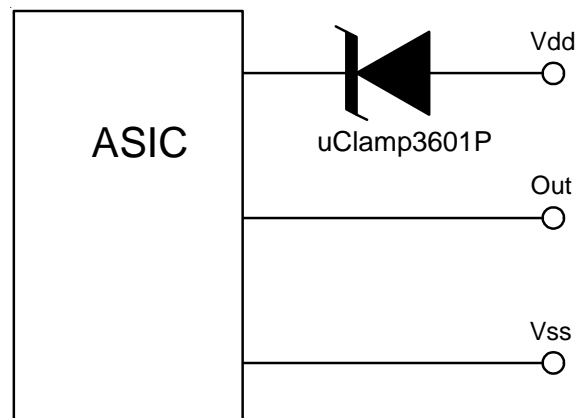

PROTECTION PRODUCTS

Outline Drawing - SLP1006P2

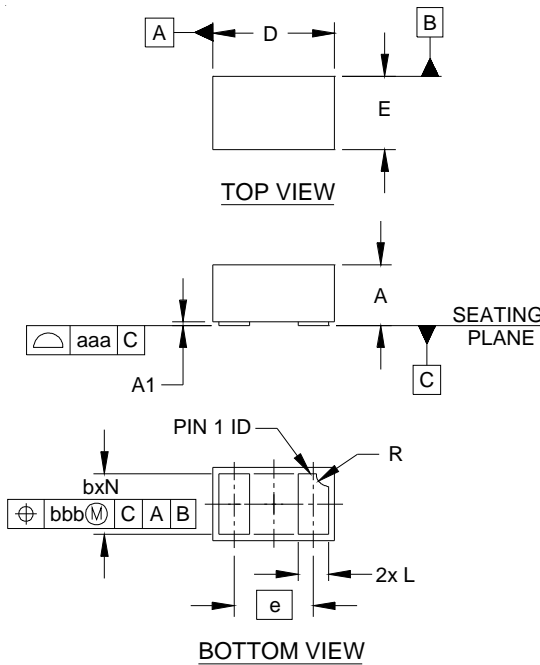

| DIM | INCHES | | MILLIMETERS | | | |
|-----|----------|------|-------------|------|------|------|
| | MIN | NOM | MAX | MIN | NOM | MAX |
| A | .016 | .020 | .022 | 0.40 | 0.50 | 0.55 |
| A1 | .000 | .001 | .002 | 0.00 | 0.03 | 0.05 |
| b | .018 | .020 | .022 | 0.45 | 0.50 | 0.55 |
| D | .035 | .039 | .043 | 0.90 | 1.00 | 1.10 |
| E | .020 | .024 | .028 | 0.50 | 0.60 | 0.70 |
| e | .026 BSC | | 0.65 BSC | | | |
| L | .008 | .010 | .012 | 0.20 | 0.25 | 0.30 |
| R | .002 | .004 | .006 | 0.05 | 0.10 | 0.15 |
| N | 2 | | 2 | | | |
| aaa | .003 | | 0.08 | | | |
| bbb | .004 | | 0.10 | | | |

NOTES:

1. CONTROLLING DIMENSIONS ARE IN MILLIMETERS (ANGLES IN DEGREES).

Land Pattern - SLP1006P2

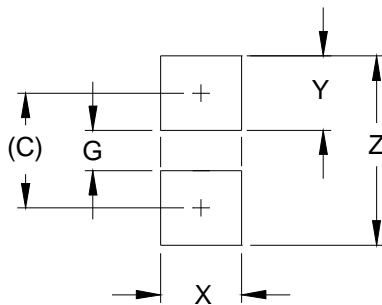

| DIM | DIMENSIONS | |
|-----|------------|-------------|
| | INCHES | MILLIMETERS |
| C | (.033) | (0.85) |
| G | .012 | 0.30 |
| X | .024 | 0.60 |
| Y | .022 | 0.55 |
| Z | .055 | 1.40 |

NOTES:

1. CONTROLLING DIMENSIONS ARE IN MILLIMETERS (ANGLES IN DEGREES).
2. THIS LAND PATTERN IS FOR REFERENCE PURPOSES ONLY. CONSULT YOUR MANUFACTURING GROUP TO ENSURE YOUR COMPANY'S MANUFACTURING GUIDELINES ARE MET.

PROTECTION PRODUCTS

Marking

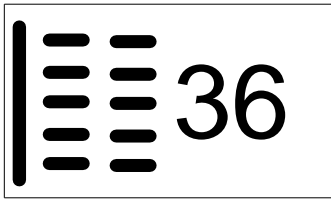

Notes:

1) Marking will also include line matrix date code

Ordering Information

| Part Number | Qty per Reel | Reel Size |
|-----------------|--------------|-----------|
| uClamp3601P.TNT | 10,000 | 7 Inch |

Notes:

1) MicroClamp, uClamp and μ Clamp are trademarks of Semtech Corporation

Tape and Reel Specification

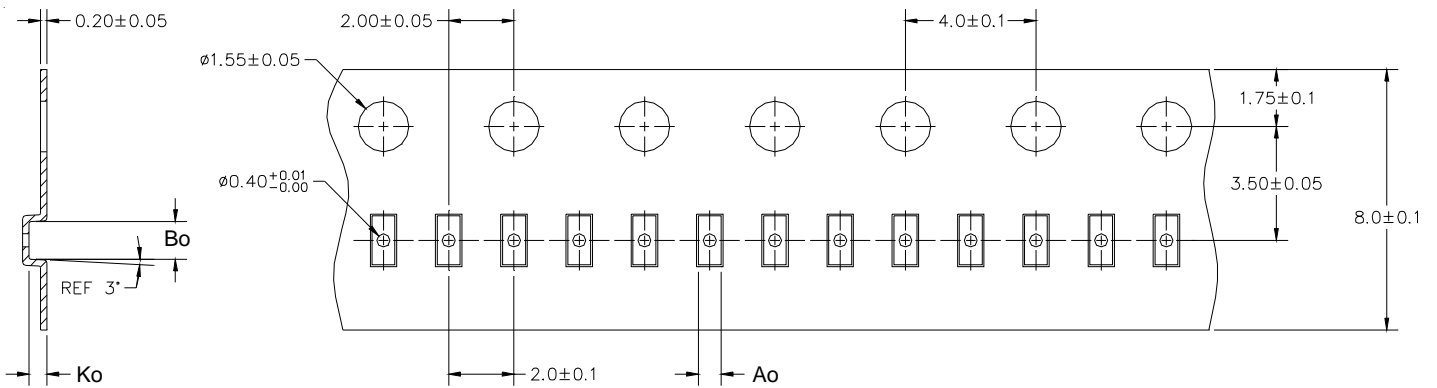

| A0 | B0 | K0 |
|-----------------|-----------------|-----------------|
| 0.69 +/-0.10 mm | 1.19 +/-0.10 mm | 0.66 +/-0.10 mm |

Note: All dimensions in mm unless otherwise specified

Device Orientation in Tape

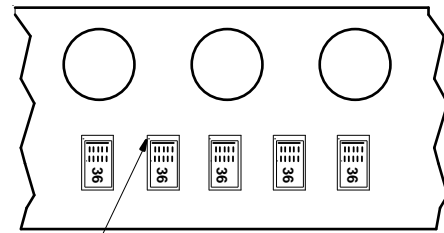

Cathode Band Location
(Towards Sprocket Holes)

Contact Information

Semtech Corporation
 Protection Products Division
 200 Flynn Rd., Camarillo, CA 93012
 Phone: (805)498-2111 FAX (805)498-3804

Mouser Electronics

Authorized Distributor

Click to View Pricing, Inventory, Delivery & Lifecycle Information:

[Semtech:](#)

[UCLAMP3601P.TNT](#)