

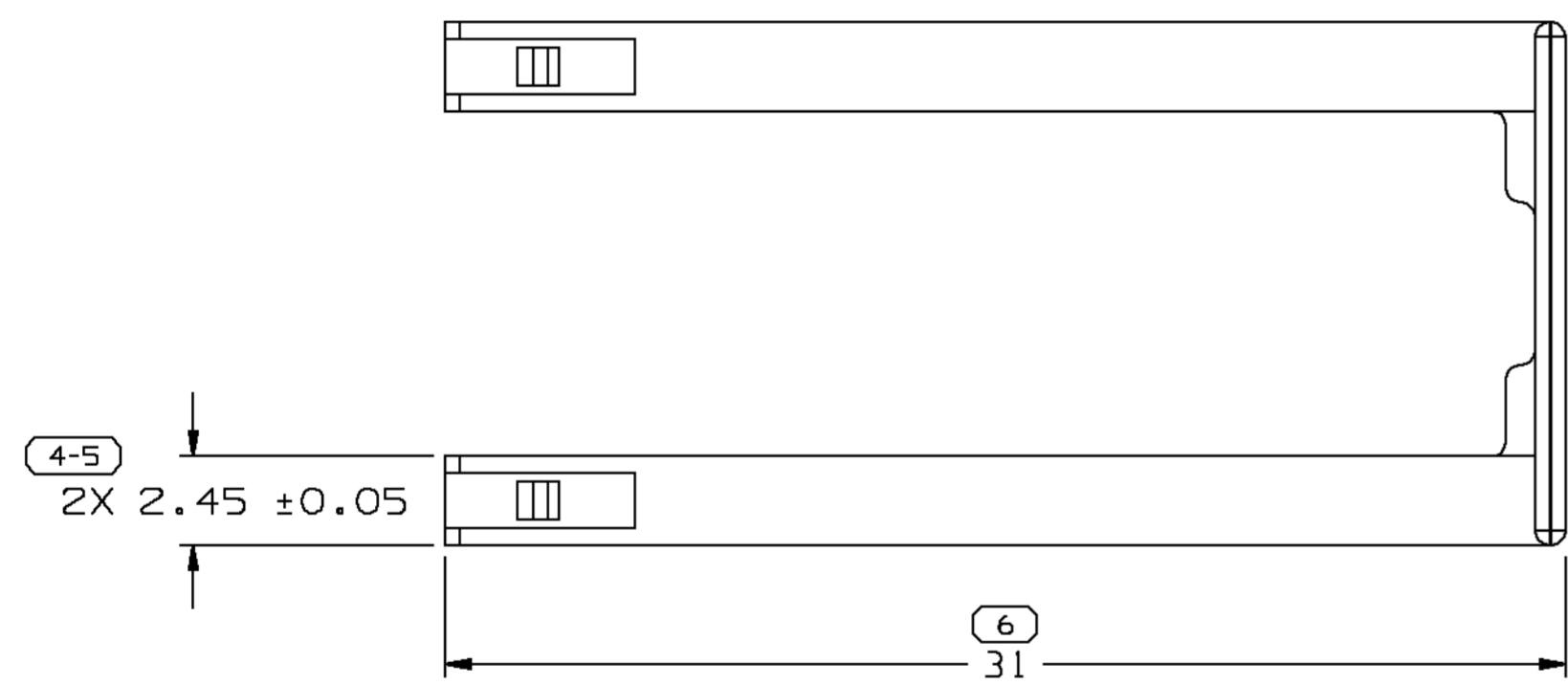

DELPHI PACKARD ELECTRIC SYSTEMS
WARREN, OHIO 44486

SYMBOL DEFINITION		MISSING NUMBERS	
THE NUMBER INSIDE THE SYMBOL  CORRESPONDS TO THE NUMBER ON THE INSPECTION REPORT FOR THIS DRAWING/PART NUMBER	TOTAL NO. OF SYMBOLS ON DRAWING 6		
	LAST NO. USED 8		

DWG STATUS					ZONE	REVISION HISTORY				AUTH	DR	CK	APVD
DATE	STG	REV	CHG	N/P		WAS PE060886, RELEASED				000005	JMR	JMR	DE
11DE00	R	001	-	-									

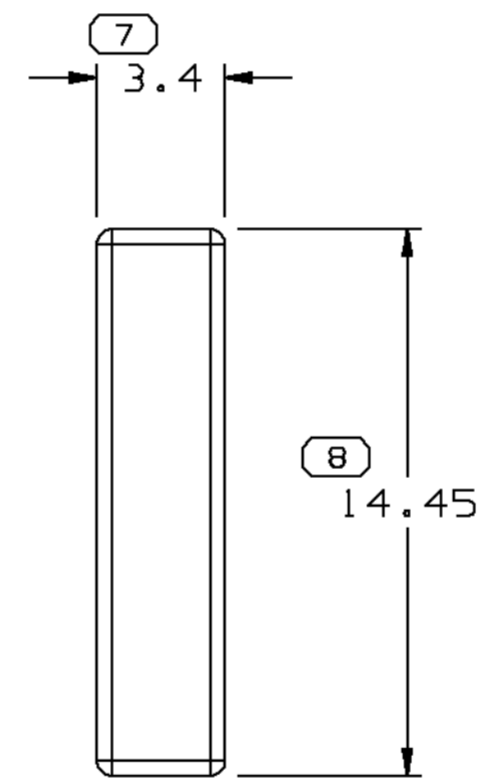
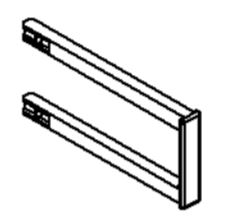
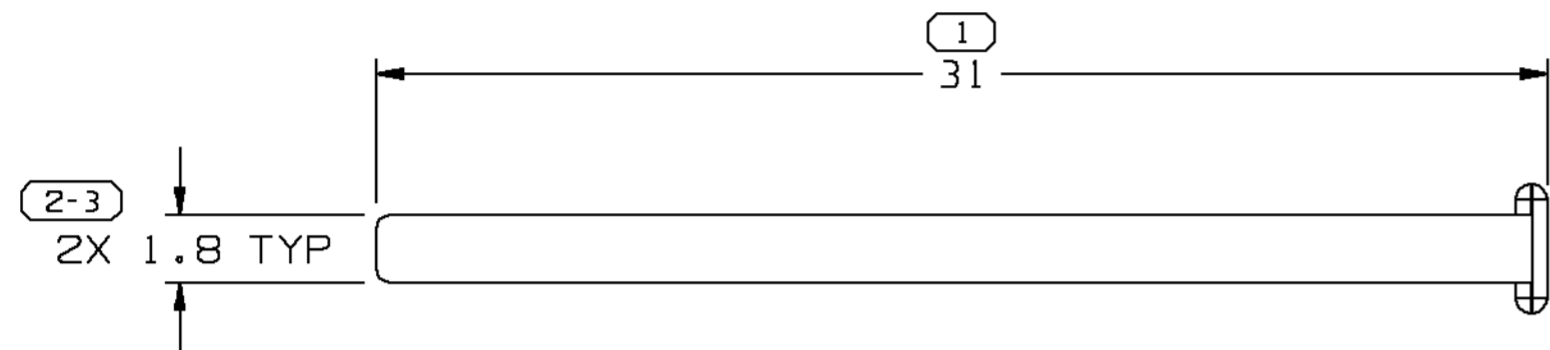

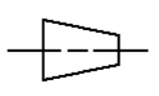
DELPHI Automotive Systems				
MATERIAL SPEC R0100110 PBT-RED				
SUBSTANCES OF CONCERN AND RECYCLED CONTENT PER DELPHI-A 01949001				
PART DRAWING				DISTR CODE D
CODE NUMBER 6900	DWG DATE 11DE00	SCALE 5:1		
QC SPEC	STYLE GMT 360	VOLUME cm ³ .294		
PART GEOMETRY 3D SOLID	UNLESS OTHERWISE SPECIFIED: THIS DOCUMENT IS IN ACCORDANCE WITH ASME Y14.5M - 1994 AS AMENDED BY THE GM GLOBAL DIMENSIONING AND TOLERANCING ADDENDUM - 1997. ALL GEOMETRIC TOLERANCES AND RELATED DATUMS APPLY RFS. RULE #1 (PERFECT FORM AT MMC) DOES NOT APPLY WHEN RELATIONSHIP BETWEEN FEATURES IS ESTABLISHED BY ORIENTATION OR LOCATION TOLERANCES. SEPARATE POSITION CALLOUTS MAY BE GAGED SEPARATELY REGARDLESS OF DATUM REFERENCES.			
 CHANGE RESTRICTED NO MANUAL CHANGES	COPY OF MATH DATA DO NOT SCALE		REFERENCE 001,701	DATE
METRIC UNLESS OTHERWISE SPECIFIED, ALL DIMENSIONS ARE IN MILLIMETERS			DR	
			APVD1 J. RICHARDSON	11DE00
			APVD2 J. RICHARDSON	11DE00
			APVD3 D. EICHORN	13DE00
			APVD4	
			APVD5	
THIRD ANGLE PROJECTION 	DRAWING NAME TPA 32F MIC/P 100W			
SHEET NUMBER 1 OF 1	DRAWING NUMBER 15404650		DWG STATUS STG REV N/P R 001 -	
			SIZE A2	

- NOTES
- UNLESS OTHERWISE SPECIFIED AND/OR INDICATED: DIMENSIONS ARE TO FACE OF VIEW SHOWN AND AUTOMATICALLY ROUNDED BY COMPUTER FOR INSPECTION. (SEE MATH MODEL FOR PRECISE DIMENSIONS.) FOR ALL OTHER DIMENSIONS NOT SHOWN BUT REQUIRED FOR TOOL BUILD, SEE MATH MODEL FOR PRECISE TOOL PATH DATA.
 - MATING COMPONENTS OR EQUIVALENT:
CONNECTOR 15401560
HOUSING TAXI 15354779
(2 PARTS NEEDED PER HOUSING CONN)

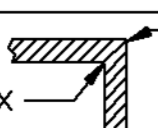
 R 0.2 MAX SHARP CORNER TOLERANCE	DIMENSIONAL RANGE (MM) CHART E1									
	FROM TO	0 20	> 20 30	> 30 70	> 70 100	> 100 150	> 150 200	> 200 250	> 250 300	> 300 400
	TOLERANCE UNLESS OTHERWISE SPECIFIED									
		±0.15	±0.2	±0.3	±0.4	±0.5	±0.6	±0.8	±1	±1.2
ANGULAR TOLERANCE ± 2°										

8 7 6 5 4 3 2 1

F

E

D

C

B

A

8 7 6 5 4 3 2 1

Mouser Electronics

Authorized Distributor

Click to View Pricing, Inventory, Delivery & Lifecycle Information:

[Aptiv:](#)

[15404650](#)