

Ceramic Chip Capacitors

Type NPO, X5R, X7R, Y5V

ISO 9001:2008
CERTIFIED
TS-16949
CERTIFIED

1. General

1-1 Range of Application

This document applies to miniaturized ceramic chip capacitors for applications in circuits of electronic devices.

2. Type Designation

The type designation shall be the following form:

New Type

NPO	0805	H	T	TD	101	K
Dielectric	Size	Voltage	Termination Material	Packaging	Capacitance Code	Tolerance
NPO X5R X7R Y5V	0402 0603 0805 1206 1210	A = 10V C = 16V E = 25V H = 50V I = 100V J = 200V K = 6.3V	T: Sn	TP: 7" 2mm pitch (0402 only) TD: 7" paper tape TE: 7" embossed plastic TDB: 13" paper tape TEB: 13" embossed plastic	NPO, X5R, X7R, Y5V - 2 significant digits + no. of zeros. R indicates decimal point.	B = ±0.1pF C = ±0.25pF D = ±0.5pF F = ±1% G = ±2% J = ±5% K = ±10% M = ±20% Z = +80%, -20%

3. Dimensions and Construction

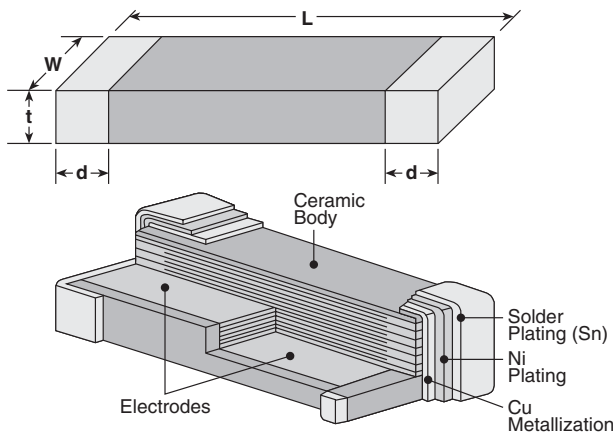

Case Size	Dimensions inches (mm)			
	L	W	t (Max.)	d
0402	.039±.004 (1.0±0.1)	.02±.004 (0.5±0.1)	.021 (0.55)	.01±.006 (0.25±0.15)
0603	.063±.006 (1.6±0.15)	.032±.006 (0.81±0.15)	.035 (0.9)	.014±.006 (0.35±0.15)
0805	.079±.008 (2.01±0.2)	.049±.008 (1.25±0.2)	.051 (1.3)	.02±.01 (0.50±0.25)
1206	.126±.008 (3.2±0.2)	.063±.008 (1.6±0.2)	.059 (1.5)	.02±.01 (0.5±0.25)
1210	.126±.008 (3.2±0.2)	.098±.008 (2.5±0.2)	.067 (1.7)	.02±.01 (0.5±0.25)

4. Terminations

- Standard Nickel Barrier
- Solder Plated

5. Applications and Ratings

Dielectric	Capacitance Tolerance	Voltage Ratings	Dissipation Factor	T.C.C.	Test Voltage	Operating Temperature	Insulation Resistance
NPO	.47pF~8.2pF= C:±0.25pF 5.6pF~8.2pF= D±0.5pF 10pF~ 10000pF= F:±1%, G:±2%,J:±5%	50V 100V 200V	For Values >30pF: 0.1% max., ≤30pF: Q = 400 + 20 x C DF = 1/Q C is in pF	0 ± 30 ppm/°C	1.0 ± 0.2 Vrms	-55°C to +125°C	+25°C 100,000MΩ min. or 1000 MΩ - μF min. whichever is less
X5R	K: ±10%	6.3V 10V	6.3V = 7.5% max. 10V = 10% max.	±15% (0 VDC)	1.0 ± 0.2 Vrms	-55°C to +85°C	+25°C 100,000MΩ min. or 500 MΩ - μF min. whichever is less
X7R	K: ±10%	10V 16V 25V 50V 100V 200V	10V = 10% max. 16V = 3.5% max. 25V, 50V, 100V = 2.5% max.	±15% (0 VDC)	1.0 ± 0.2 Vrms	-55°C to +125°C	+25°C 100,000MΩ min. or 1000 MΩ - μF min. whichever is less
Y5V	Z: +80, -20%	10V 16V 25V 50V	16V & 25V = 7.0% 50V = 5.0%	+22% to -82% max.	1.0 ± 0.2 Vrms	-30°C to +85°C	+25°C 10,000MΩ min. or 1000 MΩ - μF min. whichever is less

For complete environmental specifications, please refer to www.koaspeer.com

6. NPO Capacitance Voltage Availability

Size			0402*	0603*		0805			1206		
pF	Capacitance μF	Cap. Code	50 (H)	50 (H)	100 (I)	50 (H)	100 (I)	200 (J)	50 (H)	100 (I)	200 (J)
0.47	.00000047	R47									
0.56	.00000056	R56									
0.68	.00000068	R68									
0.82	.00000082	R82									
1	.0000010	1R0									
1.2	.0000012	1R2									
1.5	.0000015	1R5									
1.8	.0000018	1R8									
2.2	.0000022	2R2									
2.7	.0000027	2R7									
3.3	.0000033	3R3									
3.9	.0000039	3R9									
4.7	.0000047	4R7									
5.6	.0000056	5R6									
6.8	.0000068	6R8									
8.2	.0000082	8R2									
10	.000010	100									
12	.000012	120									
15	.000015	150									
18	.000018	180									
22	.000022	220									
27	.000027	270									
33	.000033	330									
39	.000039	390									
47	.000047	470									
56	.000056	560									
68	.000068	680									
82	.000082	820									
100	.0001	101									
120	.00012	121									
150	.00015	151									
180	.00018	181									
220	.00022	221									
270	.00027	271									
330	.00033	331									
390	.00039	391									
470	.00047	471									
560	.00056	561									
680	.00068	681									
820	.00082	821									
1000	.0010	102									
1200	.0012	122									

Capacitance tolerance available:

.47pF~8.2pF = C: ±0.25pF

5.6pF~8.2pF = D: ±0.5pF

10pF~10000pF = F: ±1%, G: ±2%, J: ±5%

7. X5R Capacitance Voltage Availability

Size			0402	0603		0805	1206	1210
Capacitance values pF	μF	Cap. Code	10 (A)	6.3 (K)	10 (A)	6.3 (K)	10 (A)	10 (A)
			56000	0.056	563			
68000	0.068	683						
82000	0.082	823						
100000	0.10	104						
120000	0.12	124						
150000	0.15	154						
180000	0.18	184						
220000	0.22	224						
270000	0.27	274						
330000	0.33	334						
470000	0.47	474						
560000	0.56	564						
680000	0.68	684						
820000	0.82	824						
1000000	1.0	105						
1200000	1.2	125						
1500000	1.5	155						
1800000	1.8	185						
2200000	2.2	225						
3300000	3.3	335						
4700000	4.7	475						
6800000	6.8	685						
10000000	10	106						
22000000	22	226						
47000000	47	476						
100000000	100	107						

Capacitance tolerance available: ±10%

8. X7R Capacitance Voltage Availability

Size			0402				0603				0805				1206					1210					
Capacitance values pF	μF	Cap. Code	10	16	25	50	10	16	25	50	10	16	25	50	100	200	10	16	50	100	200	50	100	200	
			(A)	(C)	(E)	(H)	(A)	(C)	(E)	(H)	(A)	(C)	(E)	(H)	(I)	(J)	(A)	(C)	(H)	(I)	(J)	(H)	(I)	(J)	
100	.0001	101																							
120	.00012	121																							
150	.00015	151																							
180	.00018	181																							
220	.00022	221																							
270	.00027	271																							
330	.00033	331																							
390	.00039	391																							
470	.00047	471																							
560	.00056	561																							
680	.00068	681																							
820	.00082	821																							
1000	.0010	102																							
1200	.0012	122																							
1500	.0015	152																							
1800	.0018	182																							
2200	.0022	222																							
2700	.0027	272																							
3300	.0033	332																							
3900	.0039	392																							
4700	.0047	472																							
5600	.0056	562																							
6800	.0068	682																							
8200	.0082	822																							
10000	.010	103																							
12000	.012	123																							
15000	.015	153																							
18000	.018	183																							
22000	.022	223																							
27000	.027	273																							
33000	.033	333																							
39000	.039	393																							
47000	.047	473																							
56000	.056	563																							
68000	.068	683																							
82000	.082	823																							
100000	.100	104																							
120000	.120	124																							
150000	.150	154																							
180000	.180	184																							
220000	.220	224																							
270000	.270	274																							
330000	.330	334																							
390000	.390	394																							
470000	.470	474																							
560000	.560	564																							
680000	.680	684																							
1000000	1.00	105																							
1200000	1.20	125																							
1500000	1.50	155																							
1800000	1.80	185																							
2200000	2.20	225																							
3900000	3.90	395																							
4700000	4.70	475																							

Capacitance tolerance available: ±10%

9. Y5V Capacitance Voltage Availability

Size			0402	0603				0805				1206			
Capacitance values			16	16	25	50	10	16	25	50	10	16	25	50	
pF	μF	Cap. Code	(C)	(C)	(E)	(H)	(A)	(C)	(E)	(H)	(A)	(C)	(E)	(H)	
2200	.0022	222													
2700	.0027	272													
3300	.0033	332													
3900	.0039	392													
4700	.0047	472													
5600	.0056	562													
6800	.0068	682													
8200	.0082	822													
10000	.010	103	█		█	█			█	█					
12000	.012	123													
15000	.015	153	█		█					█					
18000	.018	183													
22000	.022	223	█		█	█				█	█				
27000	.027	273													
33000	.033	333	█		█	█									
39000	.039	393													
47000	.047	473	█		█	█				█	█				
56000	.056	563													
68000	.068	683	█		█	█				█	█				
82000	.082	823													
100000	.100	104	█	█	█	█				█	█		█	█	
120000	.120	124													
150000	.150	154		█						█					
180000	.180	184													
220000	.220	224		█						█	█		█	█	
270000	.270	274													
330000	.330	334		█									█	█	
390000	.390	394													
470000	.470	474		█					█				█	█	
560000	.560	564													
680000	.680	684											█	█	
820000	.820	824											█		
1000000	1.0	105							█			█			
1200000	1.2	125													
1500000	1.5	155													
1800000	1.8	185													
2200000	2.2	225											█		
2700000	2.7	275													
3300000	3.3	335										█			
3900000	3.9	395													
4700000	4.7	475						█				█			
5600000	5.6	565													
6800000	6.8	685													
10000000	10	106						█							
22000000	22	226										█			

Capacitance tolerance available: +80%, -20%

10. Typical Impedance Characteristics - NPO

Variation of Impedance with Cap Value
Impedance vs. Frequency
0805 - C0G (NPO)
10 pF vs. 100 pF vs. 1000 pF

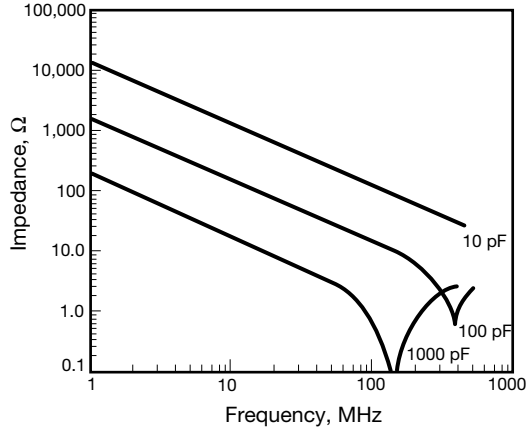

Δ Capacitance vs. Frequency

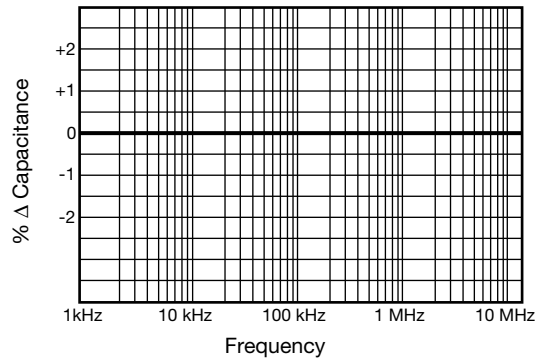

Temperature Coefficient

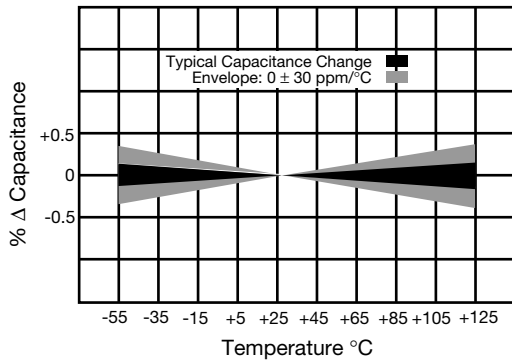

Insulation Resistance vs. Temperature

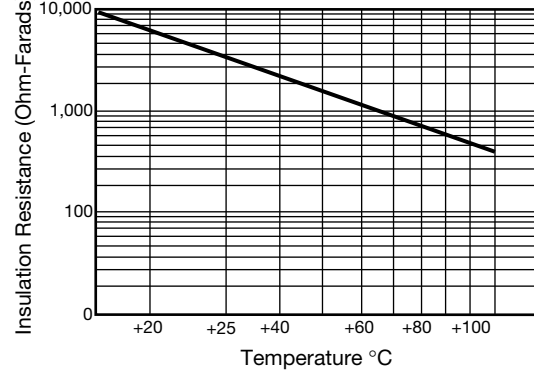

Variation of Impedance with Chip Size
Impedance vs. Frequency
1000 pF - C0G (NPO)

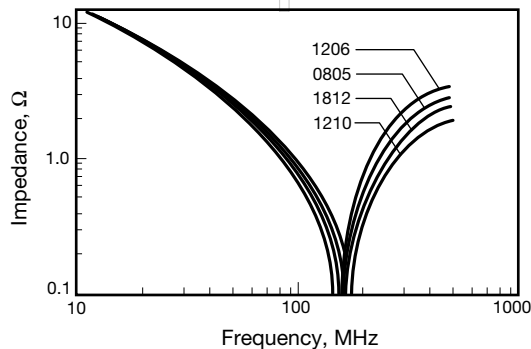

Variation of Impedance with Ceramic Formulation
Impedance vs. Frequency
1000 pF - C0G (NPO) vs X7R
0805

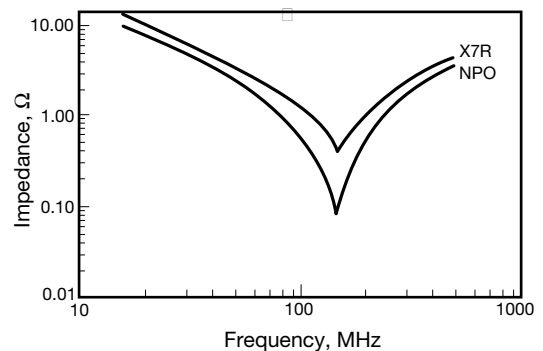

11. Typical Impedance Characteristics - X5R

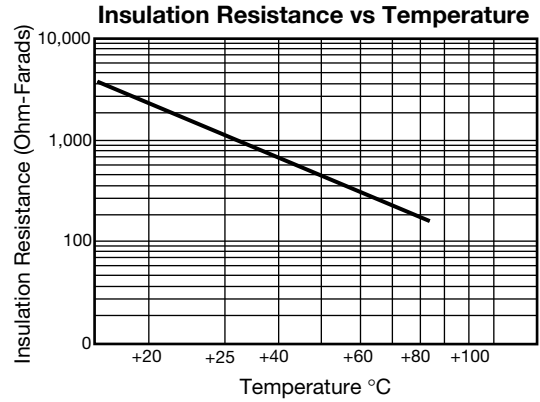
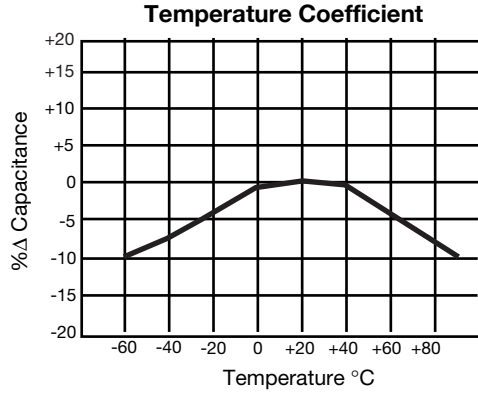

12. Typical Impedance Characteristics - X7R

Variation of Impedance with Cap Value
Impedance vs. Frequency
1,000 pF vs. 10,000 pF - X7R
0805

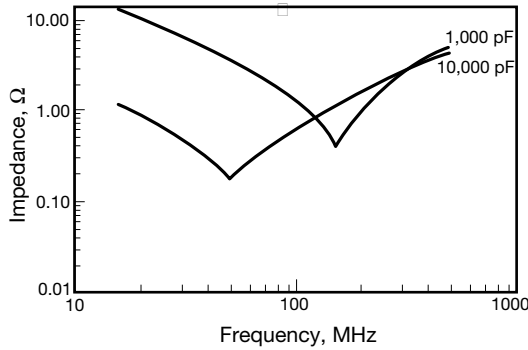

Δ Capacitance vs. Frequency

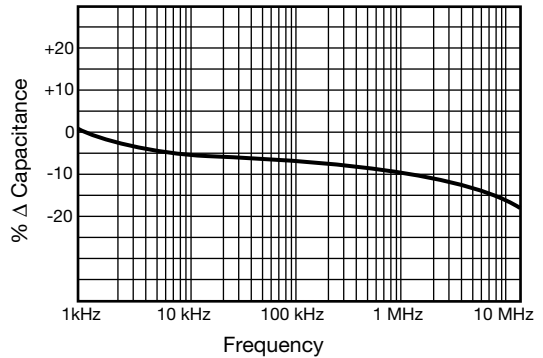

Temperature Coefficient

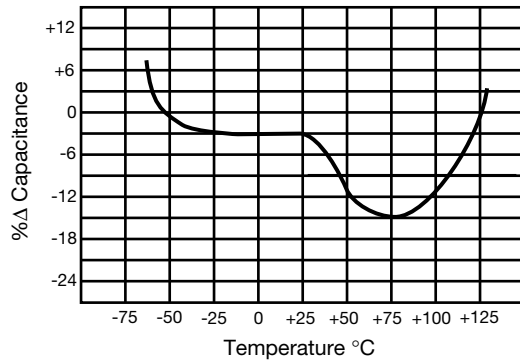

Insulation Resistance vs Temperature

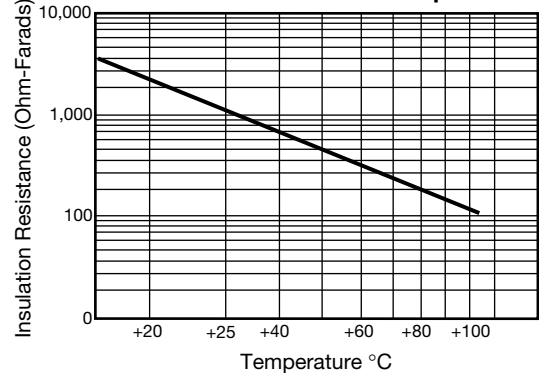

Variation of Impedance with Chip Size
Impedance vs. Frequency
10,000 pF - X7R

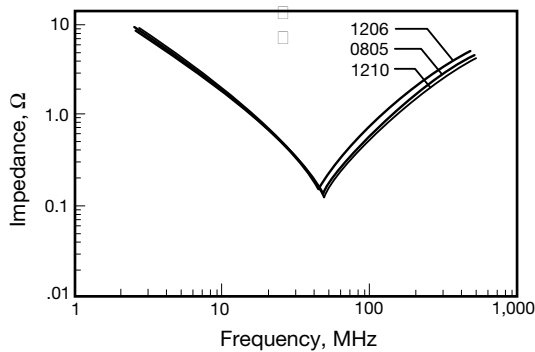

Variation of Impedance with Chip Size
Impedance vs. Frequency
100,000 pF - X7R

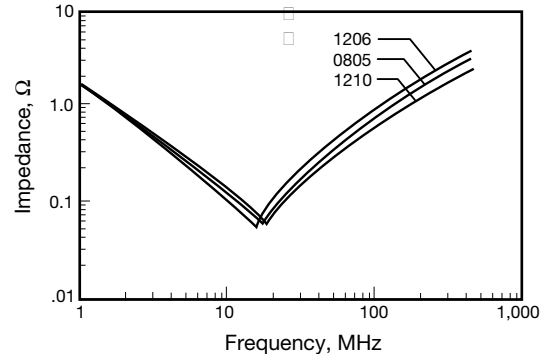

13. Typical Impedance Characteristics - Y5V

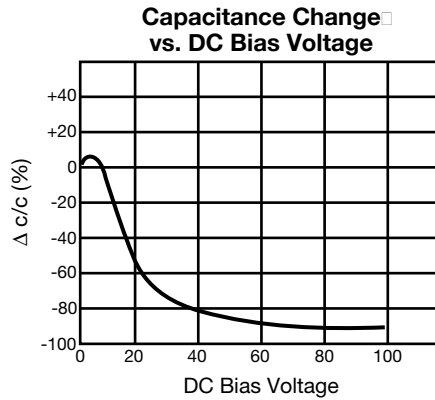
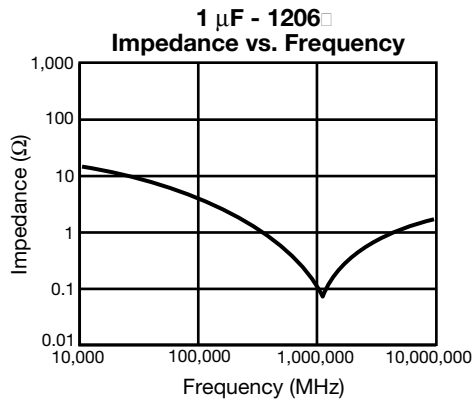
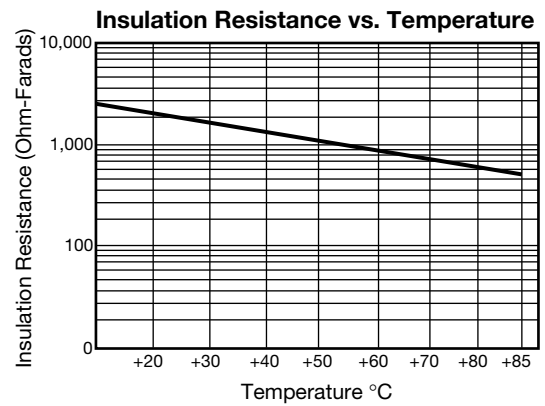
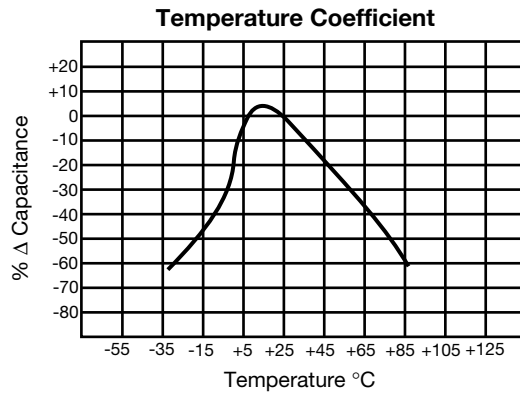
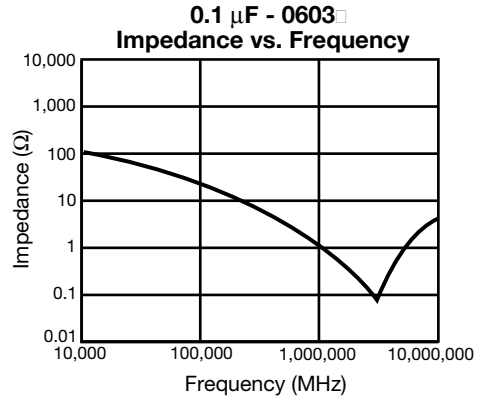
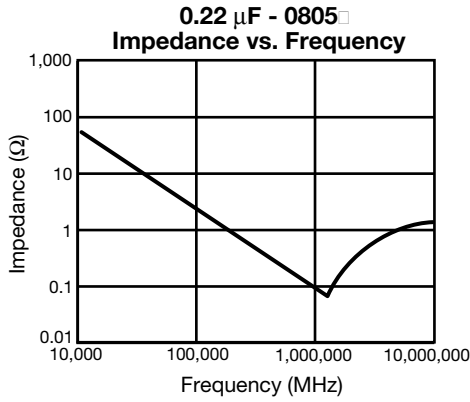

14. Tape and Reel Quantities

All tape and reel specifications are in compliance with RS481.

Size	Dielectric	Voltage	Cap. Range	TP	TD	TE	TDB	TEB	
0402	All	All	All	10000	—	—	—	—	
0603	All	All	All	—	4000	—	15000	—	
0805	NPO	All	All	—	4000	—	20000	—	
	X5R	All	All	—	—	3000	—	—	
	X7R	200	472	—	4000	—	15000	—	—
		200	682	—	—	3000	—	10000	—
		100	< = 103	—	4000	—	20000	—	—
		100	153 ~ 223	—	4000	—	15000	—	—
		50	< = 223	—	4000	—	20000	—	—
		50	273 ~ 563	—	4000	—	15000	—	—
		50	104	—	4000	—	15000	—	—
		25	< = 333	—	4000	—	20000	—	—
		25	393 ~ 104	—	4000	—	15000	—	—
		16	473 ~ 683	—	4000	—	20000	—	—
	16	823 ~ 274	—	4000	—	15000	—	—	
	16	334 ~ 474	—	—	3000	—	10000	—	
	10	684 ~ 105	—	—	3000	—	10000	—	
	Y5V	50	103 ~ 104	—	4000	—	20000	—	—
		50	224	—	4000	—	15000	—	—
		25	103 ~ 104	—	4000	—	20000	—	—
		25	154 ~ 224	—	4000	—	15000	—	—
		16	474, 105	—	4000	—	15000	—	—
10		All	—	—	3000	—	10000	—	

* TP is a 7" reel with a 2mm pitch, TD & TE are 7" reels, TDB & TEB are 13" reels

Size	Dielectric	Voltage	Cap. Range	TD	TE	TDB	TEB
1206	NPO	200	< = 151	4000	—	20000	—
		200	221 ~ 102	4000	—	15000	—
		100	< = 471	4000	—	20000	—
		50	< = 471	4000	—	20000	—
	X5R	10	475, 106	—	3000	—	—
		100	< = 473	4000	—	15000	—
		100	683	—	4000	—	—
		100	104	—	2000	—	—
		200	< = 153	4000	—	15000	—
		200	223	—	3000	—	10000
		50	< = 124	4000	—	15000	—
		50	154 ~ 224	—	3000	—	10000
		16	< = 394	4000	—	15000	—
		16	474 ~ 105	—	3000	—	10000
	X7R	10	225 ~ 275	—	3000	—	10000
		50	104 ~ 224	4000	—	20000	—
		50	334 ~ 474	4000	—	15000	—
		50	684	—	3000	—	10000
		25	104 ~ 224	4000	—	20000	—
		25	334 ~ 684	4000	—	15000	—
25		225	—	3000	—	10000	
16		105	4000	—	15000	—	
10		335 ~ 475	—	3000	—	10000	
10		226	—	2500	—	7000	
1210	X5R	10	106	—	2000	—	—
		50	123 ~ 333	—	4000	—	10000
	X7R	50	823 ~ 224	—	3000	—	10000
		100	473 ~ 823	—	4000	—	10000
		200	223 ~ 473	—	3000	—	10000

15. Reel Specifications

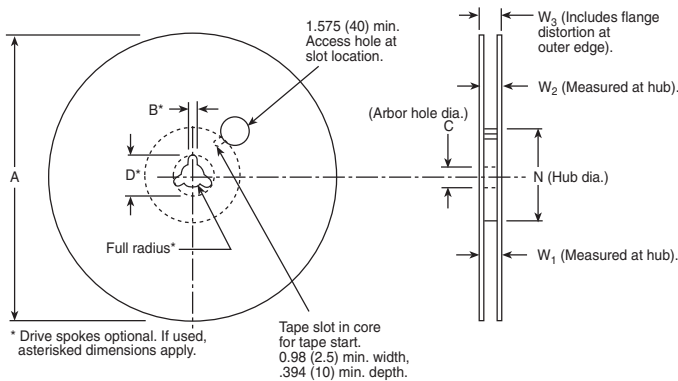

Reel Dimensions

Tape Size ⁽¹⁾	Dimensions inches (mm)							
	A Max.	B* Min.	C	D* Min.	N Min.	W ₁	W ₂ Max.	W ₃
8mm	12.992 (330)	0.059 (1.5)	0.512 ± 0.008 (13.0 ± 0.20)	.795 (20.2)	1.969 (50)	.331 ^{±.060} _{-.00} (8.4 ^{±.1} ₀)	.567 (14.4)	.311 (7.9 Min.)
								.429 (10.9 Max.)
12mm	12.992 (330)	0.059 (1.5)	0.512 ± 0.008 (13.0 ± 0.20)	.795 (20.2)	1.969 (50)	.488 ^{±.076} _{-.00} (12.4 ^{±.2} ₀)	.724 (18.4)	.469 (11.9 Min.)
								.607 (15.4 Max.)

Metric dimensions will govern. English measurements rounded and for reference only.
(1) For tape sizes 16mm and 24mm (used with chip size 3640) consult EIA RS-481 latest revision.

16. Carrier Tape Specifications

Embossed plastic
8 & 12mm

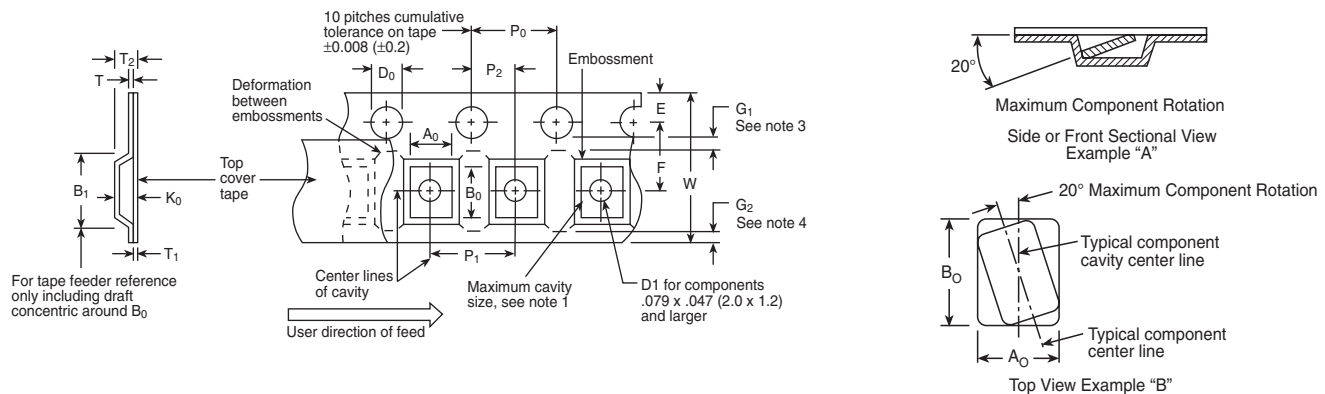

Tape Size <i>Constant</i>	Dimensions inches (mm)							
	D ₀	E	P ₀	P ₂	T Max.	T ₁	G ₁	G ₂
8mm, 12mm	.059 ± ^{.004} _{0.0} (1.5 ± ^{0.10} _{0.0})	.069 ± .004 (1.75 ± 0.10)	.157 ± .004 (4.0 ± 0.10)	.079 ± .002 (2.0 ± 0.05)	.024 (0.600)	.004 (0.10) Max.	.030 (0.75) Min. See note 3	.030 (0.75) Min. See note 4

Tape Size <i>Variable</i>	Dimensions inches (mm)							
	B ₁ Max. See note 6	D ₁ Min. See note 5	F	P ₁	R Min. See note 2	T ₂	W	A ₀ B ₀ K ₀
8mm	.179 (4.55)	.039 (1.0)	.138 ± .002 (3.5 ± 0.05)	.157 ± .004 (4.0 ± 0.10)	.984 (25)	.098 (2.5 Max.)	.315 ± ^{.012} _{.004} (8.0 ± ^{0.3} _{0.1})	See note 1
12mm	.323 (8.2)	.059 (1.5)	.217 ± .002 (5.5 ± 0.05)	.157 ± .004 (4.0 ± 0.10)	1.181 (30)	.256 (6.5 Max.)	.472 ± .012 (12.0 ± .30)	See note 1
12mm 1/2 Pitch	.179 (4.55)	.039 (1.0)	.138 ± .002 (3.5 ± 0.05)	.079 ± .004 (2.0 ± 0.10)	.984 (25)	.098 (2.5 Max.)	.315 ± ^{.012} _{.004} (8.0 ± ^{0.3} _{0.1})	See note 1
12mm Double Pitch	.323 (8.2)	.059 (1.5)	.217 ± .002 (5.5 ± 0.05)	.315 ± .004 (8.0 ± 0.10)	1.181 (30)	.256 (6.5 Max.)	.472 ± .012 (12.0 ± .30)	See note 1

Notes:

- A₀, B₀ and K₀ are determined by the max. dimensions to the ends of the terminals extending from the components body and/or the body of the component. The clearance between the end of the terminals of the body of the components to the sides and depth of the cavity (A₀, B₀ and K₀) must be within .002" (0.05)mm min. and .020" (0.50)mm max. The clearance allowed must also prevent rotation of the component within the cavity of not more than 20 degrees (see examples A & B).
- Tape with components shall pass around radius "R" without damage. The minimum trailer length (Note 2 Fig. 3) may require additional length to provide R min. for .472" (12)mm embossed tape for reels with hub diameters approaching N min. (Table 4).
- G₁ dimension is the flat area from the edge of the sprocket hole to either the outward deformation of the carrier tape between the embossed cavities or to the edge of the cavity whichever is less.
- G₂ dimension is the flat area from the edge of the carrier tape opposite the sprocket holes to either the outward deformation of the carrier tape between the embossed cavity or to the edge of the cavity whichever is less.
- The embossed hole location shall be measured from the sprocket hole controlling the location of the embossment. Dimensions of embossment location and hole location shall be applied independent of each other.
- B₁ dimension is a reference dimension for tape feeder clearance only.

17. Carrier Tape Specifications

Punched paper tape
8 & 12mm

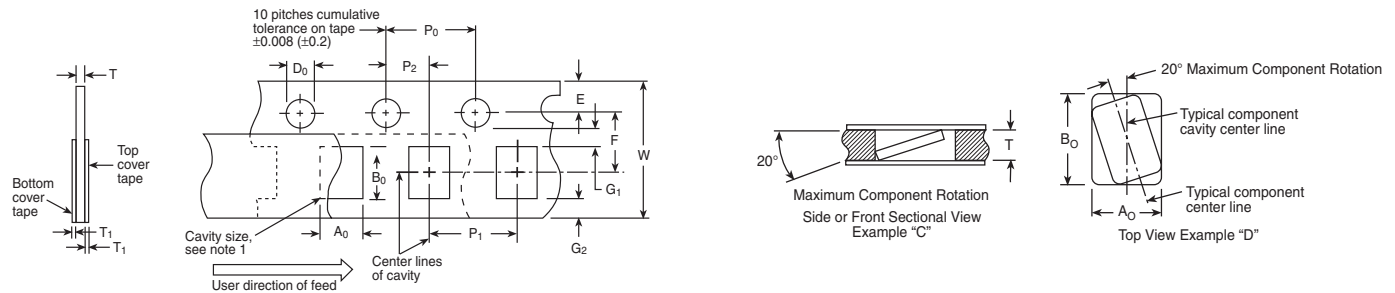

Carrier Tape Dimensions

Tape Size <i>Constant</i>	Dimensions inches (mm)						
	D_0	E	P_0	P_2	T_1	G_1	
8mm	$.059 \pm .004$ (1.5 ± 0.1)	$.069 \pm .004$ (1.75 ± 0.10)	$.157 \pm .004$ (4.0 ± 0.10)	$.079 \pm .002$ (2.0 ± 0.05)	$.004$ (0.10)	$.030$ (0.75)	$.984$ (25)
12mm					Max.	Min.	See note 2

Tape Size <i>Variable</i>	Dimensions inches (mm)				
	P_1	F	W	$A_0 B_0$	T
8mm	$.157 \pm .004$ (4.0 ± 0.10)	$.138 \pm .002$ (3.5 ± 0.05)	$.315 \pm .012$ (8.0 ± 0.3)	See note 1	See note 3
12mm	$.157 \pm .004$ (4.0 ± 0.10)	$.217 \pm .002$ (5.5 ± 0.05)	$.472 \pm .012$ (12.0 ± 0.3)		
8mm 1/2 Pitch	$.079 \pm .004$ (2.0 ± 0.10)	$.138 \pm .002$ (3.5 ± 0.05)	$.315 \pm .012$ (8.0 ± 0.3)		
12mm Double Pitch	$.315 \pm .004$ (8.0 ± 0.10)	$.217 \pm .002$ (5.5 ± 0.05)	$.472 \pm .012$ (12.0 ± 0.3)		

Notes:

- A_0 , B_0 and T are determined by the max. dimensions to the ends of the terminals extending from the component body and/or the body dimensions of the component. The clearance between the ends of the terminals or body of the components to the sides and depth of the cavity (A_0 , B_0 and T) must be within .002" (0.05) mm min. and .020" (0.50) mm max. The clearance allowed must also prevent rotation of the component within the cavity of not more than 20 degrees (see examples C & D).
- Tape with components shall pass around radius "R" without damage.
- .043" (1.1) mm base tape and .063" (1.6) mm max. for non-paper base compositions.

18. Recommended Land Pattern Dimensions

Component pads should be designed to achieve good solder fillets and minimize component movement during reflow soldering. Pad dimensions are given below for multilayer ceramic capacitors for both reflow and wave soldering. The basis for these designs is:

- Pad width equal to component width. It is permissible to decrease this to as low as 85% of component width but it is not advisable to go below this.
- Pad overlap 0.5mm beneath component
- Pad extension 0.5mm beyond components for reflow and 1.0mm for wave soldering

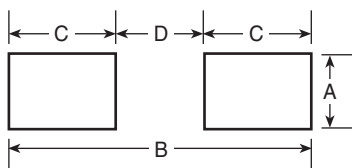

Case Size	Dimensions inches (mm)			
	A	B	C	D
0402	0.02 (0.50)	0.07 (1.70)	0.02 (0.60)	0.02 (0.50)
0603	0.03 (0.75)	0.09 (2.30)	0.03 (0.80)	0.03 (0.70)
0805	0.05 (1.25)	0.12 (3.00)	0.04 (1.00)	0.04 (1.00)
1206	0.06 (1.60)	0.16 (4.00)	0.04 (1.00)	0.09 (2.00)
1210	0.10 (2.50)	0.16 (4.00)	0.04 (1.00)	0.09 (2.00)

Mouser Electronics

Authorized Distributor

Click to View Pricing, Inventory, Delivery & Lifecycle Information:

KOA Speer:

[NPO1206ITTD330J](#) [NPO0603HTTD100J](#) [NPO0402HTTP220J](#) [NPO1206JTDD681J](#) [Y5V0402CTTP104Z](#)
[Y5V0805CTTE105Z](#) [NPO0402HTTP1R2C](#) [NPO0603HTTD5R6C](#) [NPO0603HTTD270G](#) [NPO0603HTTD330J](#)
[Y5V0805CTTD105Z](#) [X7R0603HTTD223K](#) [NPO0402HTTP680J](#)