

NUP3115UPMU

ESD Protection Diode

Low Capacitance ESD Protection for High Speed Data

The three-line voltage transient suppressor array is designed to protect voltage-sensitive components that require ultra-low capacitance from ESD and transient voltage events. This device features a common anode design which protects three independent high speed data lines and a V_{CC} power line in a single six-lead UDFN low profile package.

Excellent clamping capability, low capacitance, low leakage, and fast response time make these parts ideal for ESD protection on designs where board space is at a premium. Because of its low capacitance, it is suited for use in high frequency designs such as a USB 2.0 high speed.

Features

- Low Capacitance 0.8 pF
- UDFN Package, 1.6 x 1.6 mm
- Low Profile of 0.50 mm for Ultra Slim Design
- Stand Off Voltage: 5.5 V
- Low Leakage
- Protects up to Three Data Lines Plus a V_{CC} Pin
- V_{CC} Pin = 15 V Protection
- D₁, D₂, and D₃ Pins = 6.4 V Minimum Protection
- IEC61000-4-2: Level 4 ESD Protection
- This is a Pb-Free Device

Typical Applications

- USB 2.0 High-Speed Interface
- Cell Phones
- MP3 Players
- SIM Card Protection

MAXIMUM RATINGS (T_J = 25°C, unless otherwise specified)

Symbol	Rating	Value	Unit
I _{PK}	Peak Pulse Current V _{CC} Diode 8x20 μsec double exponential waveform	5.0	A
T _J	Operating Junction Temperature Range	-40 to 125	°C
T _{STG}	Storage Temperature Range	-55 to 150	°C
T _L	Lead Solder Temperature – Maximum (10 seconds)	260	°C
ESD	IEC 61000-4-2 Contact	8000	V

Stresses exceeding those listed in the Maximum Ratings table may damage the device. If any of these limits are exceeded, device functionality should not be assumed, damage may occur and reliability may be affected.

See Application Note AND8308/D for further description of survivability specs.



ON Semiconductor®

www.onsemi.com

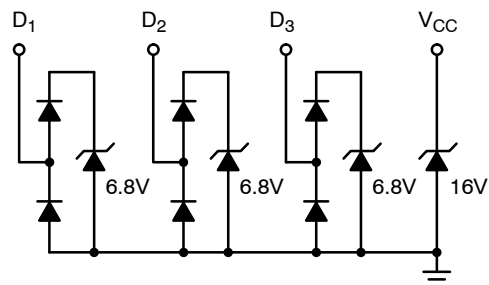

MARKING DIAGRAM



UDFN6 1.6x1.6
MU SUFFIX
CASE 517AP

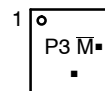

- P3 = Specific Device Code
- M = Date Code
- = Pb-Free Package

(Note: Microdot may be in either location)

PIN CONNECTIONS

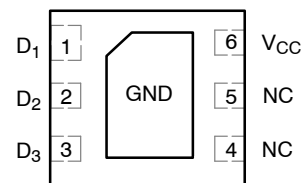

ORDERING INFORMATION

Device	Package	Shipping†
NUP3115UPMUTAG	UDFN6 (Pb-Free)	3000/Tape & Reel

†For information on tape and reel specifications, including part orientation and tape sizes, please refer to our Tape and Reel Packaging Specification Brochure, BRD8011/D.

NUP3115UPMU

ELECTRICAL CHARACTERISTICS

($T_A = 25^\circ\text{C}$ unless otherwise noted)

Symbol	Parameter
I_{PP}	Maximum Reverse Peak Pulse Current
V_C	Clamping Voltage @ I_{PP}
V_{RWM}	Working Peak Reverse Voltage
I_R	Maximum Reverse Leakage Current @ V_{RWM}
V_{BR}	Breakdown Voltage @ I_T
I_T	Test Current
I_F	Forward Current
V_F	Forward Voltage @ I_F
P_{pk}	Peak Power Dissipation
C	Max. Capacitance @ $V_R = 0$ and $f = 1.0$ MHz

*See Application Note AND8308/D for detailed explanations of datasheet parameters.

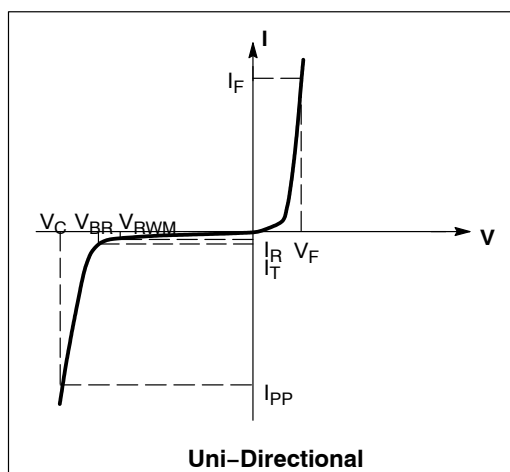

ELECTRICAL CHARACTERISTICS ($T_J = 25^\circ\text{C}$, unless otherwise specified)

Parameter	Conditions	Symbol	Min	Typ	Max	Unit
Reverse Working Voltage ($D_1, D_2,$ and D_3)	(Note 1)	V_{RWM1}	-	-	5.5	V
Reverse Working Voltage (V_{CC})	(Note 1)	V_{RWM2}	-	-	12	V
Breakdown Voltage ($D_1, D_2,$ and D_3)	$I_T = 1$ mA, (Note 2)	V_{BR}	6.0	6.8	8.0	V
Breakdown Voltage (V_{CC})	$I_T = 1$ mA, (Note 2)	V_{BR2}	15	16	16.8	V
Reverse Leakage Current ($D_1, D_2,$ and D_3)	@ V_{RWM1}	I_R	-	-	1.0	μA
Reverse Leakage Current ($D_1, D_2,$ and D_3)	@ 3.3 V	I_R	-	-	85	nA
Reverse Leakage Current (V_{CC})	@ V_{RWM2}	I_R	-	-	1.0	μA
Clamping Voltage ($D_1, D_2,$ and D_3)	$I_{PP} = 1$ A	V_C	-	9.4	-	V
Clamping Voltage (V_{CC})	$I_{PP} = 1$ A	V_C	-	18.5	-	V
Clamping Voltage (V_{CC})	$I_{PP} = 3$ A	V_C	-	22	-	V
Junction Capacitance ($D_1, D_2,$ and D_3)	$V_R = 0$ V, $f = 1$ MHz (Line to GND)	C_J	-	0.8	1.0	pF
Clamping Voltage	Per IEC 61000-4-2 (Note 4)	VC	Figure 1 and 2			V

1. Surge protection devices are normally selected according to the working peak reverse voltage (V_{RWM}), which should be equal or greater than the DC or continuous peak operating voltage level.
2. V_{BR} is measured at pulse test current I_T .
3. Surge current waveform per Figure 5.
4. Typical waveform. For test procedure see Figures 3 and 4 and Application Note AND8307/D.

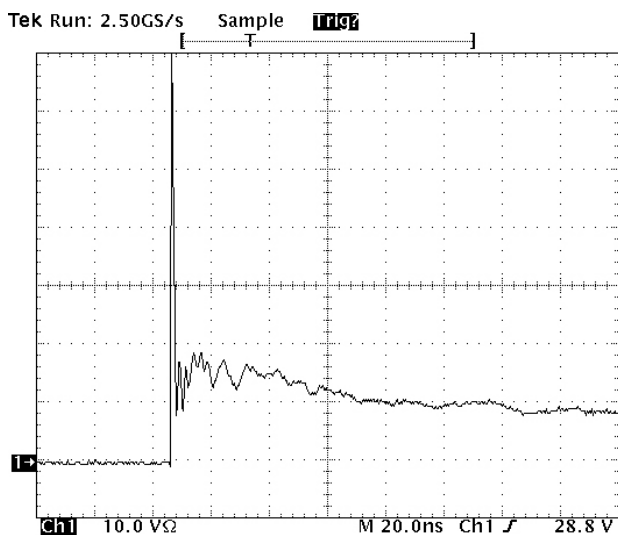

Figure 1. ESD Clamping Voltage Screenshot Positive 8 kV Contact per IEC61000-4-2

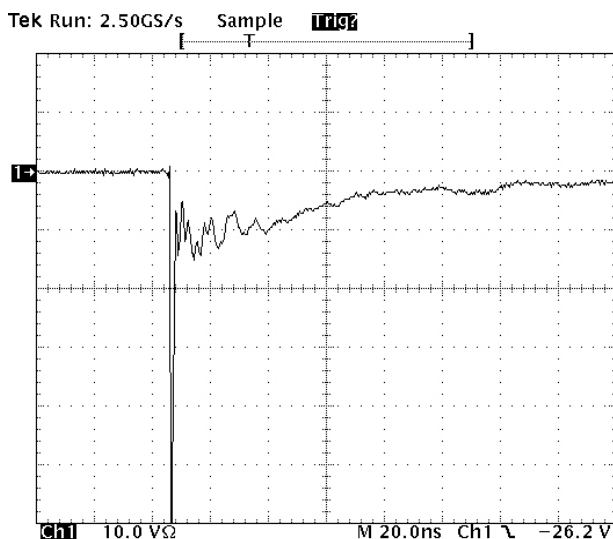

Figure 2. ESD Clamping Voltage Screenshot Negative 8 kV Contact per IEC61000-4-2

NUP3115UPMU

IEC 61000-4-2 Spec.

Level	Test Voltage (kV)	First Peak Current (A)	Current at 30 ns (A)	Current at 60 ns (A)
1	2	7.5	4	2
2	4	15	8	4
3	6	22.5	12	6
4	8	30	16	8

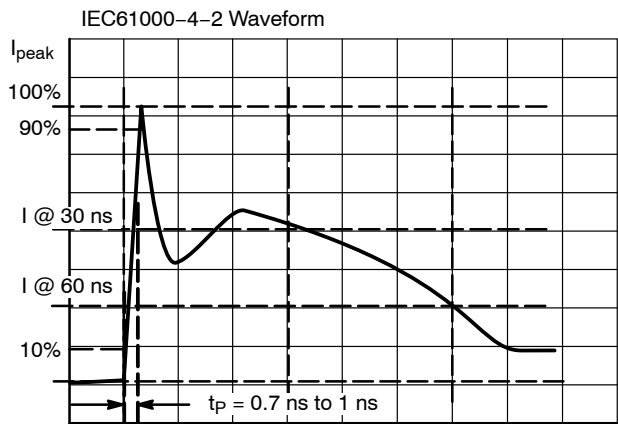

Figure 3. IEC61000-4-2 Spec

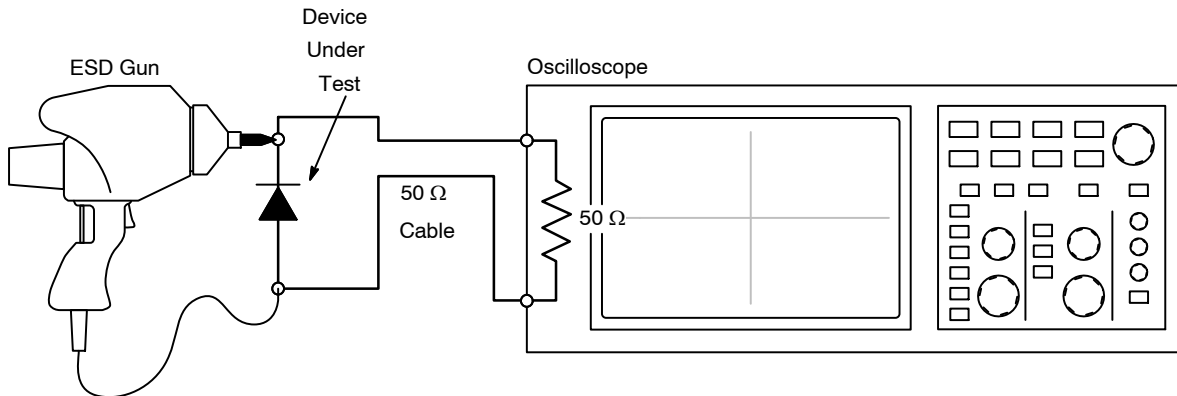

Figure 4. Diagram of ESD Test Setup

The following is taken from Application Note AND8308/D – Interpretation of Datasheet Parameters for ESD Devices.

ESD Voltage Clamping

For sensitive circuit elements it is important to limit the voltage that an IC will be exposed to during an ESD event to as low a voltage as possible. The ESD clamping voltage is the voltage drop across the ESD protection diode during an ESD event per the IEC61000-4-2 waveform. Since the IEC61000-4-2 was written as a pass/fail spec for larger

systems such as cell phones or laptop computers it is not clearly defined in the spec how to specify a clamping voltage at the device level. ON Semiconductor has developed a way to examine the entire voltage waveform across the ESD protection diode over the time domain of an ESD pulse in the form of an oscilloscope screenshot, which can be found on the datasheets for all ESD protection diodes. For more information on how ON Semiconductor creates these screenshots and how to interpret them please refer to AND8307/D.

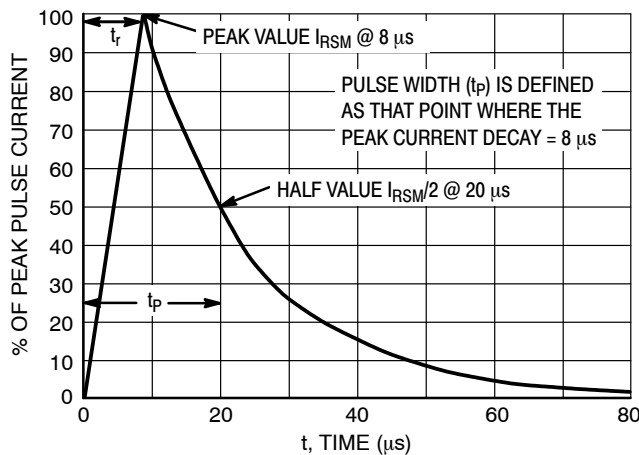
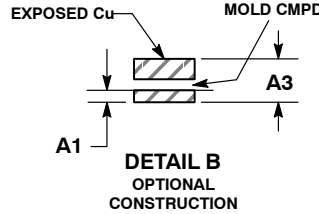
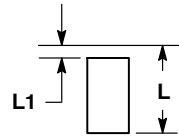
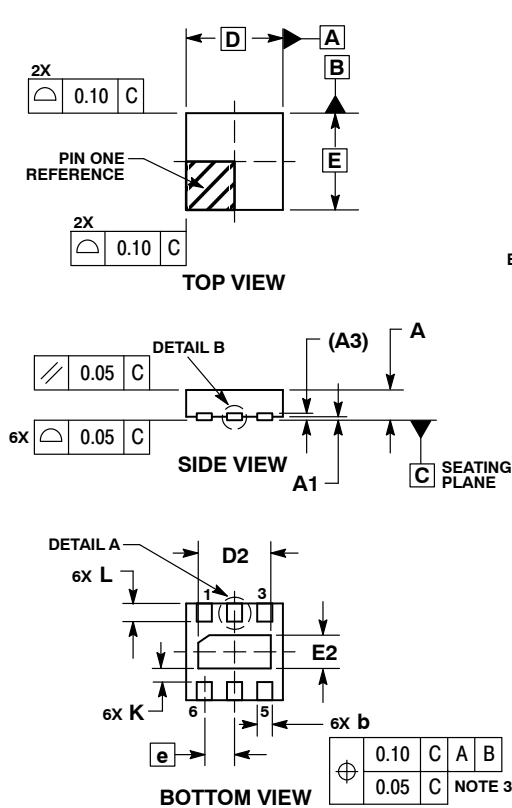

Figure 5. 8 x 20 μs Pulse Waveform

NUP3115UPMU

PACKAGE DIMENSIONS

UDFN6, 1.6 x 1.6, 0.5P
CASE 517AP-01
ISSUE O



NOTES:

1. DIMENSIONING AND TOLERANCING PER ASME Y14.5M, 1994.
2. CONTROLLING DIMENSION: MILLIMETERS.
3. DIMENSION b APPLIES TO PLATED TERMINAL AND IS MEASURED BETWEEN 0.15 AND 0.30 mm FROM TERMINAL.
4. COPLANARITY APPLIES TO THE EXPOSED PAD AS WELL AS THE TERMINALS.

MILLIMETERS		
DIM	MIN	MAX
A	0.45	0.55
A1	0.00	0.05
A3	0.13	REF
b	0.20	0.30
D	1.60	BSC
E	1.60	BSC
e	0.50	BSC
D2	1.10	1.30
E2	0.45	0.65
K	0.20	---
L	0.20	0.40
L1	0.00	0.15

SOLDERMASK DEFINED MOUNTING FOOTPRINT*

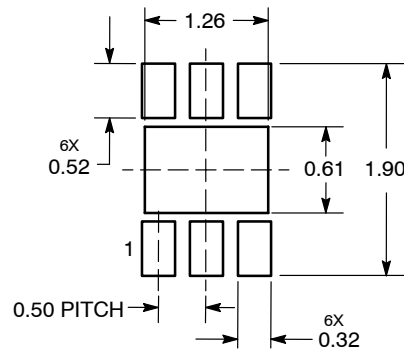

DIMENSIONS: MILLIMETERS

*For additional information on our Pb-Free strategy and soldering details, please download the ON Semiconductor Soldering and Mounting Techniques Reference Manual, SOLDERRM/D.

ON Semiconductor and are trademarks of Semiconductor Components Industries, LLC dba ON Semiconductor or its subsidiaries in the United States and/or other countries. ON Semiconductor owns the rights to a number of patents, trademarks, copyrights, trade secrets, and other intellectual property. A listing of ON Semiconductor's product/patent coverage may be accessed at www.onsemi.com/site/pdf/Patent-Marking.pdf. ON Semiconductor reserves the right to make changes without further notice to any products herein. ON Semiconductor makes no warranty, representation or guarantee regarding the suitability of its products for any particular purpose, nor does ON Semiconductor assume any liability arising out of the application or use of any product or circuit, and specifically disclaims any and all liability, including without limitation special, consequential or incidental damages. Buyer is responsible for its products and applications using ON Semiconductor products, including compliance with all laws, regulations and safety requirements or standards, regardless of any support or applications information provided by ON Semiconductor. "Typical" parameters which may be provided in ON Semiconductor data sheets and/or specifications can and do vary in different applications and actual performance may vary over time. All operating parameters, including "Typicals" must be validated for each customer application by customer's technical experts. ON Semiconductor does not convey any license under its patent rights nor the rights of others. ON Semiconductor products are not designed, intended, or authorized for use as a critical component in life support systems or any FDA Class 3 medical devices or medical devices with a same or similar classification in a foreign jurisdiction or any devices intended for implantation in the human body. Should Buyer purchase or use ON Semiconductor products for any such unintended or unauthorized application, Buyer shall indemnify and hold ON Semiconductor and its officers, employees, subsidiaries, affiliates, and distributors harmless against all claims, costs, damages, and expenses, and reasonable attorney fees arising out of, directly or indirectly, any claim of personal injury or death associated with such unintended or unauthorized use, even if such claim alleges that ON Semiconductor was negligent regarding the design or manufacture of the part. ON Semiconductor is an Equal Opportunity/Affirmative Action Employer. This literature is subject to all applicable copyright laws and is not for resale in any manner.

PUBLICATION ORDERING INFORMATION

LITERATURE FULFILLMENT:

Literature Distribution Center for ON Semiconductor
19521 E. 32nd Pkwy, Aurora, Colorado 80011 USA
Phone: 303-675-2175 or 800-344-3860 Toll Free USA/Canada
Fax: 303-675-2176 or 800-344-3867 Toll Free USA/Canada
Email: orderlit@onsemi.com

N. American Technical Support: 800-282-9855 Toll Free
USA/Canada
Europe, Middle East and Africa Technical Support:
Phone: 421 33 790 2910
Japan Customer Focus Center
Phone: 81-3-5817-1050

ON Semiconductor Website: www.onsemi.com

Order Literature: <http://www.onsemi.com/orderlit>

For additional information, please contact your local Sales Representative

Mouser Electronics

Authorized Distributor

Click to View Pricing, Inventory, Delivery & Lifecycle Information:

[ON Semiconductor:](#)

[NUP3115UPMUTAG](#)