

ISL80102, ISL80103

High Performance 2A and 3A Linear Regulators

FN6660
Rev 9.00
Mar 19, 2018

The [ISL80102](#) and [ISL80103](#) are low voltage, high-current, single output LDOs specified for 2A and 3A output current, respectively. These LDOs operate from the input voltages of 2.2V to 6V and are capable of providing the output voltages of 0.8V to 5.5V on the adjustable V_{OUT} versions. Other custom voltage options are available upon request.

An external capacitor on the soft-start pin provides adjustment for applications that demand inrush current less than the current limit. The ENABLE feature allows the part to be placed into a low quiescent current shutdown mode. A submicron BiCMOS process is used for this product family to deliver best-in-class analog performance and overall value.

These CMOS (LDOs) consume significantly lower quiescent current as a function of load over bipolar LDOs, so they are more efficient and allow packages with smaller footprints. The quiescent current has been modestly compromised to enable a leading class fast load transient response, and hence a lower total AC regulation band for an LDO in this category.

Related Literature

For a full list of related documents, visit our website

- [ISL80102](#), [ISL80103](#) product pages

Features

- Stable with ceramic capacitors ([Note 11](#))
- 2A and 3A output current ratings
- 2.2V to 6V input voltage range
- $\pm 1.8\%$ V_{OUT} accuracy guaranteed over line, load, and $T_J = -40^\circ\text{C}$ to $+125^\circ\text{C}$
- Very low 120mV dropout voltage at 3A (ISL80103)
- Very fast transient response
- Excellent 62dB PSRR
- $49\mu\text{V}_{RMS}$ output noise
- Power-good output
- Adjustable inrush current limiting
- Short-circuit and over-temperature protection
- Available in a 10 Ld DFN

Applications

- Servers
- Telecommunications and networking
- Medical equipment
- Instrumentation systems
- Routers and switchers

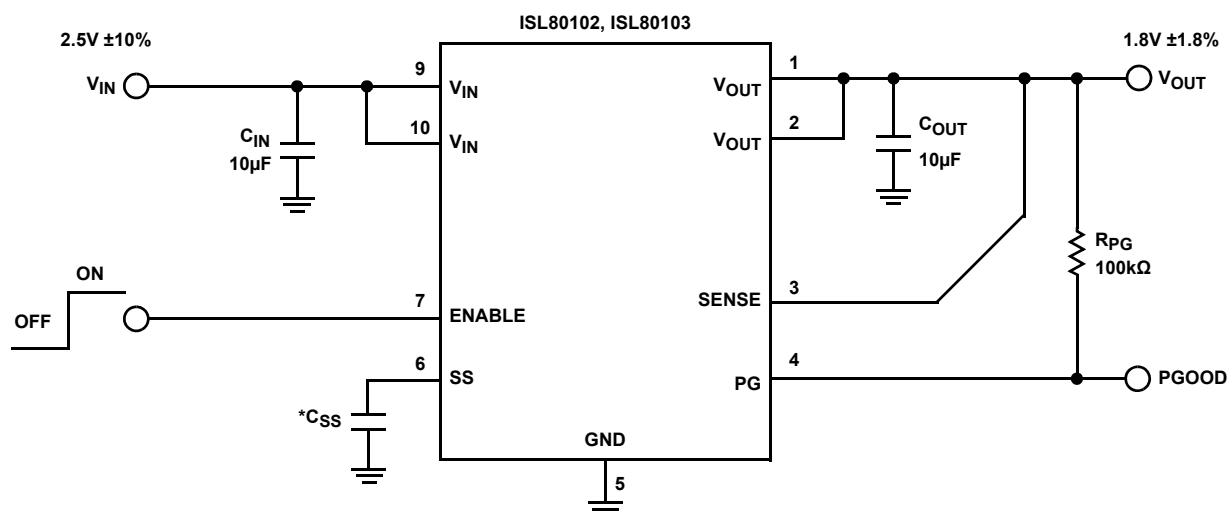

*CSS is optional (see [Note 12 on page 5](#)).

FIGURE 1. TYPICAL APPLICATION FOR FIXED OUTPUT VOLTAGE VERSION

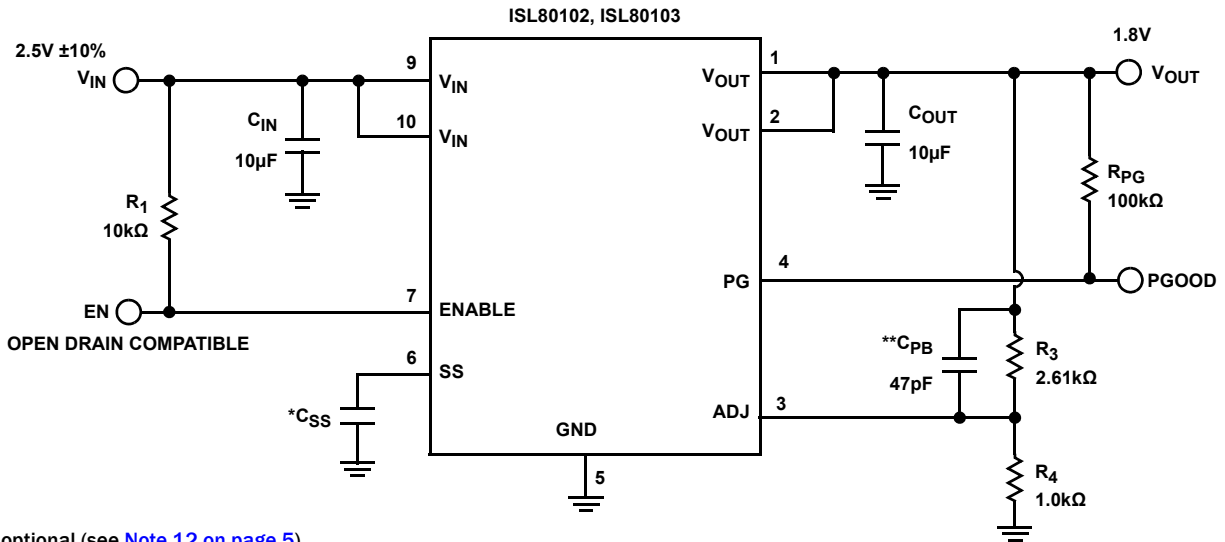

*CSS is optional (see [Note 12 on page 5](#)).

**CPB is optional (see [“Functional Description” on page 12](#) for more information).

FIGURE 2. TYPICAL APPLICATION DIAGRAM FOR ADJUSTABLE OUTPUT VOLTAGE VERSION

TABLE 1. COMPONENTS VALUE SELECTION

V _{OUT} (V)	R _{TOP} (kΩ)	R _{BOTTOM} (Ω)	C _{PB} (pF)	C _{OUT} (µF)
5.0	2.61	287	47	10
3.3	2.61	464	47	10
2.5	2.61	649	47	10
1.8 (Note 1)	2.61	1.0k	47	10
1.8 (Note 1)	2.61	1.0k	82	22
1.5	2.61	1.3k	82	22
1.2	2.61	1.87k	150	47
1.0	2.61	2.61k	150	47
0.8	2.61	4.32k	150	47

NOTE:

1. Either option can be used depending on cost/performance requirements

Pin Configuration

ISL80102, ISL80103
(10 LD 3x3 DFN)
TOP VIEW

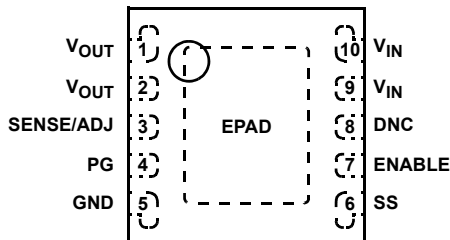

Pin Descriptions

PIN NUMBER	PIN NAME	DESCRIPTION
1, 2	V _{OUT}	Output voltage pin
3	SENSE/ADJ	Remote voltage sense for internally fixed V _{OUT} options. ADJ pin for externally set V _{OUT} .
4	PG	V _{OUT} in regulation signal. Logic low defines when V _{OUT} is not in regulation. Must be grounded if not used.
5	GND	GND pin
6	SS	External cap adjusts inrush current. Leave this pin open if not used.
7	ENABLE	V _{IN} independent chip enable. TTL and CMOS compatible.
8	DNC	Do not connect this pin to ground or supply. Leave floating.
9, 10	V _{IN}	Input supply pin
	EPAD	EPAD must be connected to a copper plane with as many vias as possible for proper electrical and optimal thermal performance.

Block Diagram

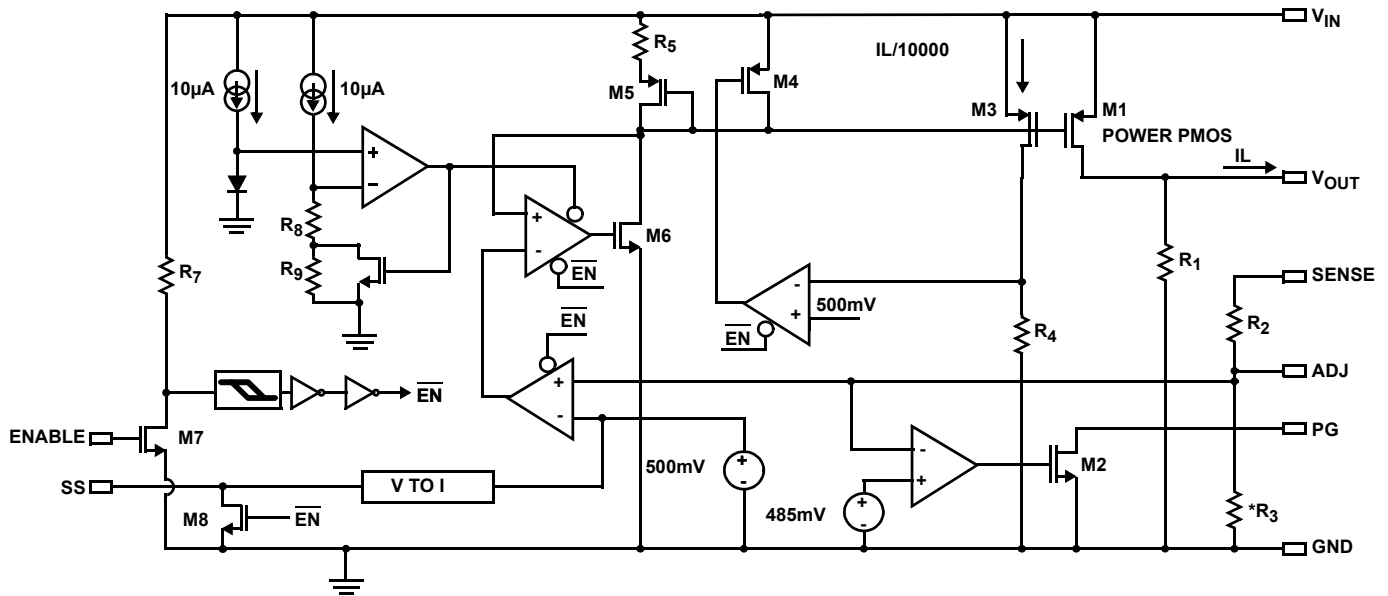

*R₃ is open for ADJ versions.

FIGURE 3. BLOCK DIAGRAM

Ordering Information

PART NUMBER (Notes 4, 5)	PART MARKING	V _{OUT} VOLTAGE	TEMP. RANGE (°C)	PACKAGE (RoHS COMPLIANT)	PKG DWG. #
ISL80102IRAJZ (Note 2)	DZJA	ADJ	-40 to +125	10 Ld 3x3 DFN	L10.3x3
ISL80102IR18Z (Note 3) (No longer available, recommended replacement: ISL80102IRAJZ)	DZNA	1.8V	-40 to +125	10 Ld 3x3 DFN	L10.3x3
ISL80102IR25Z (Note 3) (No longer available, recommended replacement: ISL80102IRAJZ)	DZPA	2.5V	-40 to +125	10 Ld 3x3 DFN	L10.3x3
ISL80103IRAJZ (Note 2)	DZAA	ADJ	-40 to +125	10 Ld 3x3 DFN	L10.3x3
ISL80103IR18Z (Note 3) (No longer available, recommended replacement: ISL80103IRAJZ)	DZEA	1.8V	-40 to +125	10 Ld 3x3 DFN	L10.3x3
ISL80103IR25Z (Note 3) (No longer available, recommended replacement: ISL80103IRAJZ)	DZFA	2.5V	-40 to +125	10 Ld 3x3 DFN	L10.3x3
ISL80102EVAL2Z	Evaluation Board				
ISL80103EVAL2Z	Evaluation Board				

NOTES:

2. Add "-T" suffix for 6k unit, "-TK" suffix for 1k unit, or "-T7A" suffix for 250 unit tape and reel options. Refer to [TB347](#) for details about reel specifications.
3. Add "-T" suffix for 6k unit or "-TK" suffix for 1k unit tape and reel options. Refer to [TB347](#) for details about reel specifications.
4. These Pb-free plastic packaged products employ special Pb-free material sets, molding compounds/die attach materials, and 100% matte tin plate plus anneal (e3 termination finish, which is RoHS compliant and compatible with both SnPb and Pb-free soldering operations). Pb-free products are MSL classified at Pb-free peak reflow temperatures that meet or exceed the Pb-free requirements of IPC/JEDEC J STD-020.
5. For Moisture Sensitivity Level (MSL), refer to the [ISL80102](#) and [ISL80103](#) product information pages. For more information about MSL, refer to [TB363](#).

Absolute Maximum Ratings (Note 8)

V_{IN} Relative to GND	-0.3V to +6.5V
V_{OUT} Relative to GND	-0.3V to +6.5V
PG, ENABLE, SENSE/ADJ, SS, Relative to GND	-0.3V to +6.5V
ESD Rating	
Human Body Model (Tested per JESD22 A114F)	2.2kV
Charge Device Model (Tested per JESD22-C101C)	1kV
Latch-up (Tested per JESD78C, Class 2, Level A)	± 100 mA at +85°C

Thermal Information

Thermal Resistance (Typical)	θ_{JA} (°C/W)	θ_{JC} (°C/W)
10 Ld 3x3 DFN Package (Notes 6, 7)	45	4
Maximum Junction Temperature (Plastic Package)	+150°C	
Storage Temperature Range	-65°C to +150°C	
Pb-Free Reflow Profile	see TB493	

Recommended Operating Conditions

Junction Temperature Range (T_J)	-40°C to +125°C
V_{IN} Relative to GND	2.2V to 6V
V_{OUT} Range	800mV to 5.5V
PG, ENABLE, SENSE/ADJ, SS Relative to GND	0V to 6V
PG Sink Current	10mA

CAUTION: Do not operate at or near the maximum ratings listed for extended periods of time. Exposure to such conditions may adversely impact product reliability and result in failures not covered by warranty.

NOTES:

- θ_{JA} is measured in free air with the component mounted on a high-effective thermal conductivity test board with “direct attach” features. Refer to [TB379](#).
- For θ_{JC} , the “case temp” location is the center of the exposed metal pad on the package underside.
- ABS max voltage rating is defined as the voltage applied for a lifetime average duty cycle above 6V of 1%.

Electrical Specifications

Unless otherwise noted, all parameters are established over the following specified conditions: 2.2V < V_{IN} < 6V, V_{OUT} = 0.5V, T_J = +25°C, I_{LOAD} = 0A. Applications must follow thermal guidelines of the package to determine worst case junction temperature. Refer to [“Functional Description” on page 12](#) and [TB379](#). **Boldface limits apply across the operating temperature range, -40°C to +125°C.** Pulse load techniques used by ATE to ensure $T_J = T_A$ defines established limits.

PARAMETER	SYMBOL	TEST CONDITIONS	MIN (Note 9)	TYP	MAX (Note 9)	UNIT
DC CHARACTERISTICS						
DC Output Voltage Accuracy	V_{OUT}	V_{OUT} options: 1.8V 2.2V < V_{IN} < 6V; I_{LOAD} = 0A		0.5		%
		V_{OUT} options: 1.8V 2.2V < V_{IN} < 6V; 0A < I_{LOAD} < 3A	-1.8		1.8	%
		V_{OUT} options: 2.5V 6V < V_{IN} < 6V; I_{LOAD} = 0A		0.5		%
		V_{OUT} options: 2.5V 6V < V_{IN} < 6V; 0A < I_{LOAD} < full load	-1.8		-1.8	%
Feedback Pin (ADJ Version)	V_{ADJ}	0A < I_{LOAD} < full load	491	500	509	mV
DC Input Line Regulation	$(V_{OUT}$ Low Line - V_{OUT} High Line) / V_{OUT} Low Line	2.2V < V_{IN} < 3.6V, V_{OUT} = 1.8V	-0.4	0.1	0.4	%
		2.9V < V_{IN} < 6V, V_{OUT} = 2.5V	-0.8	0.1	0.8	%
DC Output Load Regulation	$(V_{OUT}$ No Load - V_{OUT} High Load) / V_{OUT} No Load	ISL80103, 0A < I_{LOAD} < 3A, 2.9V < V_{IN} < 6V; V_{OUT} = 2.5V for adjustable version. V_{OUT} = 1.8V and 2.5V for fixed version.	-0.8	-0.2	0.8	%
		ISL80102, 0A < I_{LOAD} < 2A 2.9V < V_{IN} < 6V; V_{OUT} = 2.5V for adjustable version. V_{OUT} = 1.8V and 2.5V for fixed version.	-0.6	-0.2	0.6	%
Feedback Input Current		V_{ADJ} = 0.5V		0.01	1	μ A
Ground Pin Current	I_Q	I_{LOAD} = 0A, V_{OUT} + 0.4V < V_{IN} < 6V for all options. V_{OUT} = 2.5V for adjustable option.		7.5	9	mA
		I_{LOAD} = 3A, V_{OUT} + 0.4V < V_{IN} < 6V for all options. V_{OUT} = 2.5V for adjustable option.		8.5	12	mA

Electrical Specifications

Unless otherwise noted, all parameters are established over the following specified conditions:

$2.2V < V_{IN} < 6V$, $V_{OUT} = 0.5V$, $T_J = +25^\circ C$, $I_{LOAD} = 0A$. Applications must follow thermal guidelines of the package to determine worst case junction temperature. Refer to "[Functional Description](#)" on page 12 and [TB379](#). **Boldface limits apply across the operating temperature range, $-40^\circ C$ to $+125^\circ C$.** Pulse load techniques used by ATE to ensure $T_J = T_A$ defines established limits. (Continued)

PARAMETER	SYMBOL	TEST CONDITIONS	MIN (Note 9)	TYP	MAX (Note 9)	UNIT
Ground Pin Current in Shutdown	I_{SHDN}	$EN = 0V$, $V_{IN} = 5V$		0.4		μA
		$EN = 0V$, $V_{IN} = 6V$		3.3	16.0	μA
Dropout Voltage (Note 10)	V_{DO}	ISL80103, $I_{LOAD} = 3A$, $V_{OUT} = 2.5V$		120	185	mV
		ISL80102, $I_{LOAD} = 2A$, $V_{OUT} = 2.5V$		81	125	mV
		ISL80103, $I_{LOAD} = 3A$, $V_{OUT} = 5.5V$		120	244	mV
		ISL80102, $I_{LOAD} = 2A$, $V_{OUT} = 5.5V$		60	121	mV
Output Short-Circuit Current (3A Version)	ISC	ISL80103, $V_{OUT} = 0V$		5.0		A
Output Short-Circuit Current (2A Version)		ISL80102, $V_{OUT} = 0V$		2.8		A
Thermal Shutdown Temperature	TSD			160		$^\circ C$
Thermal Shutdown Hysteresis	TSDn			15		$^\circ C$
AC CHARACTERISTICS						
Input Supply Ripple Rejection	PSRR	$f = 1kHz$, $I_{LOAD} = 1A$; $V_{IN} = 2.2V$		55		dB
		$f = 120Hz$, $I_{LOAD} = 1A$; $V_{IN} = 2.2V$		62		dB
Output Noise Voltage		$V_{IN} = 2.2V$, $V_{OUT} = 1.8V$, $I_{LOAD} = 3A$, $BW = 100Hz < f < 100kHz$		49		μV_{RMS}
ENABLE PIN CHARACTERISTICS						
Turn-On Threshold	$V_{EN(HIGH)}$	$2.9V < V_{IN} < 6V$ for 2.5V for fixed output option. $2.2V < V_{IN} < 6V$ for adjustable and 1.8V	0.616	0.800	0.950	V
Turn-Off Threshold	$V_{EN(LOW)}$	$2.9V < V_{IN} < 6V$ for 2.5V fixed output option. $2.2V < V_{IN} < 6V$ for adjustable and 1.8V	0.463	0.600		V
Hysteresis	$V_{EN(HYS)}$	$2.9V < V_{IN} < 6V$ for 2.5V fixed output option. $2.2V < V_{IN} < 6V$ for adjustable and 1.8V		135		mV
Enable Pin Turn-On Delay	t_{EN}	$C_{OUT} = 10\mu F$, $I_{LOAD} = 1A$		150		μs
Enable Pin Leakage Current		$V_{IN} = 6V$, $EN = 3V$			1	μA
SOFT-START CHARACTERISTICS						
Reset Pull-Down Resistance	RPD			323		Ω
Soft-Start Charge Current	ICHG		-7.0	-4.5	-2.0	μA
PG PIN CHARACTERISTICS						
V_{OUT} PG Flag Threshold			75	84	92	$\%V_{OUT}$
V_{OUT} PG Flag Hysteresis				4		%
PG Flag Low Voltage		$I_{SINK} = 500\mu A$		47	100	mV
PG Flag Leakage Current		$V_{IN} = 6V$, $PG = 6V$		0.05	1	μA

NOTES:

- Compliance to datasheet limits is assured by one or more methods: production test, characterization, and/or design.
- Dropout is defined by the difference in supply V_{IN} and V_{OUT} when the supply produces a 2% drop in V_{OUT} from its nominal value.
- Minimum cap of $10\mu F$ X5R/X7R on V_{IN} and V_{OUT} required for stability.
- If the current limit for inrush current is acceptable in the application, do not use this feature (leave the SS pin open). Use only when large bulk capacitance is required on V_{OUT} for the application.

Typical Operating Performance

Unless otherwise noted, $V_{IN} = 2.2V$, $V_{OUT} = 1.8V$, $C_{IN} = C_{OUT} = 10\mu F$, $T_J = +25^\circ C$, $I_L = 0A$.

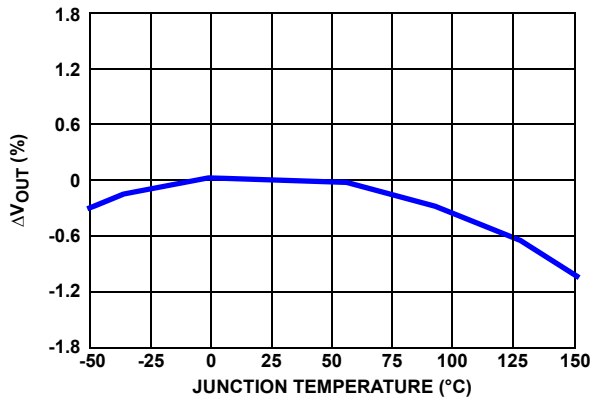

FIGURE 4. ΔV_{OUT} vs TEMPERATURE

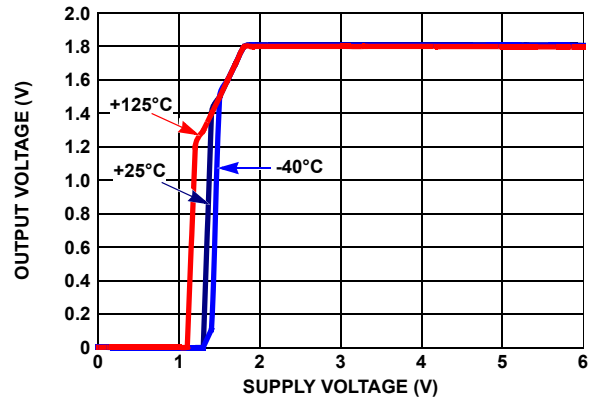

FIGURE 5. OUTPUT VOLTAGE vs SUPPLY VOLTAGE

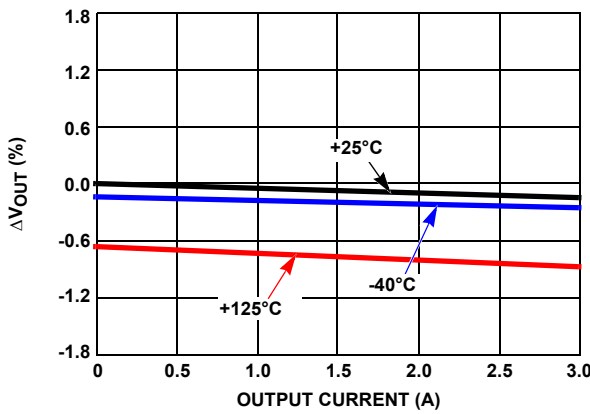

FIGURE 6. ΔV_{OUT} vs OUTPUT CURRENT

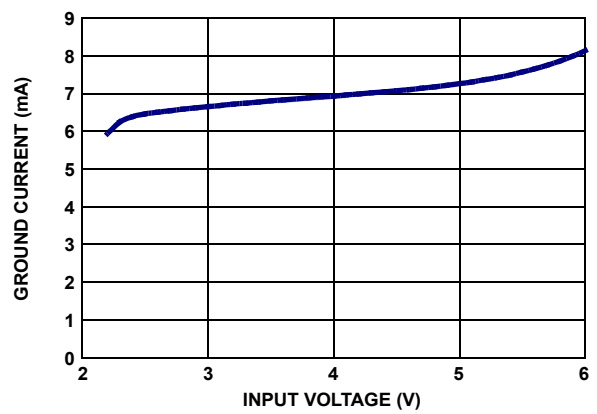

FIGURE 7. GROUND CURRENT vs SUPPLY VOLTAGE

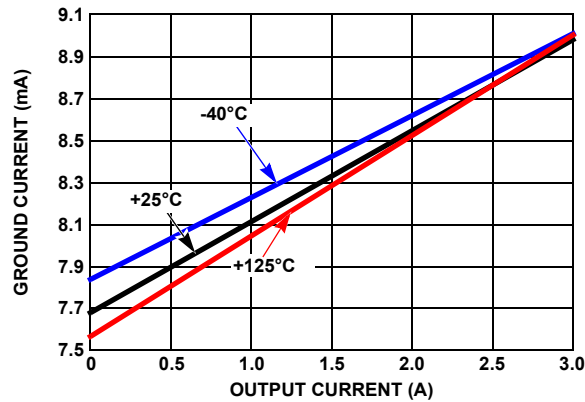

FIGURE 8. GROUND CURRENT vs OUTPUT CURRENT

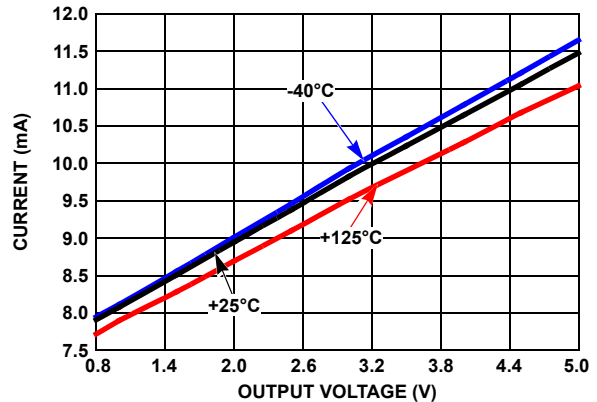

FIGURE 9. GROUND CURRENT vs OUTPUT VOLTAGE ($V_{IN} = V_{OUT} + V_{DO}$)

Typical Operating Performance

Unless otherwise noted, $V_{IN} = 2.2V$, $V_{OUT} = 1.8V$, $C_{IN} = C_{OUT} = 10\mu F$, $T_J = +25^\circ C$, $I_L = 0A$. (Continued)

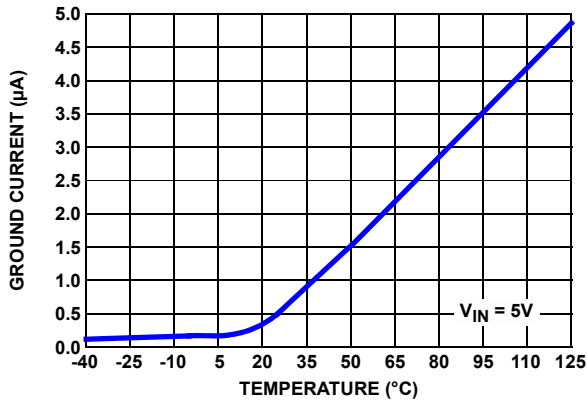

FIGURE 10. GROUND CURRENT IN SHUTDOWN vs TEMPERATURE

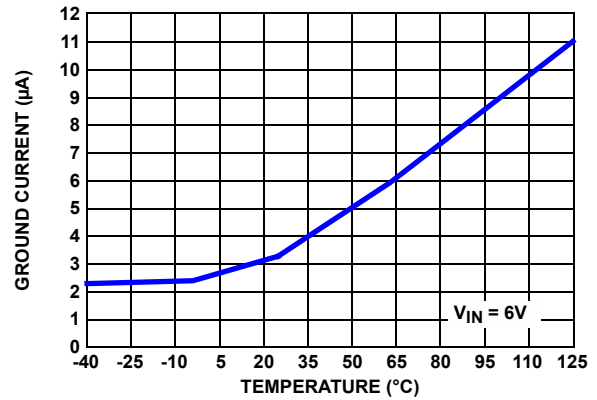

FIGURE 11. GROUND CURRENT IN SHUTDOWN vs TEMPERATURE

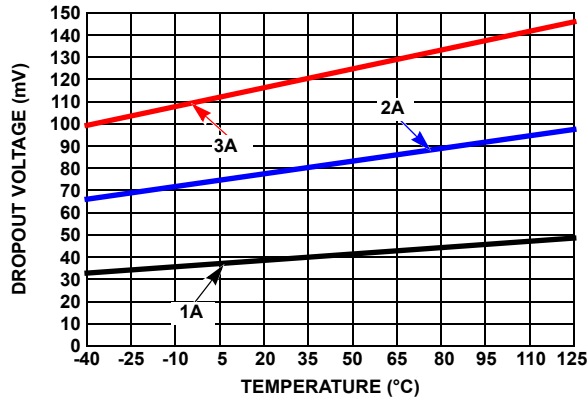

FIGURE 12. DROPOUT VOLTAGE vs TEMPERATURE

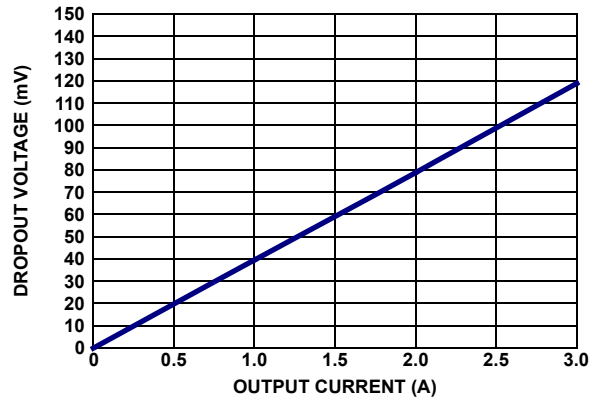

FIGURE 13. DROPOUT VOLTAGE vs OUTPUT CURRENT

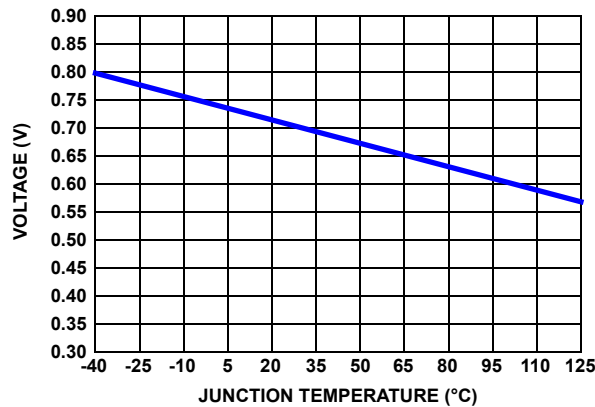

FIGURE 14. ENABLE THRESHOLD VOLTAGE vs TEMPERATURE

Typical Operating Performance

Unless otherwise noted, $V_{IN} = 2.2V$, $V_{OUT} = 1.8V$, $C_{IN} = C_{OUT} = 10\mu F$, $T_J = +25^\circ C$, $I_L = 0A$. (Continued)

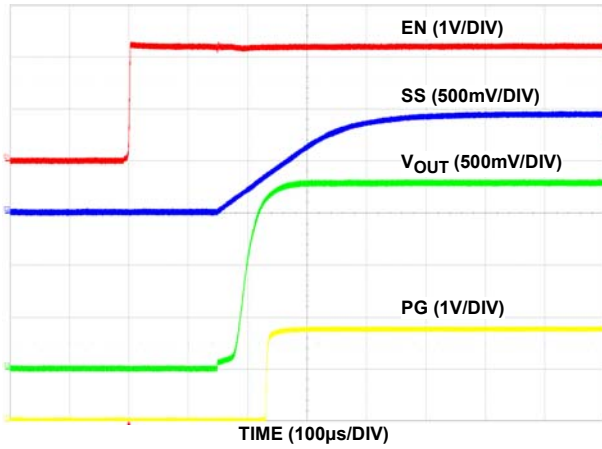

FIGURE 15. ENABLE START-UP SS CAP 1nF

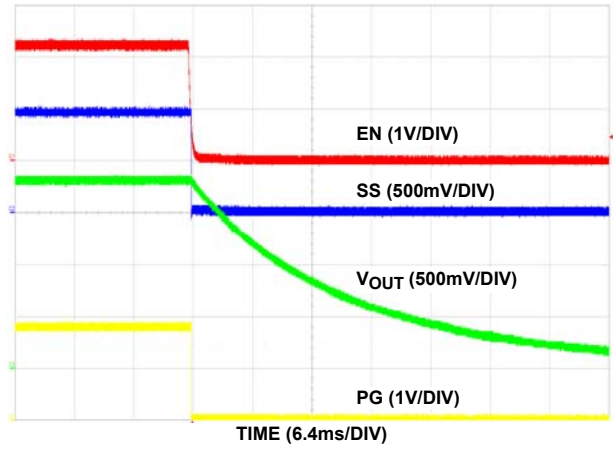

FIGURE 16. ENABLE SHUTDOWN SS CAP 1nF

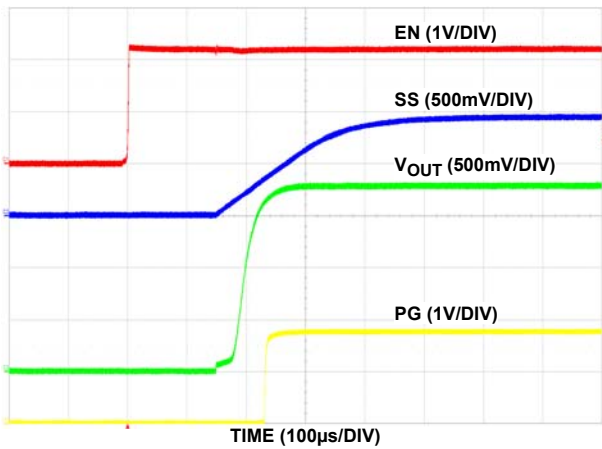

FIGURE 17. ENABLE START-UP SS CAP 100nF

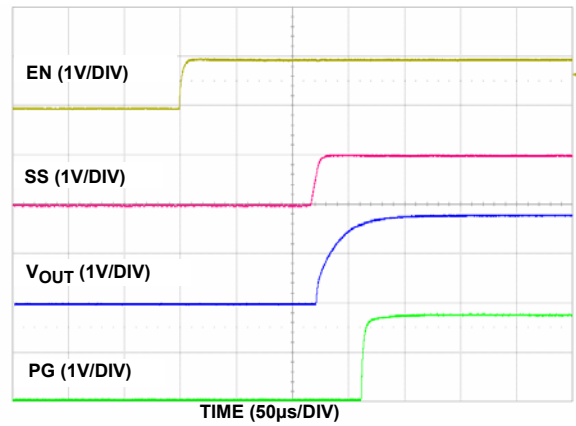

FIGURE 18. ENABLE START-UP (NO SS CAP)

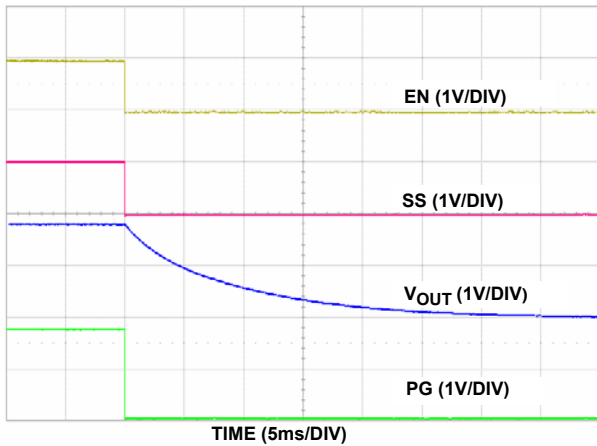

FIGURE 19. ENABLE SHUTDOWN (NO SS CAP)

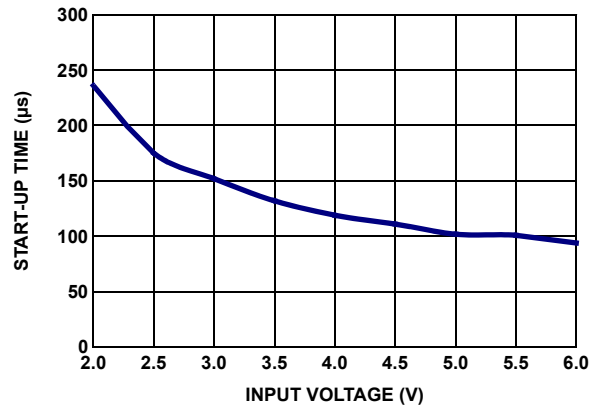

FIGURE 20. START-UP TIME vs SUPPLY VOLTAGE

Typical Operating Performance

$I_L = 0A$. (Continued)

Unless otherwise noted, $V_{IN} = 2.2V$, $V_{OUT} = 1.8V$, $C_{IN} = C_{OUT} = 10\mu F$, $T_J = +25^\circ C$,

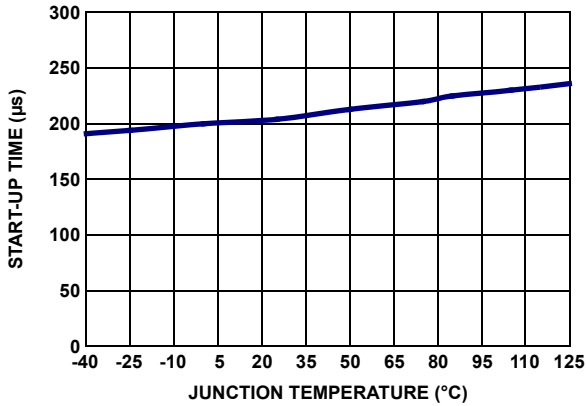

FIGURE 21. START-UP TIME vs TEMPERATURE

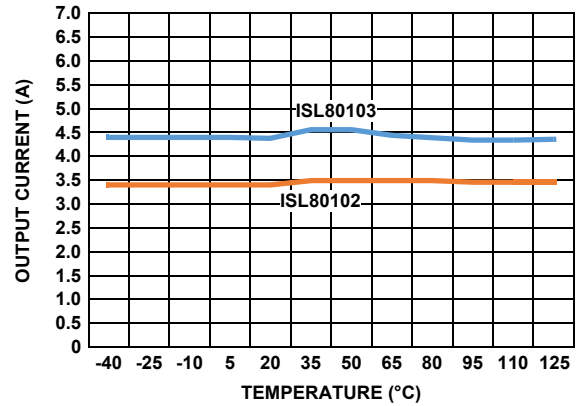

FIGURE 22. CURRENT LIMIT vs TEMPERATURE

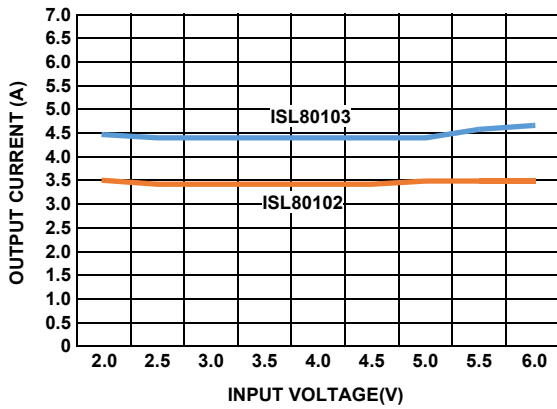

FIGURE 23. CURRENT LIMIT vs SUPPLY VOLTAGE

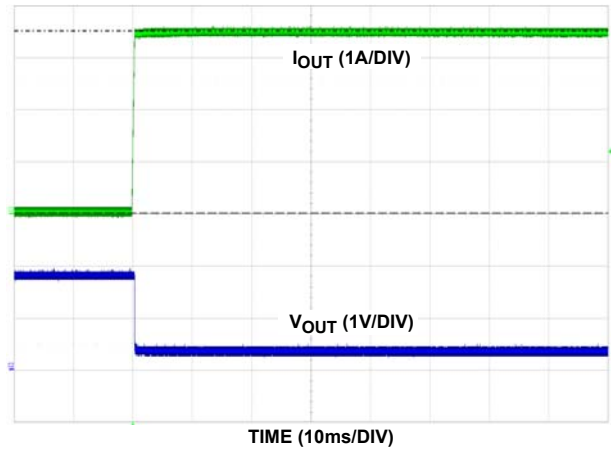

FIGURE 24. CURRENT LIMIT RESPONSE (ISL80102)

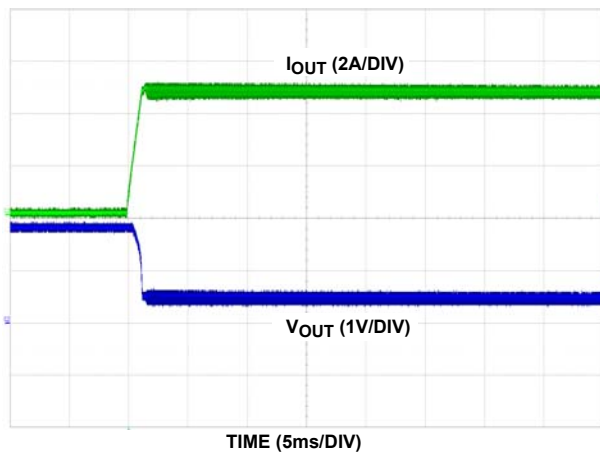

FIGURE 25. CURRENT LIMIT RESPONSE (ISL80103)

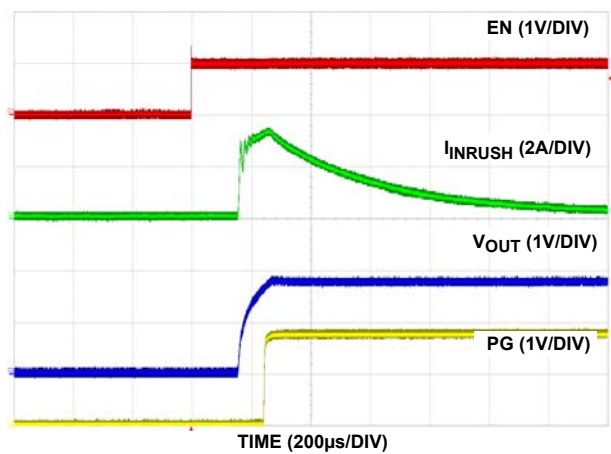

FIGURE 26. INRUSH CURRENT WITH NO SOFT-START CAPACITOR, $C_{OUT} = 1000\mu F$

Typical Operating Performance

Unless otherwise noted, $V_{IN} = 2.2V$, $V_{OUT} = 1.8V$, $C_{IN} = C_{OUT} = 10\mu F$, $T_J = +25^\circ C$, $I_L = 0A$. (Continued)

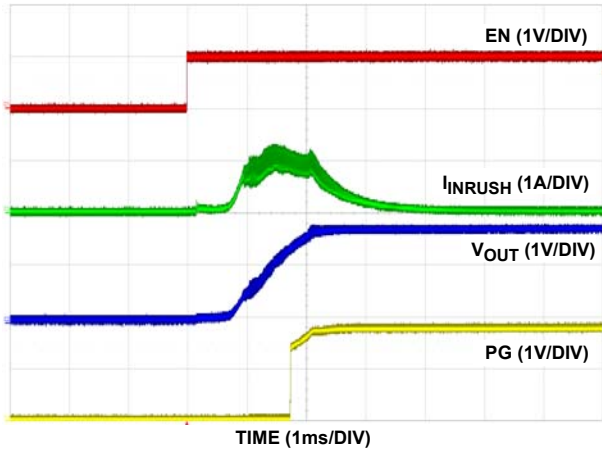

FIGURE 27. INRUSH WITH 22nF SOFT-START CAPACITOR, $C_{OUT} = 1000\mu F$

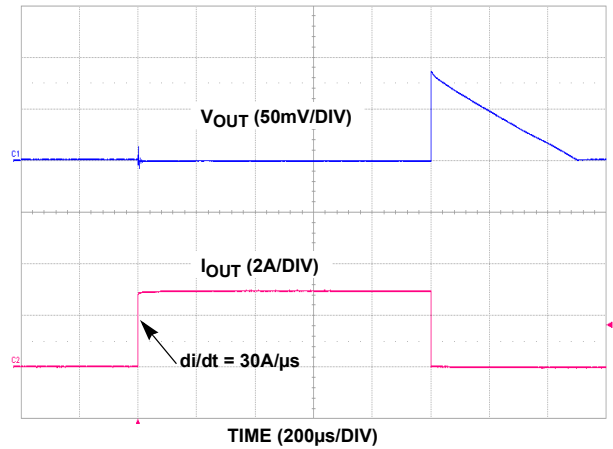

FIGURE 28. LOAD TRANSIENT 0A TO 3A, $C_{OUT} = 10\mu F$ CERAMIC

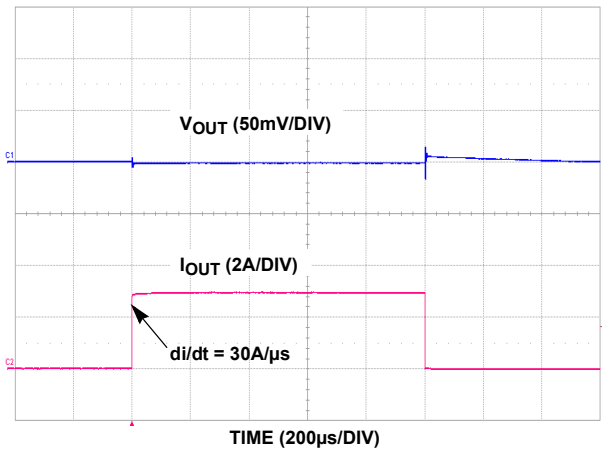

FIGURE 29. LOAD TRANSIENT 0A TO 3A, $C_{OUT} = 10\mu F$ CERAMIC + 100μF OSCON

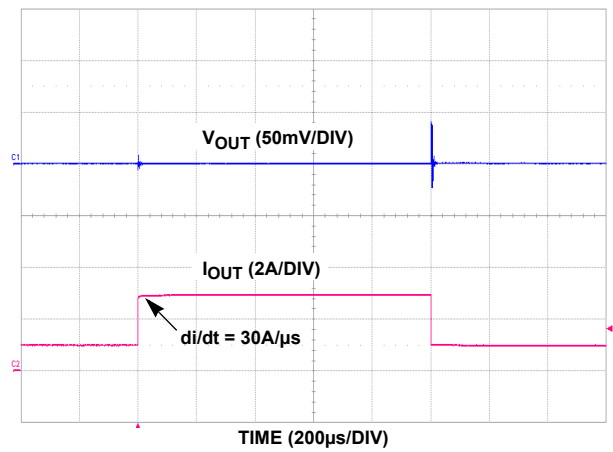

FIGURE 30. LOAD TRANSIENT 1A TO 3A, $C_{OUT} = 10\mu F$ CERAMIC

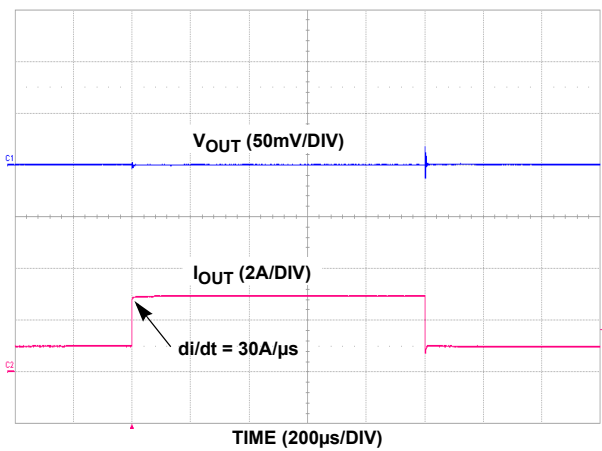

FIGURE 31. LOAD TRANSIENT 1A TO 3A, $C_{OUT} = 10\mu F$ CERAMIC + 100μF OSCON

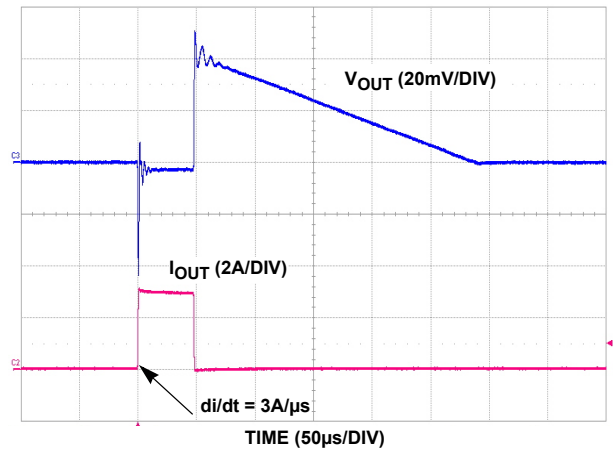

FIGURE 32. LOAD TRANSIENT 0A TO 3A, $C_{OUT} = 10\mu F$ CERAMIC, NO C_{PB} (ADJ VERSION)

Typical Operating Performance

Unless otherwise noted, $V_{IN} = 2.2V$, $V_{OUT} = 1.8V$, $C_{IN} = C_{OUT} = 10\mu F$, $T_J = +25^\circ C$, $I_L = 0A$. (Continued)

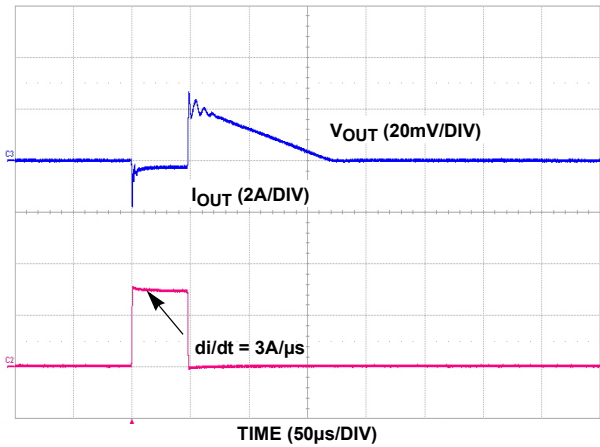

FIGURE 33. LOAD TRANSIENT 0A TO 3A, $C_{OUT} = 10\mu F$ CERAMIC, $C_{PB} = 1500pF$ (ADJ VERSION)

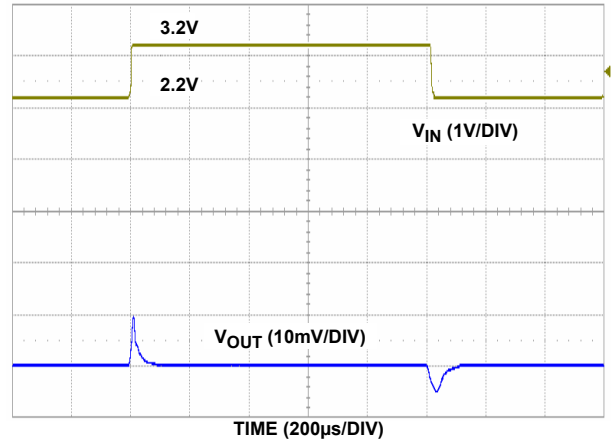

FIGURE 34. LINE TRANSIENT

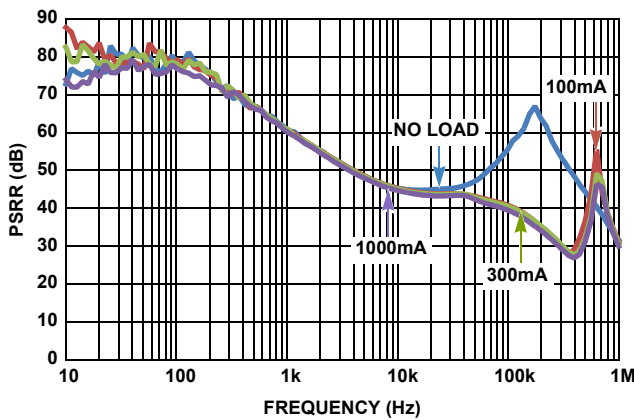

FIGURE 35. PSRR vs FREQUENCY FOR $V_{OUT} = 1.0V$, $V_{IN} = 2.5V$; $C_{OUT} = 47\mu F$, $C_{PB} = 150pF$

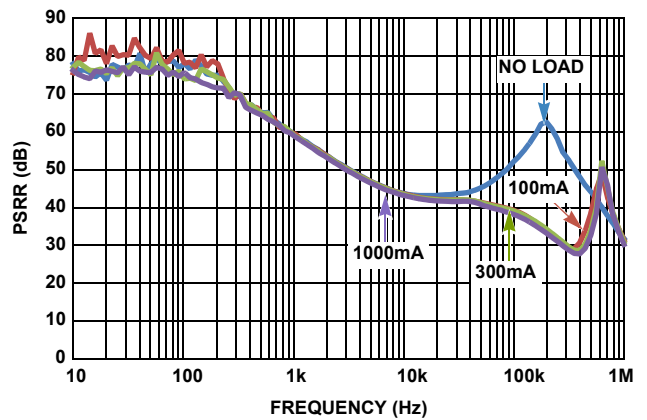

FIGURE 36. PSRR vs FREQUENCY FOR $V_{OUT} = 1.2V$; $V_{IN} = 2.5V$; $C_{OUT} = 47\mu F$, $C_{PB} = 150pF$

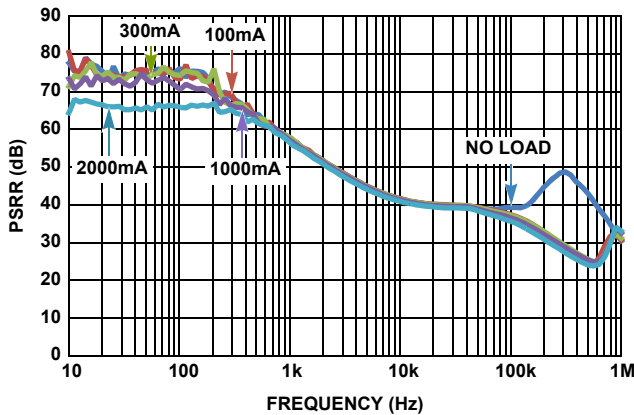

FIGURE 37. PSRR vs FREQUENCY FOR $V_{OUT} = 1.5V$, $V_{IN} = 2.5V$; $C_{OUT} = 22\mu F$, $C_{PB} = 82pF$

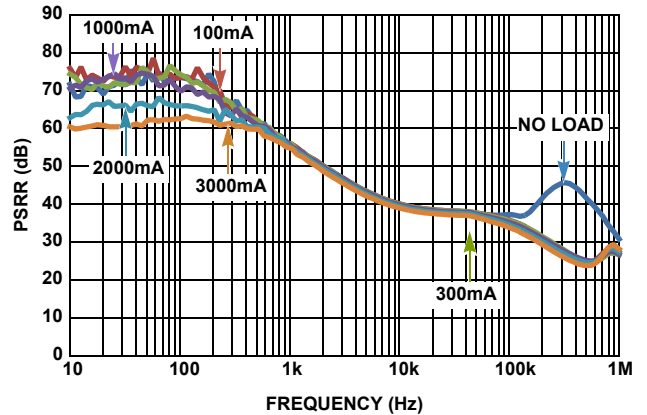

FIGURE 38. PSRR vs FREQUENCY FOR $V_{OUT} = 1.8V$, $V_{IN} = 2.5V$; $C_{OUT} = 22\mu F$, $C_{PB} = 82pF$

Typical Operating Performance

Unless otherwise noted, $V_{IN} = 2.2V$, $V_{OUT} = 1.8V$, $C_{IN} = C_{OUT} = 10\mu F$, $T_J = +25^\circ C$, $I_L = 0A$. (Continued)

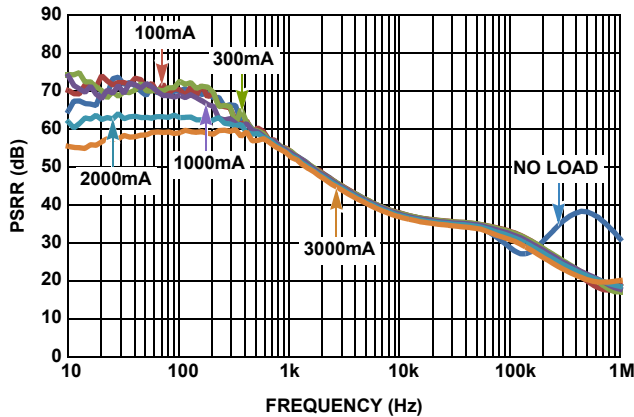

FIGURE 39. PSRR vs FREQUENCY FOR $V_{OUT} = 2.5V$, $V_{IN} = 3.3V$; $C_{OUT} = 10\mu F$, $C_{PB} = 47pF$

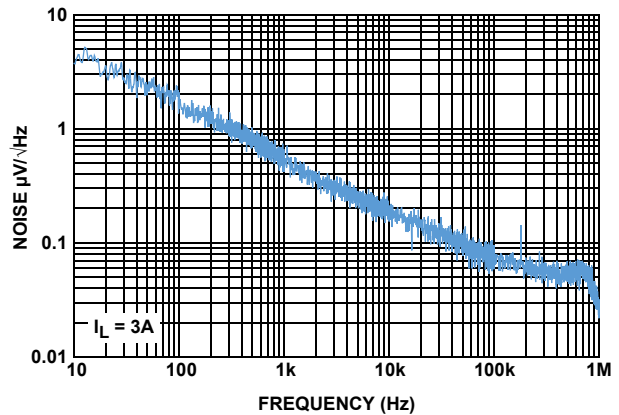

FIGURE 40. SPECTRAL NOISE DENSITY vs FREQUENCY

Functional Description

Input Voltage Requirements

Despite other output voltages offered, this family of LDOs is optimized for a true 2.5V to 1.8V conversion in which the input supply can have a tolerance of as much as $\pm 10\%$ for conditions noted in the “Electrical Specifications” table on [page 4](#). The minimum guaranteed input voltage is 2.2V; however, due to the nature of an LDO, V_{IN} must be some margin higher than the output voltage plus dropout at the maximum rated current of the application if active filtering (PSRR) is expected from V_{IN} to V_{OUT} . The dropout of this family of LDOs has been generously specified to allow applications to design for a level of efficiency that can accommodate the smaller outline package.

Enable Operation

The Enable turn-on threshold is typically 800mV with a hysteresis of 135mV. An internal pull-up or pull-down resistor is available upon request. As a result, this pin must not be left floating. This pin must be tied to V_{IN} if it is not used. A 1k Ω to 10k Ω pull-up resistor is required for applications that use open collector or open drain outputs to control the Enable pin. The Enable pin can be connected directly to V_{IN} for applications that are always on.

Power-Good Operation

Applications not using the power-good (PGOOD) feature must connect this pin to ground. The PGOOD flag is an open-drain NMOS that can sink up to 10mA during a fault condition. The PGOOD pin requires an external pull-up resistor, which is typically connected to the V_{OUT} pin. The PGOOD pin should not be pulled up to a voltage source greater than V_{IN} . PGOOD faults can be caused by the output voltage going below 84% of the nominal output voltage, or the current limit fault, or low input voltage. PGOOD does not function during thermal shutdown.

Soft-Start Operation (Optional)

If the current limit for inrush current is acceptable in the application, do not use the soft-start (SS) feature (leave the SS pin open). The soft-start circuit controls the rate at which the output voltage comes up to regulation at power-up or LDO enable. The external soft-start capacitor always gets discharged to ground pin potential at the beginning of start-up or enabling. After the capacitor discharges, it will immediately begin charging by a constant current source. The discharge rate is the RC time constant of R_{PD} and C_{SS} . Refer to [Figures 15](#) through [19](#) in the “Typical Operating Performance Curves” beginning on [page 8](#). R_{PD} is the ON-resistance of the pull-down MOSFET, M8. R_{PD} is typically 323 Ω .

The soft-start feature effectively reduces the inrush current at power-up or LDO enable until V_{OUT} reaches regulation. The in-rush current can be an issue for applications that require large, external bulk capacitances on V_{OUT} where high levels of charging current can be seen for a significant period of time. The inrush currents can cause V_{IN} to drop below minimum which could cause V_{OUT} to shutdown. [Figure 27 on page 10](#) shows the relationship between inrush current and C_{SS} with a C_{OUT} of 1000 μF .

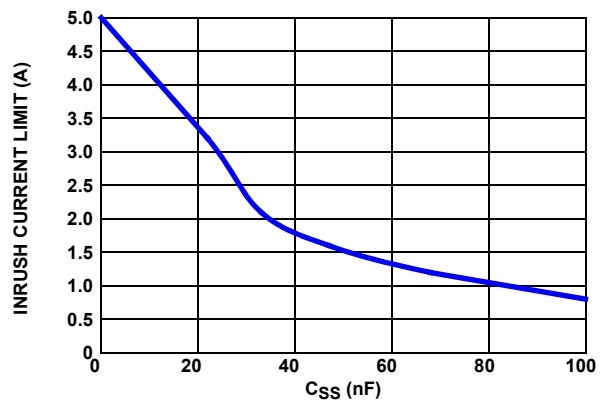

FIGURE 41. INRUSH CURRENT vs SOFT-START CAPACITANCE

Output Voltage Selection

An external resistor divider scales the output voltage relative to the internal reference voltage. This voltage is then fed back to the error amplifier. The output voltage can be programmed to any level between 0.8V and 5.5V. An external resistor divider, R_3 and R_4 , sets the output voltage as shown in [Equation 1](#). The recommended value for R_4 is 200Ω to 5kΩ. R_3 is then chosen according to [Equation 2](#):

$$V_{OUT} = 0.5V \times \left(\frac{R_3}{R_4} + 1 \right) \quad (\text{EQ. 1})$$

$$R_3 = R_4 \times \left(\frac{V_{OUT}}{0.5V} - 1 \right) \quad (\text{EQ. 2})$$

External Capacitor Requirements

External capacitors are required for proper operation. To ensure optimal performance, pay careful attention to the layout guidelines and selection of capacitor type and value.

OUTPUT CAPACITOR

The ISL80102 and ISL80103 apply state-of-the-art internal compensation to keep selection of the output capacitor simple for the customer. Stable operation over full temperature, V_{IN} range, V_{OUT} range, and load extremes are guaranteed for all ceramic capacitors and values assuming a 10μF X5R/X7R is used for local bypass on V_{OUT} . This minimum capacitor (see [Table 1 on page 2](#) for component value selections) must be connected to the V_{OUT} and ground pins of the LDO with PCB traces no longer than 0.5cm.

Lower cost Y5V and Z5U type ceramic capacitors are acceptable if the size of the capacitor is large enough to compensate for the significantly lower tolerance over X5R/X7R types. Additional capacitors of any value in Ceramic, POSCAP, or Alum/Tantalum Electrolytic types can be placed in parallel to improve PSRR at higher frequencies and/or load transient AC output voltage tolerances.

INPUT CAPACITOR

The minimum input capacitor required for proper operation is a 10μF with a ceramic dielectric. This minimum capacitor must be connected to V_{IN} and ground pins of the LDO with PCB traces no longer than 0.5cm.

Phase Boost Capacitor (Optional)

The ISL80102 and ISL80103 are designed to be stable with 10μF or larger ceramic capacitors.

Applications using the ADJ versions may see improved performance with the addition of a small ceramic capacitor C_{PB} as shown in [Figure 2 on page 2](#). The conditions in which C_{PB} may be beneficial are:

- $V_{OUT} > 1.5V$
- $C_{OUT} = 10\mu F$
- Tight AC voltage regulation band

C_{PB} introduces phase lead with the product of R_3 and C_{PB} that results in increasing the bandwidth of the LDO. Typical $R_3 \times C_{PB}$ should be less than 0.4μs (400ns).

Current Limit Protection

The ISL80102 and ISL80103 family of LDOs incorporates protection against overcurrent due to a short overload condition applied to the output and the inrush current that occurs at start-up. The LDO performs as a constant current source when the output current exceeds the current limit threshold noted in the “Electrical Specifications” table on [page 4](#). If the short or overload condition is removed from V_{OUT} , then the output returns to normal voltage mode regulation. In the event of an overload condition, the LDO may begin to cycle on and off due to the die temperature exceeding the thermal fault condition.

Power Dissipation and Thermals

The junction temperature must not exceed the range specified in the “Recommended Operating Conditions” on [page 4](#). The power dissipation can be calculated by using [Equation 3](#):

$$P_D = (V_{IN} - V_{OUT}) \times I_{OUT} + V_{IN} \times I_{GND} \quad (\text{EQ. 3})$$

The maximum allowable junction temperature, $T_{J(MAX)}$ and the maximum expected ambient temperature, $T_{A(MAX)}$ will determine the maximum allowable power dissipation as shown in [Equation 4](#):

$$P_{D(MAX)} = (T_{J(MAX)} - T_A) / \theta_{JA} \quad (\text{EQ. 4})$$

where θ_{JA} is the junction-to-ambient thermal resistance.

For safe operation, ensure that the power dissipation calculated in [Equation 3](#), P_D , is less than the maximum allowable power dissipation $P_{D(MAX)}$.

The DFN package uses the copper area on the PCB as a heatsink. The EPAD of this package must be soldered to the copper plane (GND plane) for heat sinking. [Figure 42](#) shows a curve for the θ_{JA} of the DFN package for different copper area sizes.

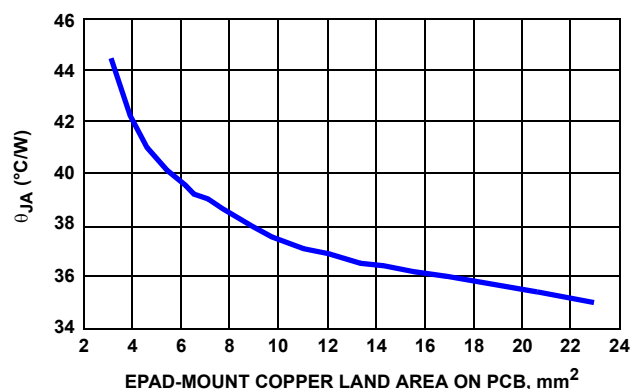

FIGURE 42. 3mmx3mm-10 PIN DFN ON 4-LAYER PCB WITH THERMAL VIAS θ_{JA} vs EPAD-MOUNT COPPER LAND AREA ON PCB

Thermal Fault Protection

If the die temperature exceeds typically +160°C, then the output of the LDO will shut down until the die temperature can cool down to typically +145°C. The level of power combined with the thermal impedance of the package (+48°C/W for DFN) will determine if the junction temperature exceeds the thermal shutdown temperature.

Revision History

The revision history provided is for informational purposes only and is believed to be accurate, but not warranted. Please go to web to make sure you have the latest Rev.

DATE	REVISION	CHANGE
Mar 19, 2018	FN6680.9	Added Related Literature section to page 1. Changed values in Output Voltage Selection section on page 13 from "500Ω to 1kΩ" to "200Ω to 5kΩ". Removed About Intersil section and added Renesas disclaimer.
Sep 2, 2016	FN6660.8	Removed Note 8 "Electromigration specification defined as lifetime average junction temperature of +110°C where max rated DC current = lifetime average current" from Recommended Operating Conditions.
Apr 8, 2016	FN6660.7	Updated Ordering Information table (on page 3), Note 1 to include quantities for tape and reel options. Changed VOUT range upper limit from "5V to 5.5V" on page 1, in the "Recommended Operating Conditions (Note 7)" on page 4 and in the "Output Voltage Selection" on page 12 Electrical Spec table test conditions changed from: $V_{IN} = V_{OUT} + 0.4V$, $V_{OUT} = 1.8V$, $C_{IN} = C_{OUT} = 10\mu F$, $T_J = +25^\circ C$, $I_{LOAD} = 0A$, to: $2.2V < V_{IN} < 6V$, $V_{OUT} = 0.5V$, $T_J = +25^\circ C$, $I_{LOAD} = 0A$ Changed Test conditions in "Output Noise Voltage" on page 5 from: $I_{LOAD} = 10mA$, $BW = 300Hz < f < 300kHz$; to: $V_{IN} = 2.2V$, $V_{OUT} = 1.8V$, $I_{LOAD} = 3A$, $BW = 100Hz < f < 100kHz$ and changed TYP from: 100; to: 49 Added two rows to "Dropout Voltage (Note 9)" on page 5 to show parameters for 5.5V V_{OUT} conditions. Updated verbiage for "About Intersil" on page 16. Updated POD L10.3x3 to most updated revision with changes as follows: Added missing dimension 0.415 in Typical Recommended land pattern. Shortened the e-pad rectangle on both the recommended land pattern and the package bottom view to line up with the centers of the corner pins. Changed Tiebar note 4, from: Tiebar shown (if present) is a non-functional feature. to: Tiebar shown (if present) is a non-functional feature and may be located on any of the 4 sides (or ends).
May 23, 2013	FN6660.6	Pin Descriptions on page 2, updated EPAD section From: EPAD at ground potential. Soldering it directly to GND plane is optional. To: EPAD must be connected to copper plane with as many vias as possible for proper electrical and optimal thermal performance. Removed obsolete part numbers: ISL80102IR33Z, ISL80102IR50Z, ISL80103IR33Z, ISL80103IR50Z from ordering information table on page 3. Added evaluation boards to ordering information table on page 3: ISL80103IR50Z and ISL80103EVAL2Z. Features on page 1: Removed 5 Ld TO220 and 5 Ld TO263. Input Voltage Requirements on page 12: Removed the sentence "those applications that cannot accommodate the profile of the TO220/TO263".
Jun 14, 2012	FN6660.5	In "Thermal Information" on page 4, corrected θ_{JA} from 48 to 45.
Feb 14, 2012	FN6660.4	Increased "VEN(HIGH)" minimum limit from 0.4V to 0.616 and added the "VEN(LOW)" spec for clarity on page 5.
Dec 14, 2011	FN6660.3	Increased "Turn-on Threshold" minimum limit on page 5 from 0.3V to 0.4V. Updated "Package Outline Drawing" on page 16 as follows: Removed package outline and included center to center distance between lands on recommended land pattern. Removed Note 4 "Dimension b applies to the metallized terminal and is measured between 0.18mm and 0.30mm from the terminal tip." since it is not applicable to this package. Renumbered notes accordingly.
Mar 4, 2011	FN6660.2	Converted to new template On page 1 - first paragraph, changed "Fixed output voltage options are available in 1.5V, 1.8V, 2.5V, 3.3V and 5V" to "Fixed output voltage options are available in 1.8V, 2.5V, 3.3V and 5V" In "Ordering Information" table on page 2, removed ISL80102IR15Z and ISL80103IR15Z. In Note 3 on page 2, below the "Ordering Information" table, removed '1.5V', so it reads "The 3.3V and 5V fixed output voltages will be released in the future. Please contact Intersil Marketing for more details."

Revision History

The revision history provided is for informational purposes only and is believed to be accurate, but not warranted. Please go to web to make sure you have the latest Rev. (Continued)

DATE	REVISION	CHANGE
Mar 4, 2010	FN6660.1	<p>Corrected Features on page 1 as follows:</p> <ul style="list-style-type: none"> -Changed bullet " • 185mV Dropout @ 3A, 125mV Dropout @ 2A" to " • Very Low 120mV Dropout at 3A" -Changed bullet " • 65dB Typical PSRR" to " • 62dB Typical PSRR" -Deleted 0.5% Initial VOUT Accuracy <p>Modified Figure 1 and placed as "TYPICAL APPLICATION" on page 1.</p> <p>Moved Pinout to page 3</p> <p>In "Block Diagram" on page 2, corrected resistor associated with M5 from R4 to R5</p> <p>Updated "Block Diagram" on page 2 as follows"</p> <ul style="list-style-type: none"> - Added M8 from SS to ground. <p>Updated Figure 1 on page 1 as follows:</p> <ul style="list-style-type: none"> -Corrected Pin 6 from SS to IRSET -Removed Note 11 callout "Minimum cap on VIN and VOUT required for stability." Added Note "*CSS is optional. See Note 12 on Page 5." and "*** CPB is optional. See "Functional Description" on page 12 for more information." Added "The 1.5V, 3.3V and 5V fixed output voltages will be released in the future." to Note 3 on page 2. In "Thermal Information" on page 4, updated Theta JA from 45 to 48. In "Soft-Start Operation (Optional)" on page 12: -Changed "The external capacitor always gets discharged to 0V at start-up of after coming out of a chip disable. "The external capacitor always gets discharged to ground pin potential at start-up or enabling." -Changed "The soft-start function effectively limits the amount of inrush current below the programmed current limit during start-up or an enable sequence to avoid an overcurrent fault condition." to "The soft-start feature effectively reduces the inrush current at power-up or LDO enable until VOUT reaches regulation." -Added "See Figures 25 through 27 in the "Typical Operating Performance Curves" beginning on page 6." -Added "RPD is the on resistance of the pull-down MOSFET, M8. RPD is 300Ω typically."
Mar 4, 2010		<p>Added "Phase Boost Capacitor (Optional)" on page 13.</p> <p>In "Typical Operating Performance" on page 11, revised figure "PSRR vs VIN" which had 3 curves with "SPECTRAL NOISE DENSITY vs FREQUENCY" which has one curve.</p> <p>Added "Figure 33. "LOAD TRANSIENT 0A TO 3A, C_{OUT} = 10μF CERAMIC, NO CPB (ADJ VERSION)" and "Figure 34. "LOAD TRANSIENT 0A TO 3A, C_{OUT} = 10μF CERAMIC, CPB = 1500pF (ADJ VERSION)"</p>
Sep 30, 2009	FN6660.0	Initial Release.

Package Outline Drawing

For the most recent package outline drawing, see [L10.3x3](#).

L10.3x3

10 LEAD DUAL FLAT PACKAGE (DFN)

Rev 11, 3/15

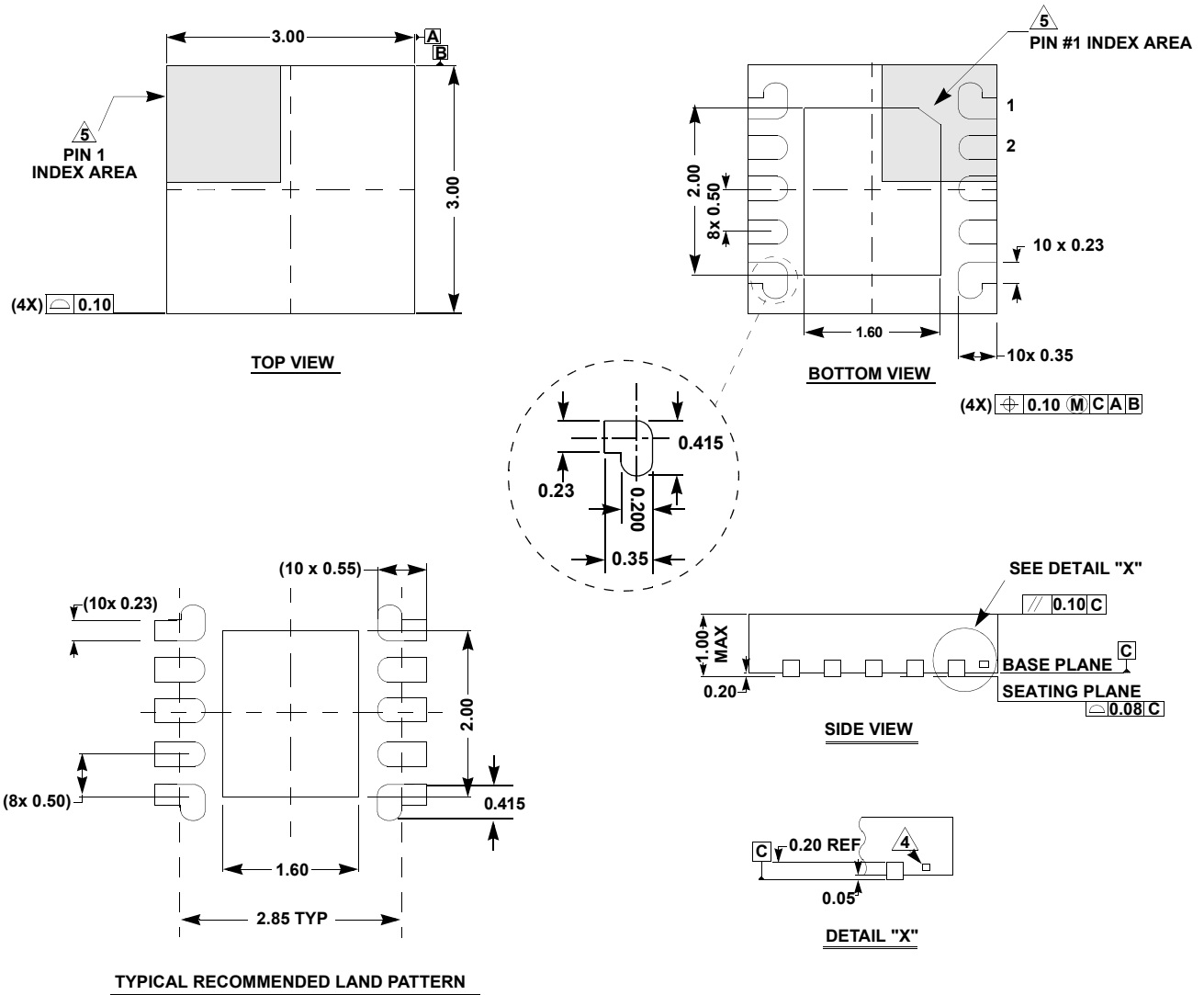

NOTES:

1. Dimensions are in millimeters.
Dimensions in () for Reference Only.
2. Dimensioning and tolerancing conform to ASME Y14.5m-1994.
3. Unless otherwise specified, tolerance : Decimal ± 0.05
4. Tiebar shown (if present) is a non-functional feature and may be located on any of the 4 sides (or ends).
5. The configuration of the pin #1 identifier is optional, but must be located within the zone indicated. The pin #1 identifier may be either a mold or mark feature.

Notice

1. Descriptions of circuits, software and other related information in this document are provided only to illustrate the operation of semiconductor products and application examples. You are fully responsible for the incorporation or any other use of the circuits, software, and information in the design of your product or system. Renesas Electronics disclaims any and all liability for any losses and damages incurred by you or third parties arising from the use of these circuits, software, or information.
2. Renesas Electronics hereby expressly disclaims any warranties against and liability for infringement or any other claims involving patents, copyrights, or other intellectual property rights of third parties, by or arising from the use of Renesas Electronics products or technical information described in this document, including but not limited to, the product data, drawings, charts, programs, algorithms, and application examples.
3. No license, express, implied or otherwise, is granted hereby under any patents, copyrights or other intellectual property rights of Renesas Electronics or others.
4. You shall not alter, modify, copy, or reverse engineer any Renesas Electronics product, whether in whole or in part. Renesas Electronics disclaims any and all liability for any losses or damages incurred by you or third parties arising from such alteration, modification, copying or reverse engineering.
5. Renesas Electronics products are classified according to the following two quality grades: "Standard" and "High Quality". The intended applications for each Renesas Electronics product depends on the product's quality grade, as indicated below.
"Standard": Computers; office equipment; communications equipment; test and measurement equipment; audio and visual equipment; home electronic appliances; machine tools; personal electronic equipment; industrial robots; etc.
"High Quality": Transportation equipment (automobiles, trains, ships, etc.); traffic control (traffic lights); large-scale communication equipment; key financial terminal systems; safety control equipment; etc.
Unless expressly designated as a high reliability product or a product for harsh environments in a Renesas Electronics data sheet or other Renesas Electronics document, Renesas Electronics products are not intended or authorized for use in products or systems that may pose a direct threat to human life or bodily injury (artificial life support devices or systems; surgical implantations; etc.), or may cause serious property damage (space system; undersea repeaters; nuclear power control systems; aircraft control systems; key plant systems; military equipment; etc.). Renesas Electronics disclaims any and all liability for any damages or losses incurred by you or any third parties arising from the use of any Renesas Electronics product that is inconsistent with any Renesas Electronics data sheet, user's manual or other Renesas Electronics document.
6. When using Renesas Electronics products, refer to the latest product information (data sheets, user's manuals, application notes, "General Notes for Handling and Using Semiconductor Devices" in the reliability handbook, etc.), and ensure that usage conditions are within the ranges specified by Renesas Electronics with respect to maximum ratings, operating power supply voltage range, heat dissipation characteristics, installation, etc. Renesas Electronics disclaims any and all liability for any malfunctions, failure or accident arising out of the use of Renesas Electronics products outside of such specified ranges.
7. Although Renesas Electronics endeavors to improve the quality and reliability of Renesas Electronics products, semiconductor products have specific characteristics, such as the occurrence of failure at a certain rate and malfunctions under certain use conditions. Unless designated as a high reliability product or a product for harsh environments in a Renesas Electronics data sheet or other Renesas Electronics document, Renesas Electronics products are not subject to radiation resistance design. You are responsible for implementing safety measures to guard against the possibility of bodily injury, injury or damage caused by fire, and/or danger to the public in the event of a failure or malfunction of Renesas Electronics products, such as safety design for hardware and software, including but not limited to redundancy, fire control and malfunction prevention, appropriate treatment for aging degradation or any other appropriate measures. Because the evaluation of microcomputer software alone is very difficult and impractical, you are responsible for evaluating the safety of the final products or systems manufactured by you.
8. Please contact a Renesas Electronics sales office for details as to environmental matters such as the environmental compatibility of each Renesas Electronics product. You are responsible for carefully and sufficiently investigating applicable laws and regulations that regulate the inclusion or use of controlled substances, including without limitation, the EU RoHS Directive, and using Renesas Electronics products in compliance with all these applicable laws and regulations. Renesas Electronics disclaims any and all liability for damages or losses occurring as a result of your noncompliance with applicable laws and regulations.
9. Renesas Electronics products and technologies shall not be used for or incorporated into any products or systems whose manufacture, use, or sale is prohibited under any applicable domestic or foreign laws or regulations. You shall comply with any applicable export control laws and regulations promulgated and administered by the governments of any countries asserting jurisdiction over the parties or transactions.
10. It is the responsibility of the buyer or distributor of Renesas Electronics products, or any other party who distributes, disposes of, or otherwise sells or transfers the product to a third party, to notify such third party in advance of the contents and conditions set forth in this document.
11. This document shall not be reprinted, reproduced or duplicated in any form, in whole or in part, without prior written consent of Renesas Electronics.
12. Please contact a Renesas Electronics sales office if you have any questions regarding the information contained in this document or Renesas Electronics products.
(Note 1) "Renesas Electronics" as used in this document means Renesas Electronics Corporation and also includes its directly or indirectly controlled subsidiaries.
(Note 2) "Renesas Electronics product(s)" means any product developed or manufactured by or for Renesas Electronics.

(Rev.4.0-1 November 2017)



SALES OFFICES

Renesas Electronics Corporation

<http://www.renesas.com>

Refer to "<http://www.renesas.com/>" for the latest and detailed information.

Renesas Electronics America Inc.

1001 Murphy Ranch Road, Milpitas, CA 95035, U.S.A.
Tel: +1-408-432-8888, Fax: +1-408-434-5351

Renesas Electronics Canada Limited

9251 Yonge Street, Suite 8309 Richmond Hill, Ontario Canada L4C 9T3
Tel: +1-905-237-2004

Renesas Electronics Europe Limited

Dukes Meadow, Millboard Road, Bourne End, Buckinghamshire, SL8 5FH, U.K
Tel: +44-1628-651-700, Fax: +44-1628-651-804

Renesas Electronics Europe GmbH

Arcadiastrasse 10, 40472 Düsseldorf, Germany
Tel: +49-211-6503-0, Fax: +49-211-6503-1327

Renesas Electronics (China) Co., Ltd.

Room 1709 Quantum Plaza, No.27 ZhichunLu, Haidian District, Beijing, 100191 P. R. China
Tel: +86-10-8235-1155, Fax: +86-10-8235-7679

Renesas Electronics (Shanghai) Co., Ltd.

Unit 301, Tower A, Central Towers, 555 Langao Road, Putuo District, Shanghai, 200333 P. R. China
Tel: +86-21-2226-0888, Fax: +86-21-2226-0999

Renesas Electronics Hong Kong Limited

Unit 1601-1611, 16/F., Tower 2, Grand Century Place, 193 Prince Edward Road West, Mongkok, Kowloon, Hong Kong
Tel: +852-2265-6688, Fax: +852 2886-9022

Renesas Electronics Taiwan Co., Ltd.

13F, No. 363, Fu Shing North Road, Taipei 10543, Taiwan
Tel: +886-2-8175-9600, Fax: +886 2-8175-9670

Renesas Electronics Singapore Pte. Ltd.

80 Bendemeer Road, Unit #06-02 Hyflux Innovation Centre, Singapore 339949
Tel: +65-6213-0200, Fax: +65-6213-0300

Renesas Electronics Malaysia Sdn.Bhd.

Unit 1207, Block B, Menara Amcorp, Amcorp Trade Centre, No. 18, Jln Persiaran Barat, 46050 Petaling Jaya, Selangor Darul Ehsan, Malaysia
Tel: +60-3-7955-9390, Fax: +60-3-7955-9510

Renesas Electronics India Pvt. Ltd.

No.777C, 100 Feet Road, HAL 2nd Stage, Indiranagar, Bangalore 560 038, India
Tel: +91-80-67208700, Fax: +91-80-67208777

Renesas Electronics Korea Co., Ltd.

17F, KAMCO Yangjae Tower, 262, Gangnam-daero, Gangnam-gu, Seoul, 06265 Korea
Tel: +82-2-558-3737, Fax: +82-2-558-5338