

LOC		DIST		REVISIONS			
P	LTN	DESCRIPTION	DATE	DWN	APVD		
B		REVISED PER ECR-16-001597	22JUL2016	BW	GJ		

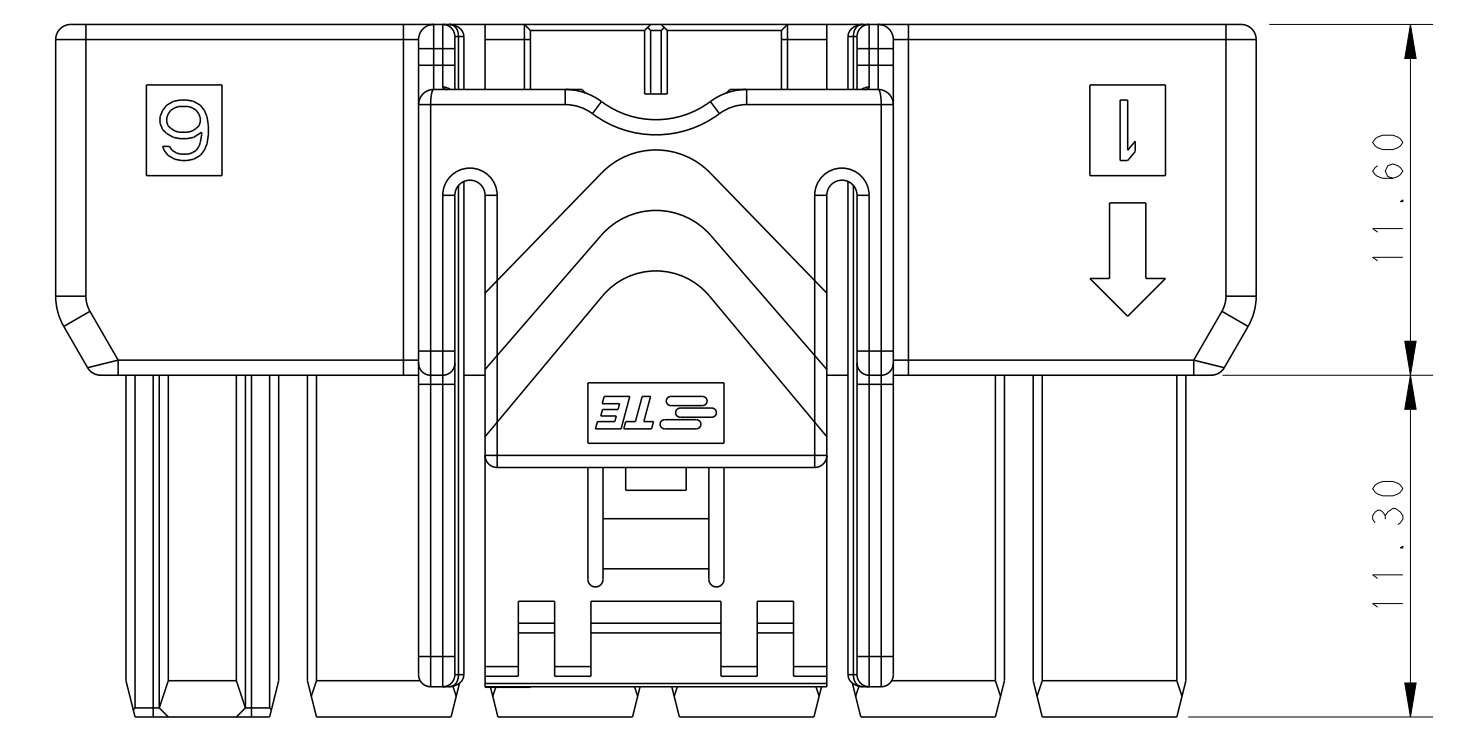

POS.	DIM. A
2*6	39.70
2*5	33.70
2*4	27.70
2*3	21.70

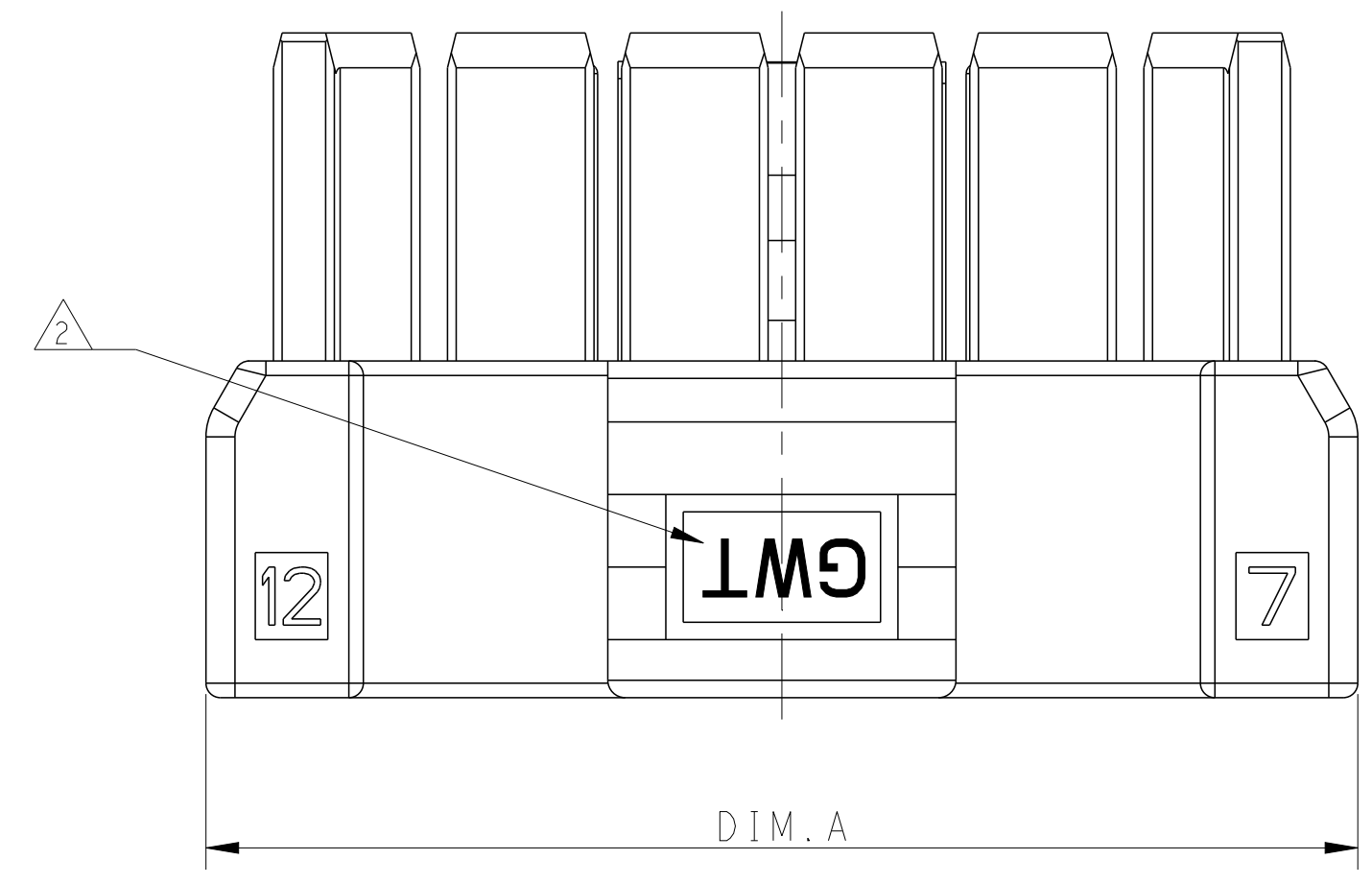
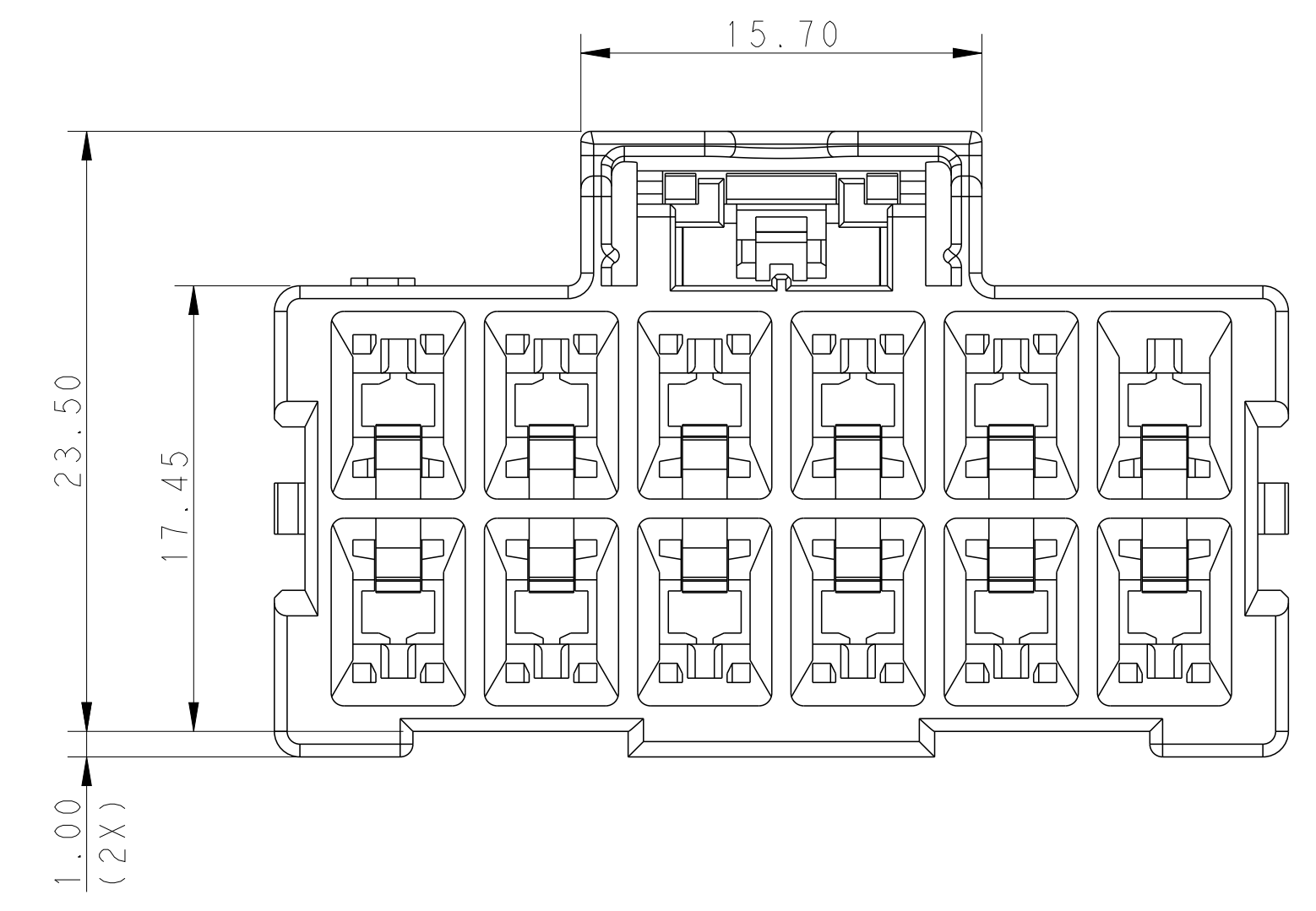
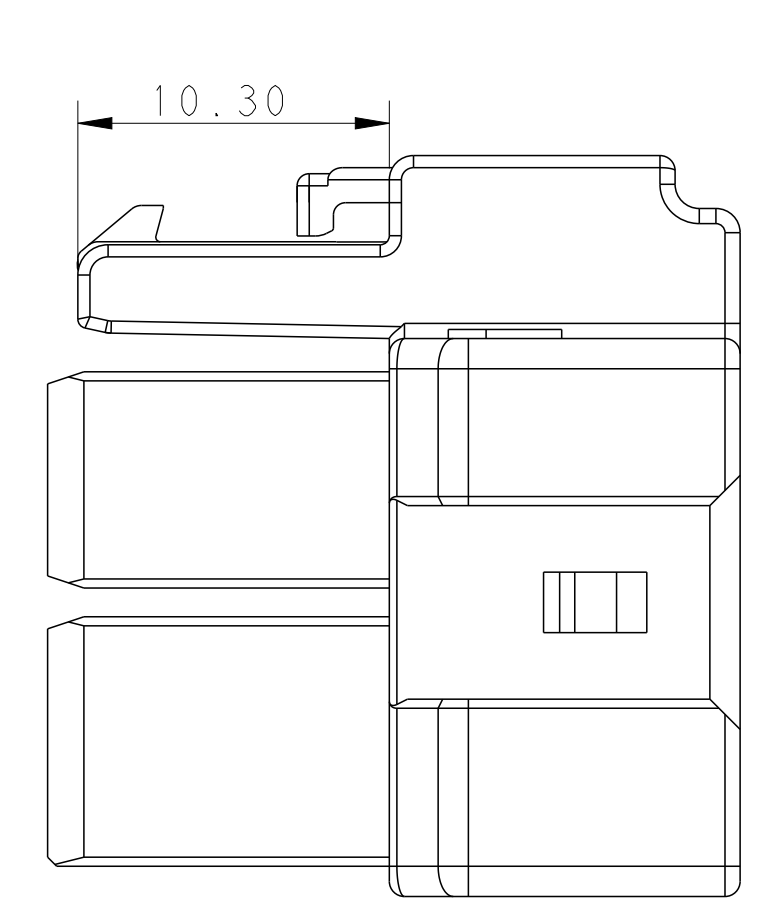
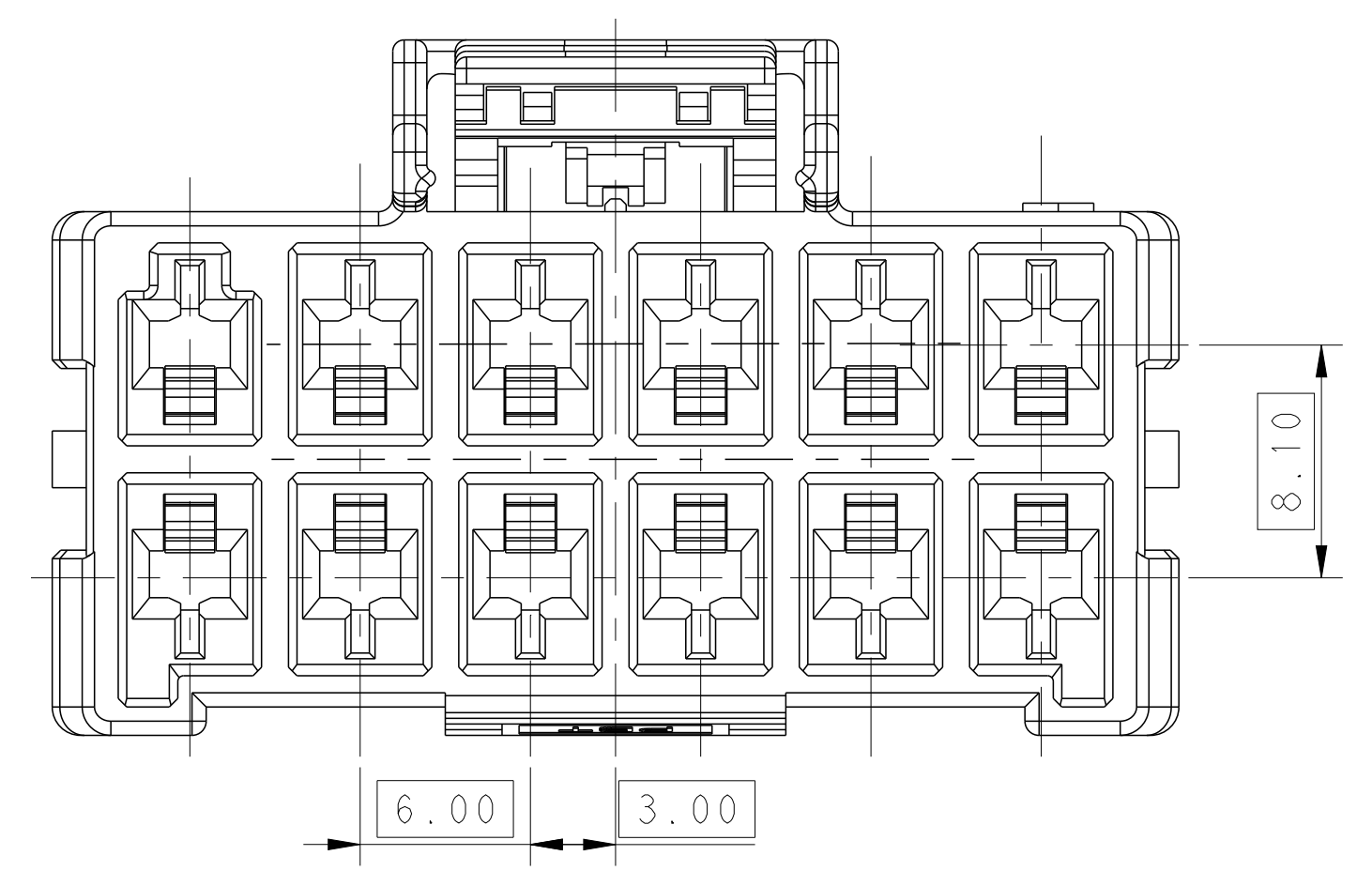

NOTE

- MATERIAL:
  - LEVEL A: PA6, COMPLY WITH GLOW WIRE REQUIREMENTS FOR PARTS OF NON-METALLIC MATERIAL SUPPORTING A CURRENT-CARRYING CONNECTION DETAILED IN IEC 60335-1, SECTION 30 (GWT), UL 94V-0
  - LEVEL B: PBT, HOT WIRE IGNITION (HWI) VERSION ARE MOLDED IN A RESIN THAT COMPLIES WITH TE HOT WIRE IGNITION TEST 109-32026 AND ARE RECOMMENDED FOR USE WITH HWI HOUSINGS THAT ALSO COMPLY, UL 94V-0

- MATERIAL MARK:
  - LEVEL A:GWT,LEVEL B:HWT

- APPLICABLE CONTACT P/N
  - RECEPTACLE CONTACT:1971237/1971779/81/83/85/87-\*,2238066-\*

- MATING CONN, P/N
  - CAP HSG: \*-2232359/264-\*
  - TPA: \*-1971778-\*

5. This product has not completed validation testing.

THIS DRAWING IS A CONTROLLED DOCUMENT.		DWG	TOMMY WU	26MAR2013	TE Connectivity PLUG HOUSING, DOUBLE ROW POWER TRIPLE LOCK		
DIMENSIONS:		CHK	HAPYE WU	26MAR2013			
mm		APVD	YIHONG MAO	26MAR2013			
TOLERANCES UNLESS OTHERWISE SPECIFIED:		NAME		SIZE	CAGE CODE	DRAWING NO	RESTRICTED TO
0 PLC	±	PRODUCT SPEC		A1	00779	C=2232266	
1 PLC	±0.35	APPLICATION SPEC					
2 PLC	±0.25	114-106118					
3 PLC	±	WEIGHT					
4 PLC	±	Customer Drawing					
ANGLES	±	SCALE					
FINISH	-	SHEET		1	OF	2	REV
		B					

LOC		DIST		REVISIONS			
P	LTN	DESCRIPTION	DATE	DNW	APVD		
-	-	SEE SHEET 1	-	-	-		

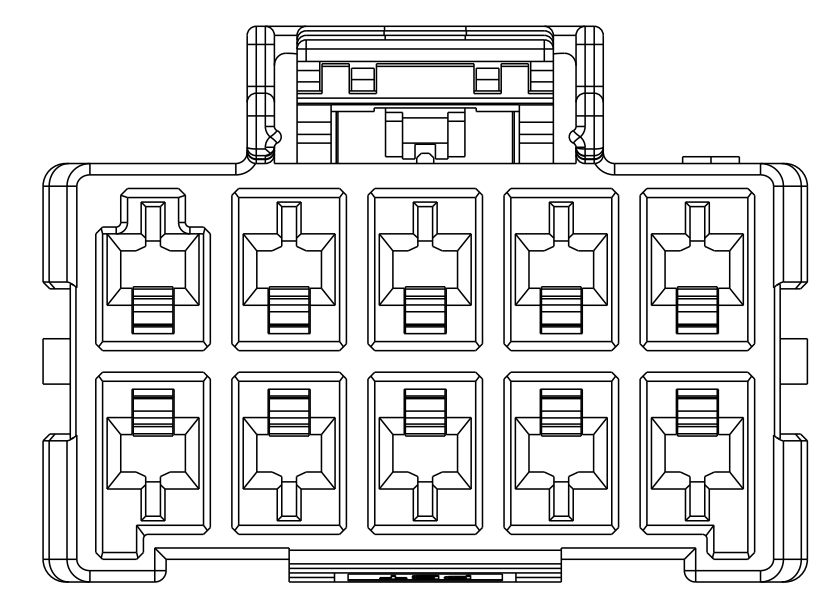
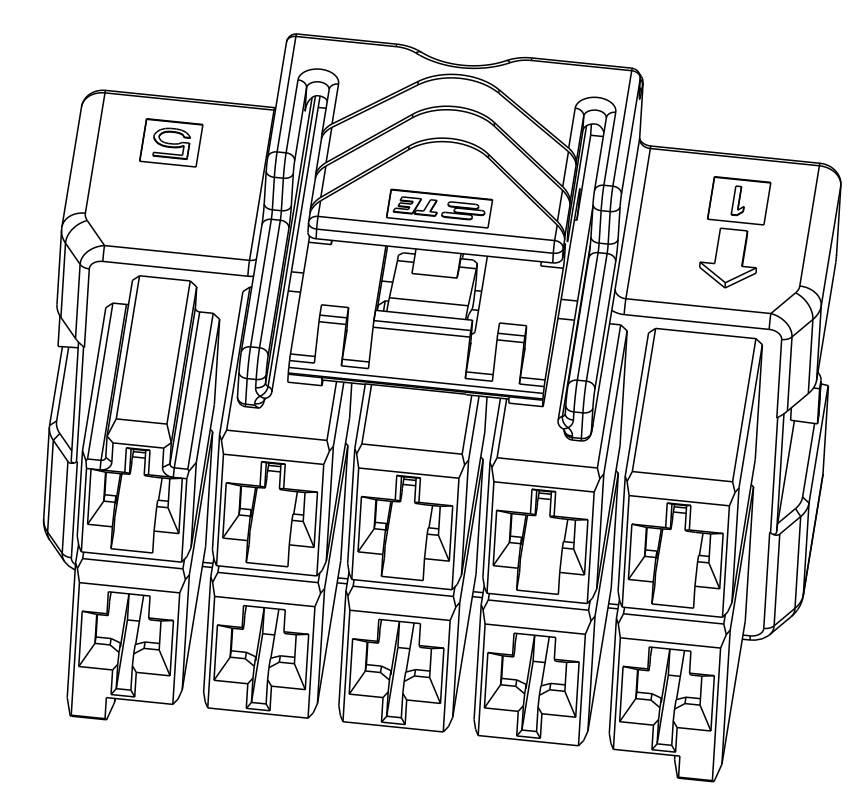

2\*5 POSITIONS

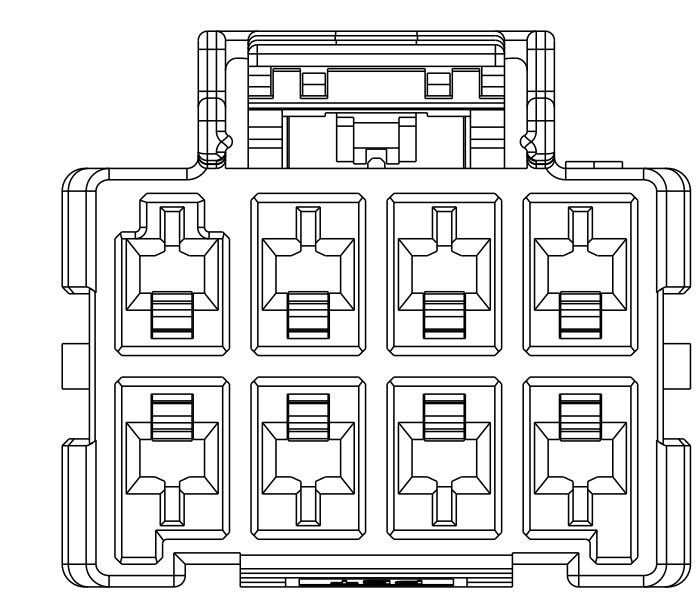
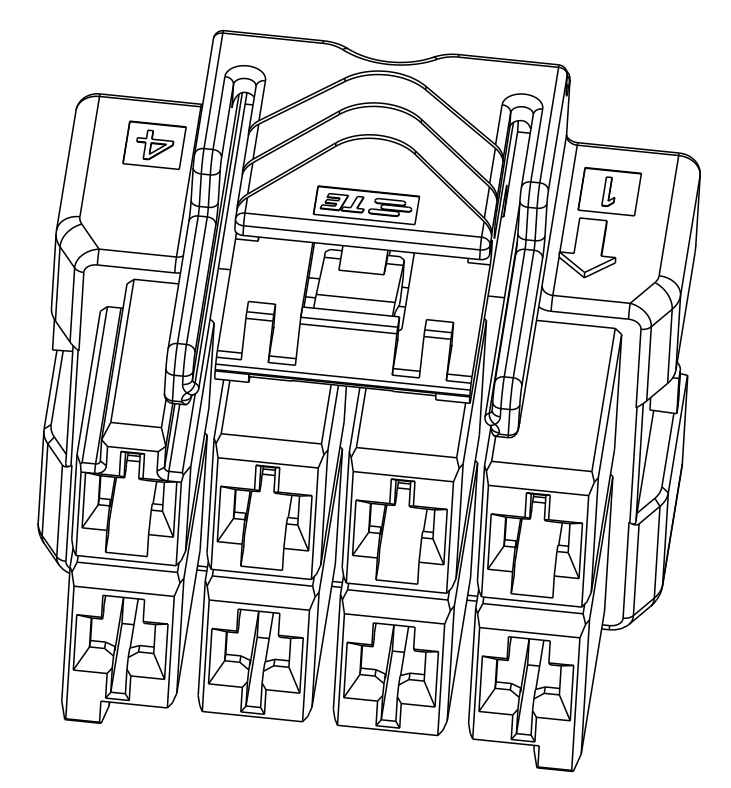

2\*4 POSITIONS

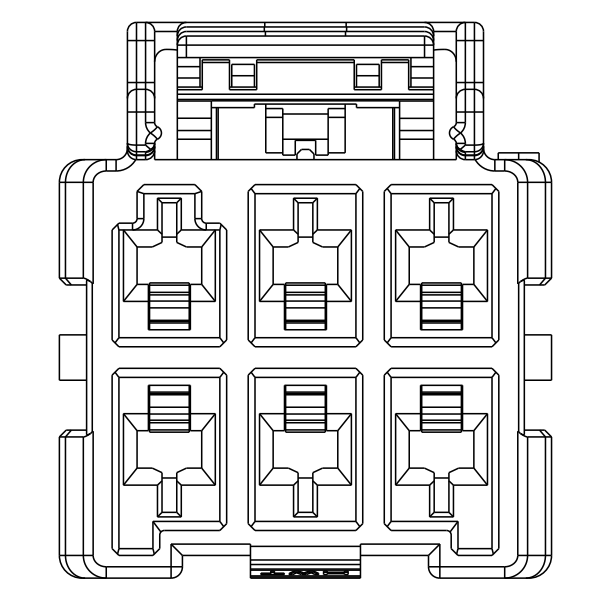
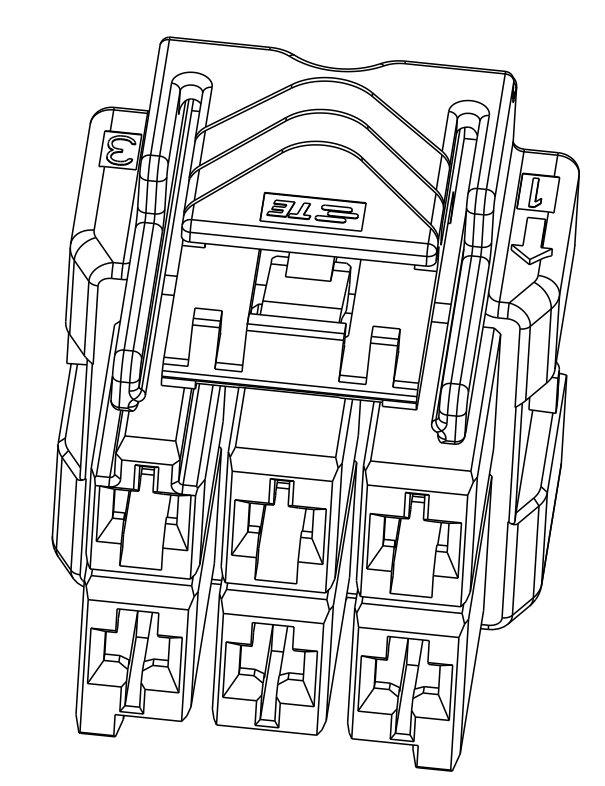

2\*3 POSITIONS

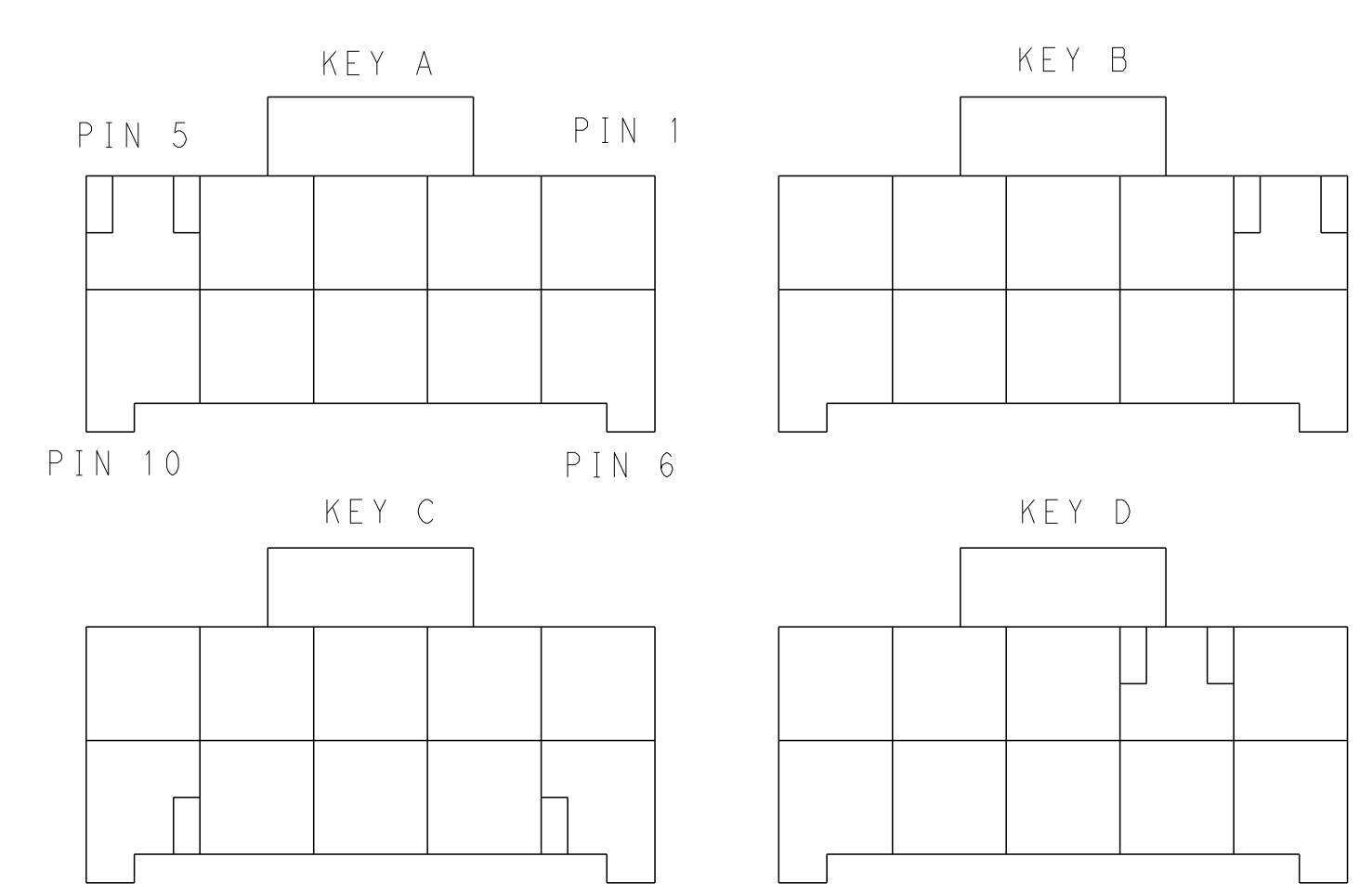

KEYING FOR 2\*5 POS.

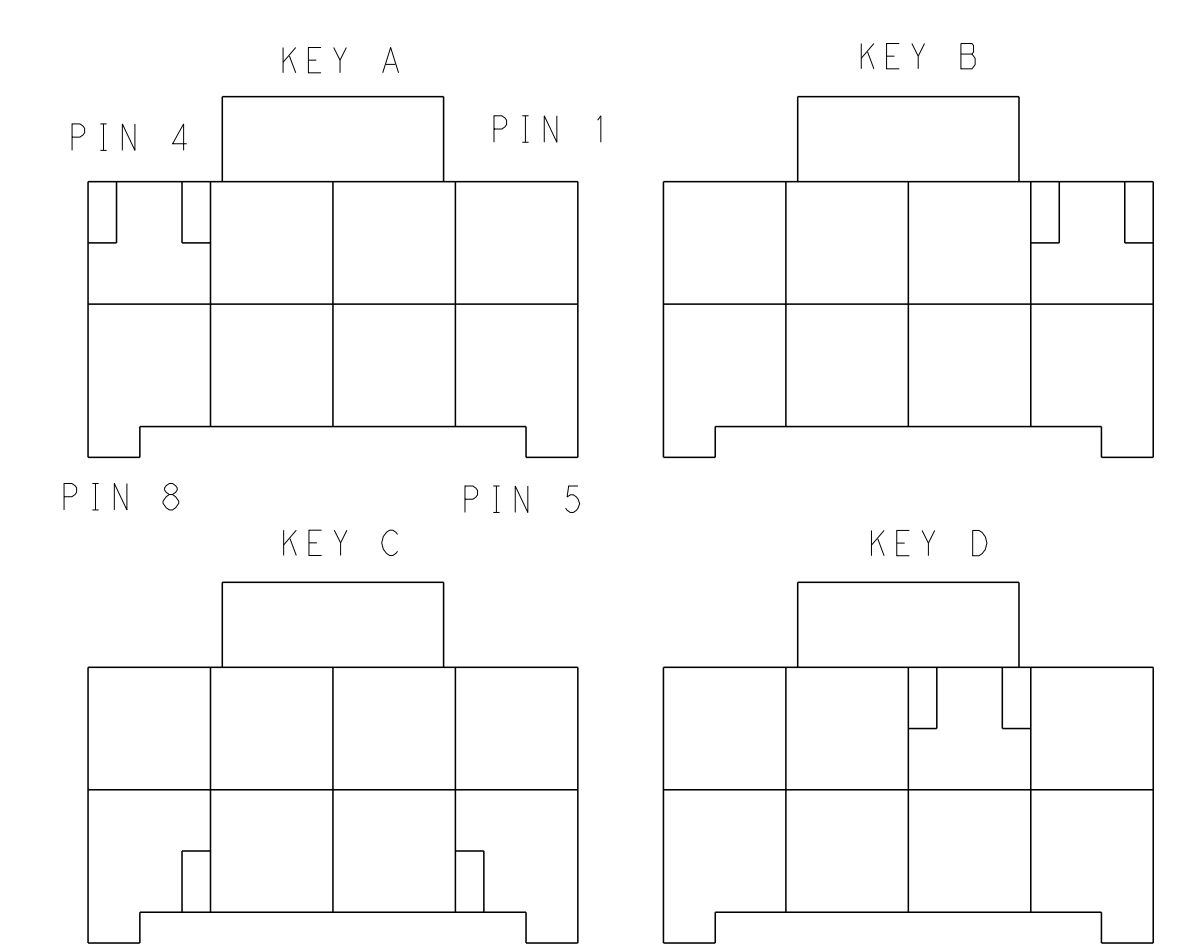

KEYING FOR 2\*4 POS.

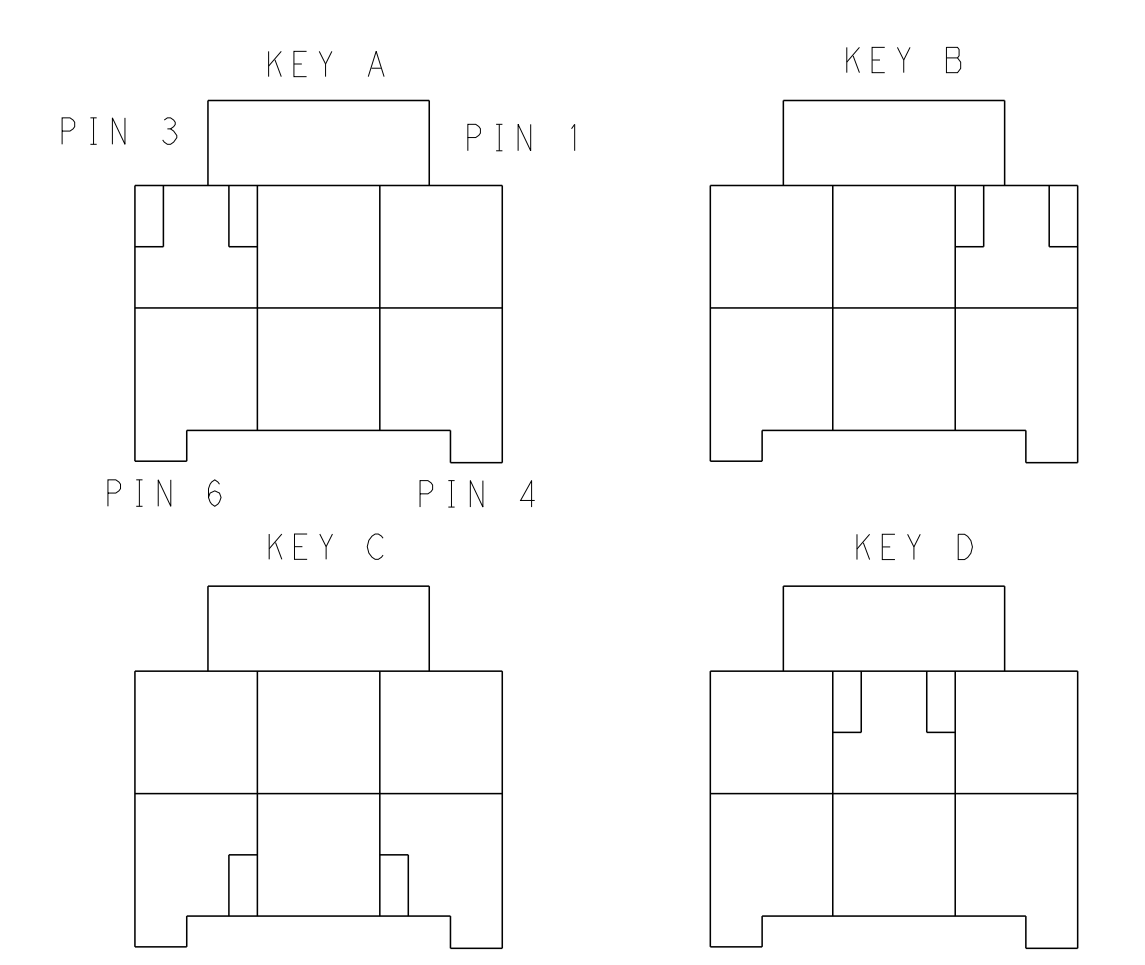

KEYING FOR 2\*3 POS.

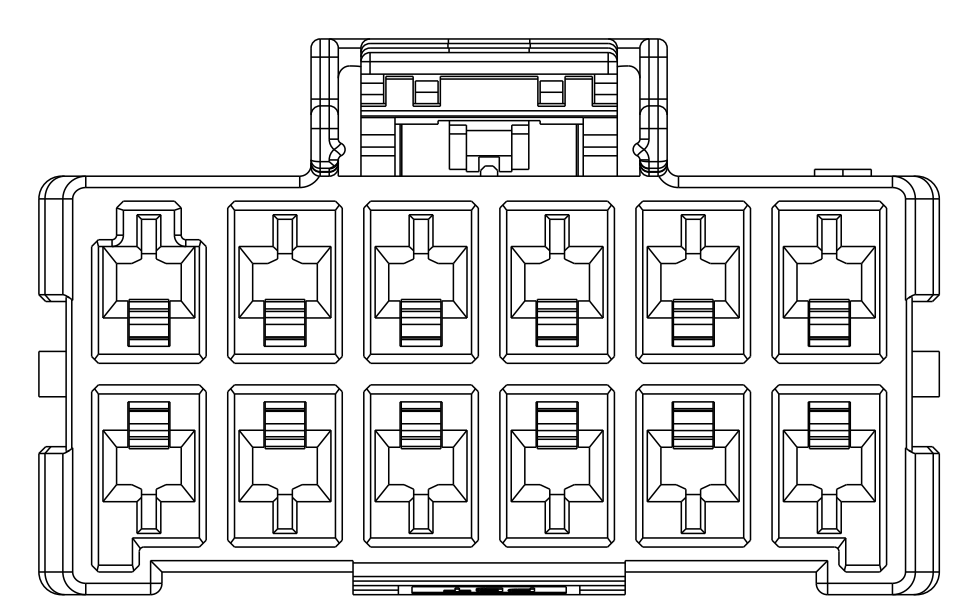
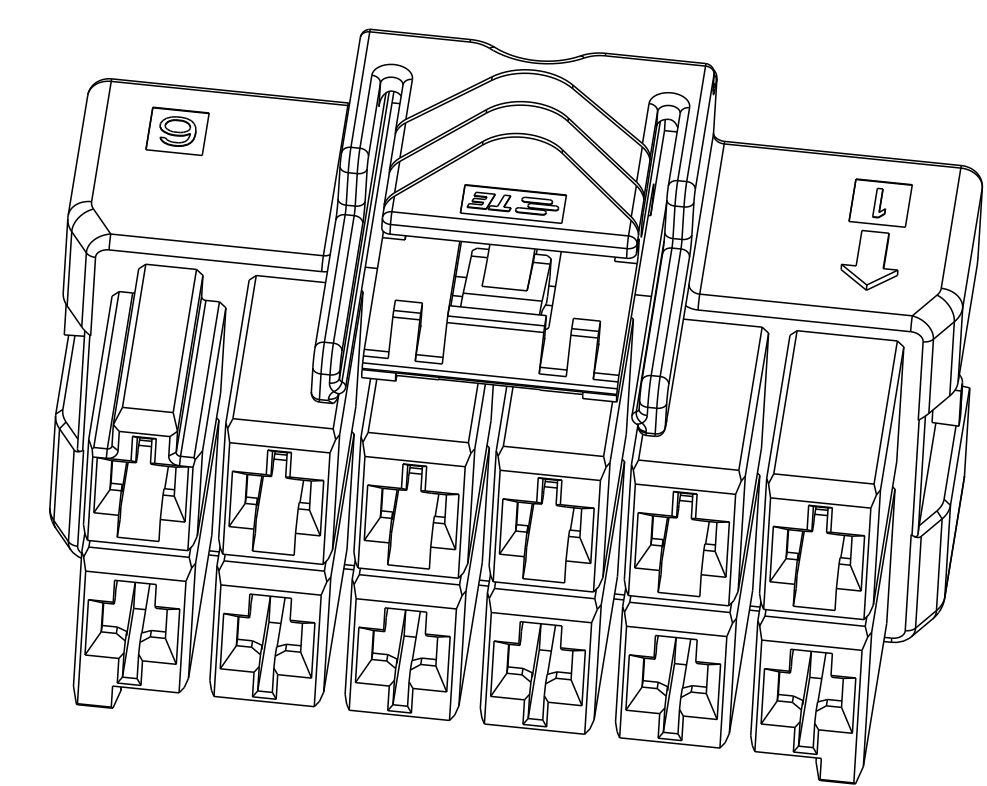

2\*6 POSITIONS

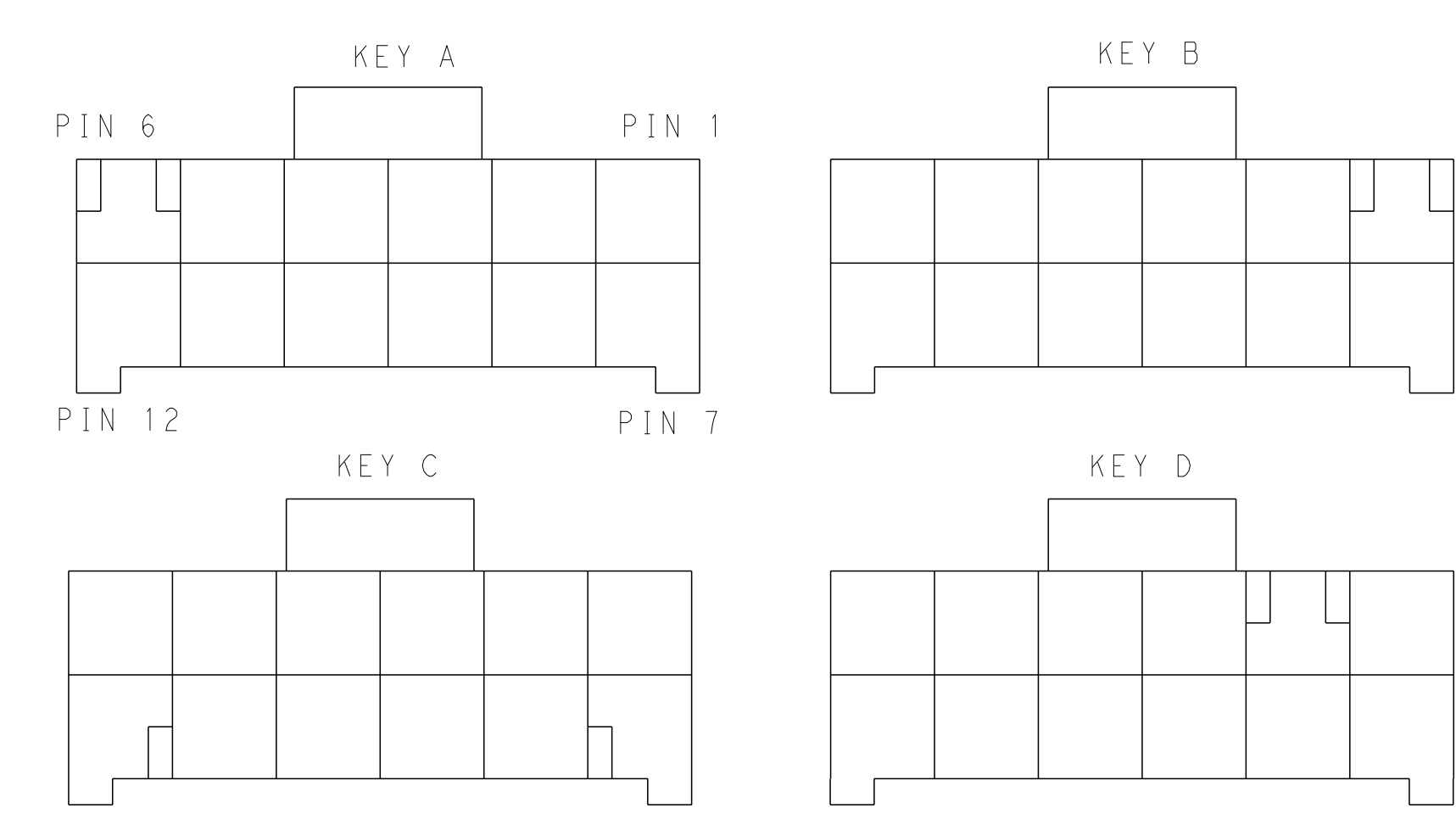

KEYING FOR 2\*6 POS.

POS.	MATERIAL	COLOR	KEY	P/N
2*6	LEVEL A	DARK GREY	KEY A	5-2232266-6
		BROWN	KEY B	6-2232266-6
		GREEN	KEY C	7-2232266-6
		ORANGE	KEY D	8-2232266-6
2*5	LEVEL A	DARK GREY	KEY A	5-2232266-5
		BROWN	KEY B	6-2232266-5
		GREEN	KEY C	7-2232266-5
		ORANGE	KEY D	8-2232266-5

POS.	MATERIAL	COLOR	KEY	P/N
2*4	LEVEL A	DARK GREY	KEY A	5-2232266-4
		BROWN	KEY B	6-2232266-4
		GREEN	KEY C	7-2232266-4
		ORANGE	KEY D	8-2232266-4
2*3	LEVEL A	DARK GREY	KEY A	5-2232266-3
		BROWN	KEY B	6-2232266-3
		GREEN	KEY C	7-2232266-3
		ORANGE	KEY D	8-2232266-3
LEVEL B	BLACK	KEY A	1-2232266-1	

THIS DRAWING IS A CONTROLLED DOCUMENT.

OWN: TOMMY\_WU 26MAR2013  
 CHK: TOMMY\_WU 26MAR2013  
 APVD: HAPYE\_WU 26MAR2013  
 YIHONG\_MAO 26MAR2013

STE TE Connectivity

PLUG HOUSING, DOUBLE ROW  
 POWER TRIPLE LOCK

SIZE: A1 CAGE CODE: 100779 DRAWING NO: 2232266  
 SCALE: SHEET 2 OF 2 REV B

Customer Drawing

# Mouser Electronics

Authorized Distributor

Click to View Pricing, Inventory, Delivery & Lifecycle Information:

[TE Connectivity:](#)

[5-2232266-6](#)