

IEC Connector C13, Rewireable, Angled

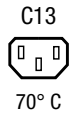

See below:  
[Approvals and Compliances](#)

**Description**

- Connector :  
Screwing cable terminal
- Pin temperature 70 °C , Protection class I , Cable
- Note: cable guard has to be ordered separately, mating cable guards please find under accessories

**References**

We recommend for new applications the type [4300-06](#)

**Weblinks**

[pdf datasheet](#), [html-datasheet](#), [General Product Information](#), [Distributor-Stock-Check](#), [Accessories](#), [Detailed request for product](#)

**Technical Data**

Ratings IEC	10A / 250VAC; 50Hz
Ratings UL/CSA	15A / 250VAC; 60Hz
Dielectric Strength	> 3kVAC between L-N > 1.5kVAC between L/N-PE (1 min/50Hz)
Allowable Operation Temperature	-25 °C to 70 °C
IP-Protection	from front side IP 20 acc. to IEC 60529
Insulation cover	Suitable for appliances with protection class I acc. to IEC 61140
Terminal	Screw clamps
Material: Housing	PA6, black or grey, UL 94V-0

appliance inlet/-outlet	C13 acc. to IEC 60320-1 UL 498, CSA C22.2 no. 42 (for cold conditions) pin-temperature 70 °C, 10A, Protection Class I
-------------------------	--

**Approvals and Compliances**

Detailed information on product approvals, code requirements, usage instructions and detailed test conditions can be looked up in [Details about Approvals](#)





**Approvals**

The approval mark is used by the testing authorities to certify compliance with the safety requirements placed on electronic products.  
 Approval Reference Type: 4012

Approval Logo	Certificates	Certification Body	Description
	<a href="#">VDE Approvals</a>	VDE	VDE Certificate Number: 40010002
	<a href="#">UL Approvals</a>	UL	UL File Number: E45115
	<a href="#">CSA Approvals</a>	CSA	CSA Certification Record: 1612079
	<a href="#">METI Approvals</a>	METI	Japan Electrical Safety and Environment technology Laboratories

## Product standards

Product standards that are referenced

Organization	Design	Standard	Description
	Designed according to	IEC 60320-1	Appliance couplers for household and similar general purposes
	Designed according to	IEC 60320-1	Appliance couplers for household and similar general purposes
	Designed according to	UL 498	Standard for Attachment Plugs and Receptacles
	Designed according to	CSA C22.2 no. 42	General Use Receptacles, Attachment Plugs, and Similar Wiring Devices





## Application standards

Application standards where the product can be used

Organization	Design	Standard	Description
	Designed for applications acc.	IEC/UL 60950	IEC 60950-1 includes the basic requirements for the safety of information technology equipment.

## Compliances

The product complies with following Guide Lines

Identification	Details	Initiator	Description
	<a href="#">CE declaration of conformity</a>	SCHURTER AG	The CE marking declares that the product complies with the applicable requirements laid down in the harmonisation of Community legislation on its affixing in accordance with EU Regulation 765/2008.
	RoHS	SCHURTER AG	EU Directive RoHS 2011/65/EU
	China RoHS	SCHURTER AG	The law SJ / T 11363-2006 (China RoHS) has been in force since 1 March 2007. It is similar to the EU directive RoHS.
	REACH	SCHURTER AG	On 1 June 2007, Regulation (EC) No 1907/2006 on the Registration, Evaluation, Authorization and Restriction of Chemicals 1 (abbreviated as "REACH") entered into force.

## Dimensions [mm]

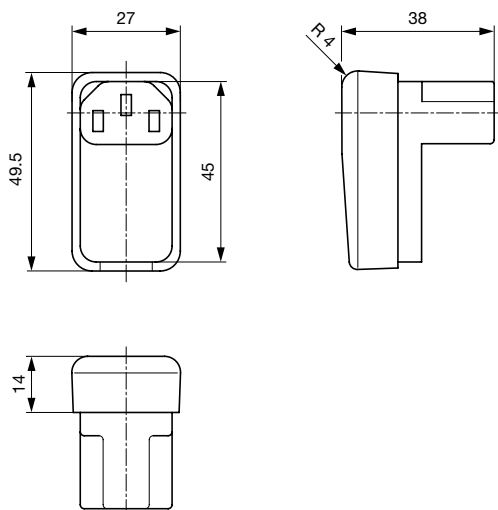

## All Variants

Color	Max. cable diameter	Max. wire size	Order Number
black	10 mm	3 x 1 mm <sup>2</sup>	4310.0019
grey	10 mm	3 x 1 mm <sup>2</sup>	4310.0020

 Most Popular.

Availability for all products can be searched real-time: <https://www.schurter.com/en/Stock-Check/Stock-Check-SCHURTER>

Max. torque for screws: Terminals: 0.5 Nm, Cable clamps: 0.8 Nm, Cover: 0.8 Nm

Packaging unit 50 Pcs

### Accessories

**Description**



Cable Guard KT14  
 PVC Cable Guard for rewireable connectors

### Mating Inlets/Plugs

**Category / Description**

[Appliance Inlet Overview complete](#)



6100-3, Mounting: Screw, Solder terminals or quick connect terminals, Appliance Inlet: IEC C14	6100-3
6100-4, Mounting: Snap-in, Solder terminals or quick connect terminals, Appliance Inlet: IEC C14	6100-4
6102-3, Mounting: Screw, Solder terminals or quick connect terminals, Appliance Inlet: IEC C18	6102-3
6102-5, Mounting: Snap-in, Solder terminals or quick connect terminals, Appliance Inlet: IEC C18	6102-5
G-Stecker, Mounting: Appliance Inlet : IEC C14 Without fuse holder	6150
<a href="#">Appliance Inlet further types to 4012</a>	...

[Distribution Unit Overview complete](#)



Distribution Unit for Snap-in Mounting with 1 IEC Appliance Inlet C14 and 1 Appliance Outlet F	0712
Distribution Unit with 1 IEC Appliance Inlet C14 and 2 Appliance Outlets F, Shuttered	4741
Distribution Unit with 1 IEC Appliance Inlet C14 and 4 Appliance Outlets F	4747
Distribution Unit with 1 IEC Appliance Inlet C14 or Power Cord, 4, 5 or 6 IEC Appliance Outlets F and Extra Components	4740
EMC Power Strip with Line Filter	FLBB
<a href="#">Distribution Unit further types to 4012</a>	...

[IEC Inlet Filter Overview complete](#)



GRF2, Mounting: Rear Side, With EMC-shield and without line filter, 10 A, Plug Connector, Appliance Inlet: IEC C14, Suitable for appliances with protection class I	GRF2
5110, Mounting: Screw, Front Side, Filter: Standard and Medical Version, Without fuse holder: 10 A, Thermoplastic Appliance Inlet: IEC C14, prewired, Suitable for appliances with protection class I	5110
KFS, Mounting: Screw, Front Side, Filter: Standard Version, Without fuse holder: 10 A, Appliance Inlet: IEC C14, pre-wired	KFS
<a href="#">IEC Inlet Filter further types to 4012</a>	...

[Plug Overview complete](#)



IEC Plug E, Cord Connector (Rewireable), Straight, max. cable Diameter 8.5 mm	4732
IEC Plug E, Cord Connector (Rewireable), Straight, max. Cable Diameter 10 mm	4735
IEC Plug E, Cord Connector (Rewireable), Straight	9009
IEC Plug E, Cord Connector (Rewireable), Angled, max. Cable Diameter 8.5 mm	4733
IEC Plug E, Cord Connector (Rewireable), Angled, max. Cable Diameter 10 mm	4736
<a href="#">Plug further types to 4012</a>	...

## Category / Description

## Power Entry Module Overview complete



DD11, Mounting: Screw-on mounting, Rocker switch: non-illuminated or illuminated 2-pole, Quick connect terminals 4.8 x 0.8 mm, Appliance Inlet: IEC C14, With or without protection cover, Fuse holder: 1 or 2 pole, Suitable for appliances with protection class I	DD11
DD21, Mounting: Screw-on mounting Rear Side, Rocker switch: non-illuminated or illuminated 2-pole, additional quick connect 4.8 x 0.8 mm Appliance Inlet: IEC C14, Fuse holder: 1 or 2 pole	DD21
DC11, Mounting: Screw, Rocker switch: non-illuminated or illuminated 1 or 2 pole, Quick connect terminals 4.8 x 0.8 mm, Appliance Inlet: IEC C14, Without fuse holder: Suitable for appliances with protection class I or II	DC11
KEB1, Mounting: Screw, Quick connect terminals 4.8 x 0.8 mm, Without fuse holder: Rocker switch, non-illuminated or illuminated, red, 1-pole, Appliance Inlet: IEC C14, 250 VAC, prewired, Suitable for appliances with protection class I	KEB1
KEB2, Mounting: Screw, Quick connect terminals 4.8 x 0.8 mm, Without fuse holder: Rocker switch, non-illuminated or illuminated, 2-pole, Appliance Inlet: IEC C14, 250 VAC, prewired, Suitable for appliances with protection class I	KEB2

[Power Entry Module further types to 4012](#)

...

## Power Entry Module with line filter Overview complete



DD14, Mounting: Screw-on mounting, Front Side, Filter, Standard and Medical Version, Fuse holder: 1 or 2 pole, 10 A, Rocker switch: 2-pole, non-illuminated Appliance Inlet: IEC C14, prewired	DD14
KFB1, Mounting: Screw, Front Side, Filter: Standard Version, Without fuse holder: 10 A, Rocker switch: 1-pole, Appliance Inlet: IEC C14, prewired	KFB1
KFB2, Mounting: Screw, Front Side, Filter: Standard and Medical Version, Without fuse holder: 10 A, Rocker switch: 2-pole, Appliance Inlet: IEC C14, prewired	KFB2
DC12, Mounting: Screw, Front-/Rear-Side, Filter, Standard and Medical Version, Without fuse holder: 10 A, Rocker switch: 1 or 2 pole, non-illuminated or illuminated Appliance Inlet: IEC C14, prewired	DC12
DC22 Mounting: Screw, Rear Side, PCB, 10 A, Filter: Standard and Medical Version, Without fuse holder: Rocker switch: 1 or 2 pole, non-illuminated or illuminated, Appliance Inlet: IEC C14, Suitable for appliances with protection class I	DC22

[Power Entry Module with line filter further types to 4012](#)

...

# Mouser Electronics

Authorized Distributor

Click to View Pricing, Inventory, Delivery & Lifecycle Information:

Schurter:

[4310.0019](#) [4310.002](#) [4310.0020](#) [4310.0002](#)