

INTERCONNECTS

SERIES 802 & 803 • .100" GRID (.030" DIA. PINS), STRAIGHT & RIGHT ANGLE HEADERS AND SOCKETS • DOUBLE ROW STRIPS

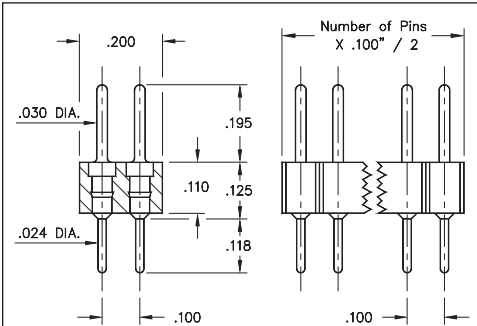

FIG. 1

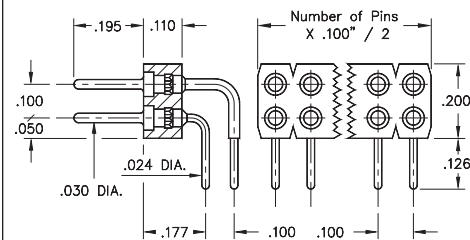

FIG. 2

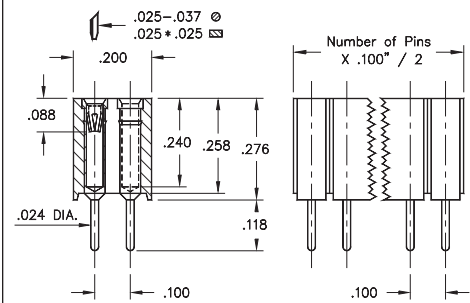

FIG. 3

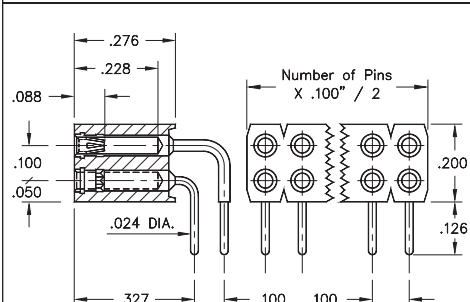
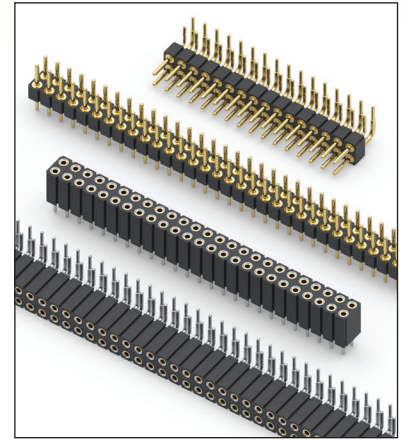







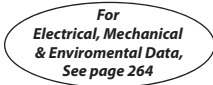



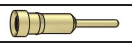



FIG. 4

- Pin interconnects available with straight MM #7007 or right angle MM #5005/5107 solder tails. See page 215 for details
- Sockets are available with straight MM #1304 or right angle MM #1305/1306 soldertails. See pages 177 and 179 for details
- MM #1304, #1305 and #1306 receptacles use Hi-Rel, 6-finger BeCu #47 contact rated at 4.5 amps. Receptacles accept .030" diameter and .025" square pins. See page 256 for details
- Insulators are high temperature thermoplastic, suitable for all soldering operations



ORDERING INFORMATION

FIG. 1	Series 802...10-001	Straight Pin Header						
	802-XX-0- -10-001000	Specify number of pins \uparrow 04-64						
FIG. 2	Series 802...20-001	Right Angle Pin Header						
	802-XX-0- -20-001000	Specify number of pins \uparrow 02-64						
								
SPECIFY PLATING CODE XX=		10 	90	40 				
Pin Plating 		10 μ " Au	200 μ " Sn/Pb	200 μ " Sn				
FIG. 3	Series 803...10-001	Straight Socket						
	803-XX- -10-001000	Specify number of pins \uparrow 004-100						
FIG. 4	Series 803...20-001	Right Angle Socket						
	803-XX- -20-001000	Specify number of pins \uparrow 002-100						
								
SPECIFY PLATING CODE XX=			91	93	99	41 	43 	47 
Sleeve (Pin) 			200 μ " Sn/Pb	200 μ " Sn/Pb	200 μ " Sn/Pb	200 μ " Sn	200 μ " Sn	200 μ " Sn
Contact (Clip) 			10 μ " Au	30 μ " Au	100 μ " Sn/Pb	10 μ " Au	30 μ " Au	Au Flash



Mouser Electronics

Authorized Distributor

Click to View Pricing, Inventory, Delivery & Lifecycle Information:

Mill-Max:

[803-99-100-10-001000](#) [803-99-072-10-001000](#) [803-93-100-10-001000](#) [803-93-072-20-001000](#) [802-90-064-20-001000](#) [802-90-064-10-001000](#) [803-43-014-10-001000](#) [803-43-100-20-001000](#) [803-43-072-10-001000](#) [802-10-064-20-001000](#) [802-10-064-10-001000](#) [803-93-100-20-001000](#) [803-99-026-20-001000](#) [803-93-072-10-001000](#) [803-43-006-10-001000](#) [803-93-018-10-001000](#) [803-43-100-10-001000](#) [803-43-072-20-001000](#) [802-40-064-20-001000](#) [802-40-064-10-001000](#) [803-93-030-10-001000](#) [803-43-010-10-001000](#) [803-43-006-20-001000](#) [803-43-008-10-001000](#) [803-43-004-20-001000](#) [803-43-064-10-001000](#) [803-43-008-20-001000](#) [803-43-004-10-001000](#) [803-43-064-20-001000](#) [803-43-010-20-001000](#) [802-10-064-10-001100](#) [802-10-028-20-001100](#)