



# 60×60×25 mm

San Ace 60W 9WL type   

## General Specifications

- Material ..... Frame: Aluminum (Black coating), Impeller: Plastic (Flammability: UL 94V-1)
- Expected life ..... See the table below. (L10 life: 90% survival rate for continuous operation in indoor free air at 60°C, rated voltage)
- Motor protection function ..... Locked rotor burnout protection, Reverse polarity protection  
For details, please refer to p. 547.
- Dielectric strength ..... 50/60 Hz, 500 VAC, for 1 minute (between lead wire conductors and frame)
- Insulation resistance ..... 10 MΩ or more with a 500 VDC megger (between lead wire conductors and frame)
- Sound pressure level (SPL) ..... At 1 m away from the air inlet
- Storage temperature ..... -30 to +70°C (Non-condensing)
- Lead wire ..... ⊕Red ⊖Black Sensor Yellow Control Brown
- Mass ..... 120 g
- Ingress protection ..... IP68

## Specifications

The models listed below **have pulse sensors with PWM control function.**

Model no.	Rated voltage [V]	Operating voltage range [V]	PWM duty cycle* [%]	Rated current [A]	Rated input [W]	Rated speed [min <sup>-1</sup> ]	Max. airflow [m <sup>3</sup> /min] [CFM]	Max. static pressure [Pa] [inchH <sub>2</sub> O]	SPL [dB (A)]	Operating temperature [°C]	Expected life [h]
9WL0612P4S001	12	10.8 to 13.2	100	0.67	8.04	11000	1.4 49.4	300 1.204	53	-20 to +70	180000/60°C
			20	0.06	0.72	2900	0.36 12.7	20.8 0.083	20		
9WL0612P4J001			100	0.39	4.68	8650	1.1 38.8	182 0.73	47		
			20	0.03	0.36	1150	0.13 4.8	3.3 0.013	14		
9WL0612P4H001			100	0.17	2.04	6150	0.78 27.5	97 0.389	36		
			20	0.03	0.36	1350	0.17 6.0	4.7 0.018	14		
9WL0624P4S001	24	21.6 to 26.4	100	0.34	8.16	11000	1.4 49.4	300 1.204	53		
			20	0.03	0.72	2900	0.36 12.7	20.8 0.083	20		
9WL0624P4J001			100	0.19	4.56	8650	1.1 38.8	182 0.73	47		
			20	0.02	0.48	2200	0.28 9.8	12.0 0.048	17		
9WL0624P4H001			100	0.08	1.92	6150	0.78 27.5	97 0.389	36		
			20	0.02	0.48	1300	0.16 5.6	4.3 0.017	14		

\* PWM frequency: 25 kHz. Fan does not rotate when PWM duty cycle is 0%.

The following sensor and control options are available for selection.

Differs according to the model. Refer to the table on p. 579. Without sensor Pulse sensor Lock sensor

## Airflow - Static Pressure Characteristics / PWM Duty - Speed Characteristics Example

**9WL0612P4S001** With pulse sensor with PWM control function

PWM duty cycle

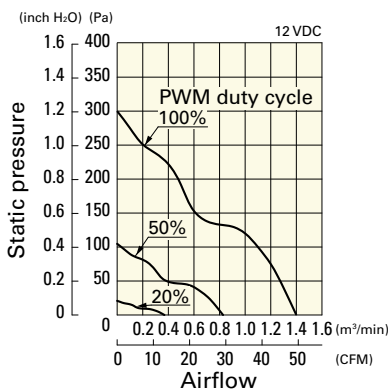

Operating voltage range

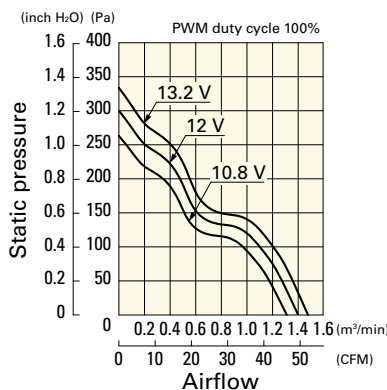

PWM duty - Speed characteristics example

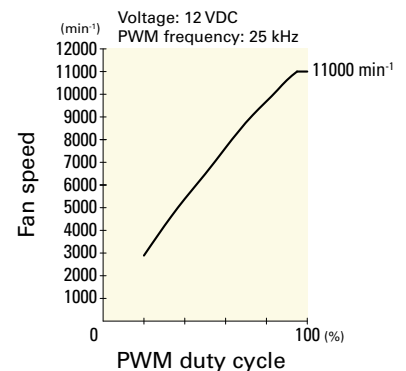

# Airflow - Static Pressure Characteristics / PWM Duty - Speed Characteristics Example

**9WL0612P4J001** With pulse sensor with PWM control function

PWM duty cycle

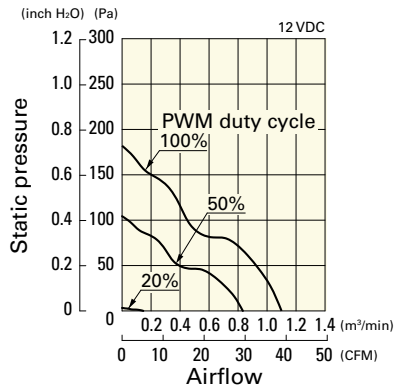

Operating voltage range

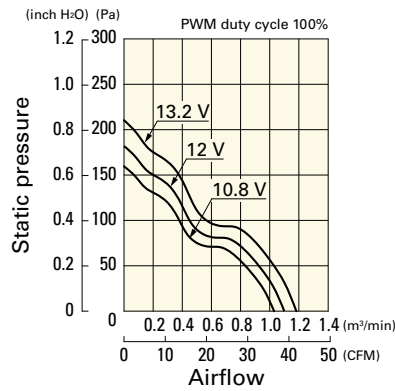

PWM duty - Speed characteristics example

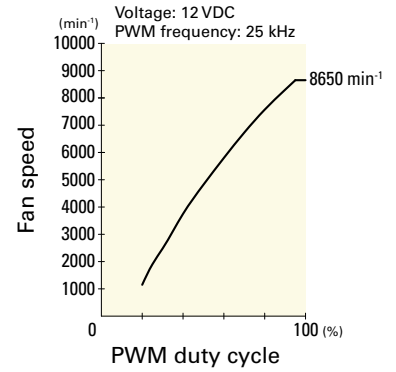

**9WL0612P4H001** With pulse sensor with PWM control function

PWM duty cycle

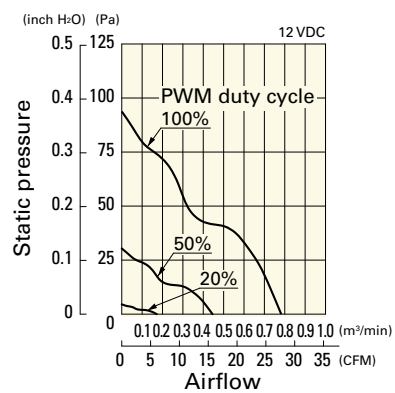

Operating voltage range

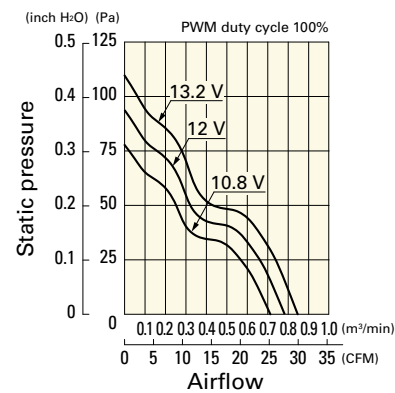

PWM duty - Speed characteristics example

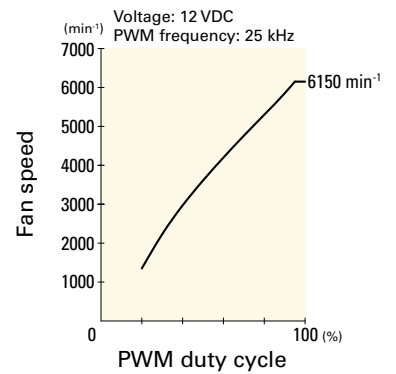

**9WL0624P4S001** With pulse sensor with PWM control function

PWM duty cycle

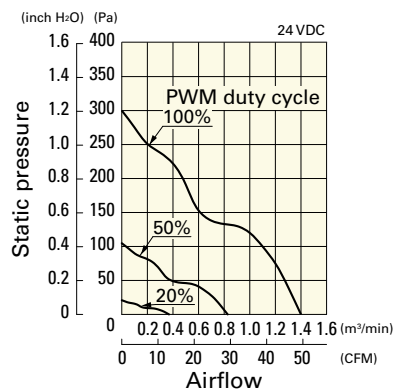

Operating voltage range

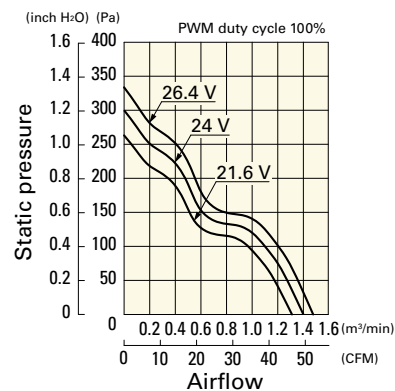

PWM duty - Speed characteristics example

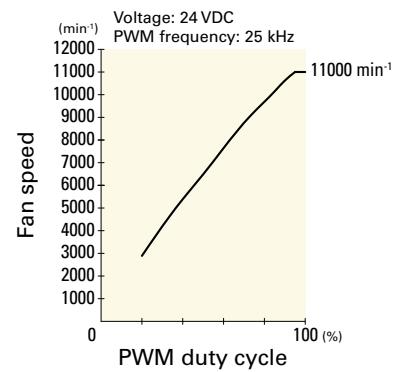

**9WL0624P4J001** With pulse sensor with PWM control function

PWM duty cycle

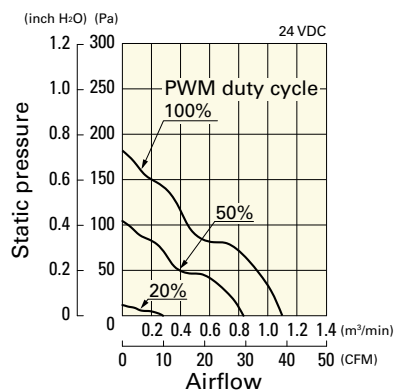

Operating voltage range

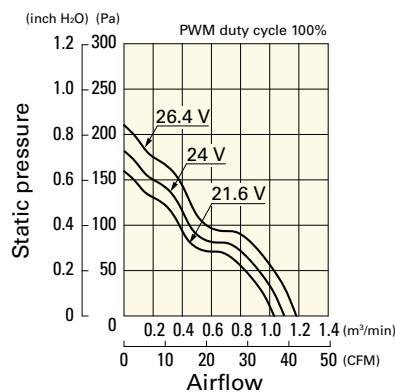

PWM duty - Speed characteristics example

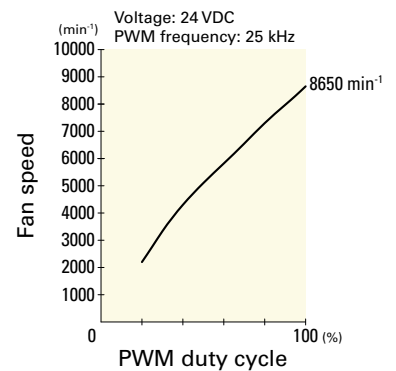

## Airflow - Static Pressure Characteristics / PWM Duty - Speed Characteristics Example

**9WL0624P4H001** With pulse sensor with PWM control function

PWM duty cycle

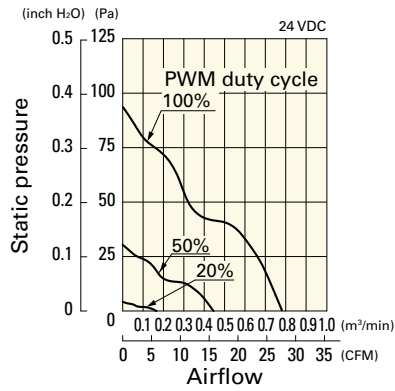

Operating voltage range

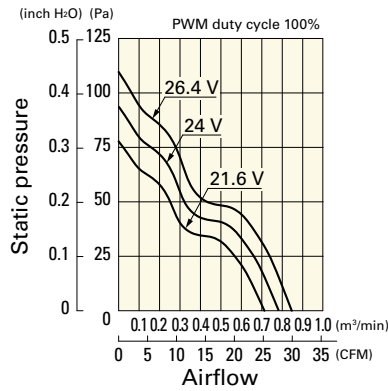

PWM duty - Speed characteristics example

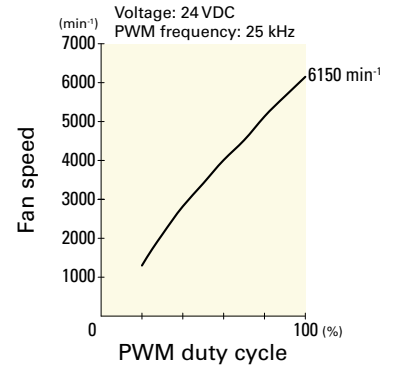

## Dimensions (unit: mm)

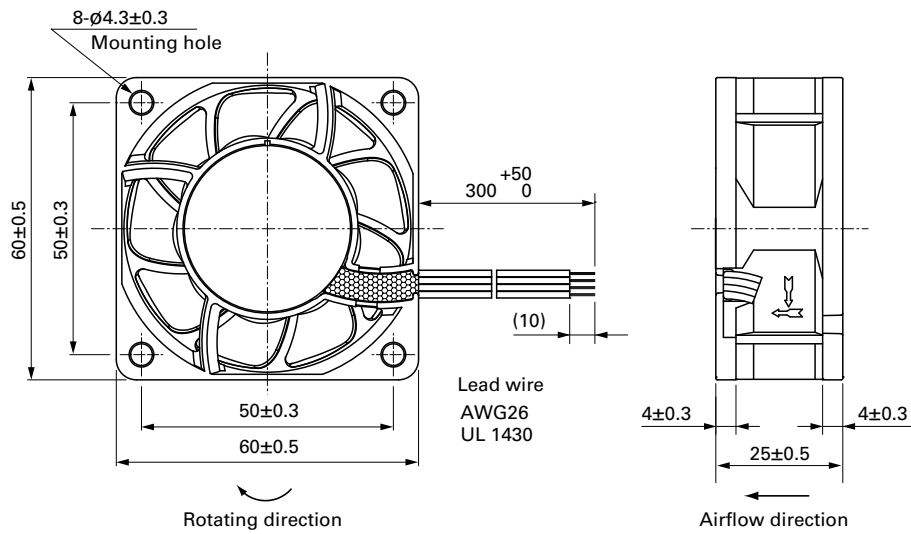

## Reference Dimensions of Mounting Holes and Vent Opening (unit: mm)

Inlet side, Outlet side

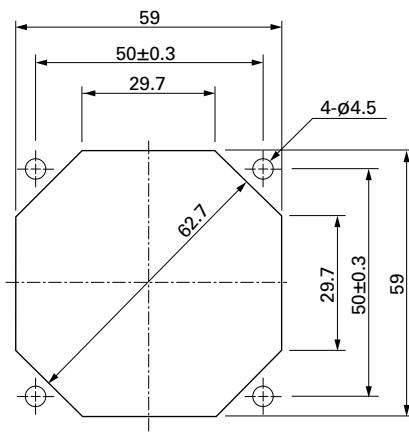

## Options

Finger guards

page: p. 532

Model no.: 109-139E, 109-139H

Resin finger guards

page: p. 539

Model no.: 109-1003G

DC  
Splash Proof Fan 60 mm sq.

# Mouser Electronics

Authorized Distributor

Click to View Pricing, Inventory, Delivery & Lifecycle Information:

## Sanyo Denki:

[9WL0612P4H001](#) [9WL0624P4H001](#) [9WL0624P4S001](#) [9WL0612P4J001](#) [9WL0612P4S001](#) [9WL0624P4J001](#)  
[9WL0612J4002](#) [9WL0612J4D001](#) [9WL0612S4002](#) [9WL0612S4D001](#) [9WL0624H4001](#) [9WL0624S4001](#)  
[9WL0624S4002](#) [9WL0612H4002](#)