

### Extrusion

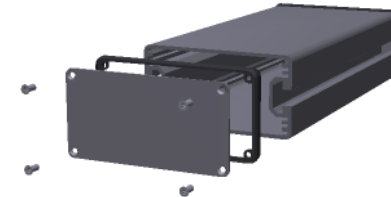

### End Plate

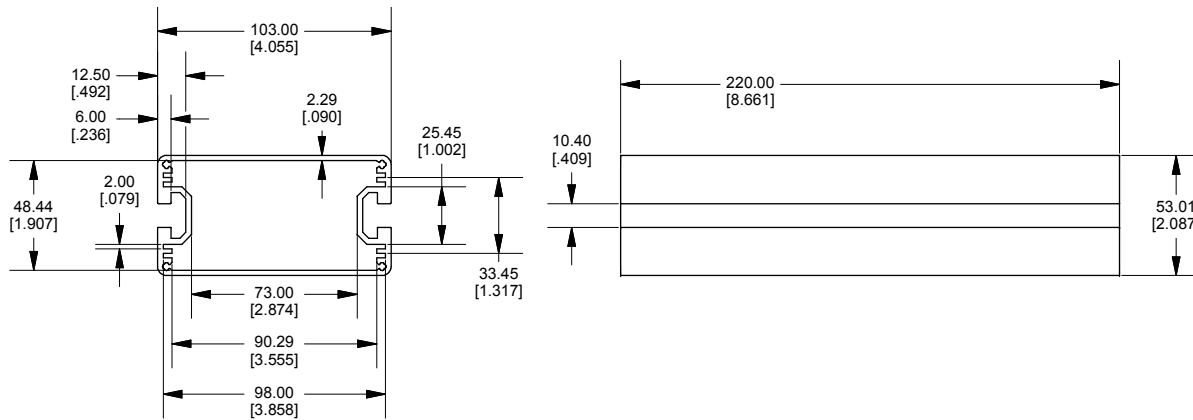
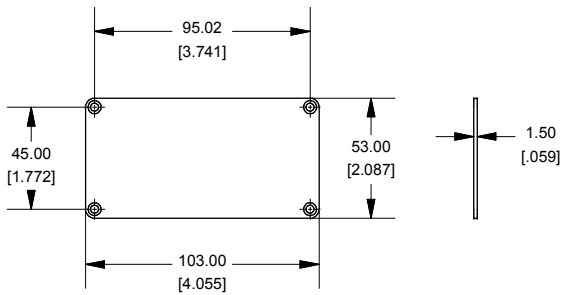

### Open Bezel

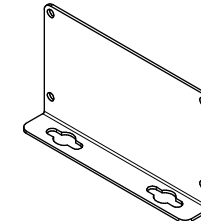
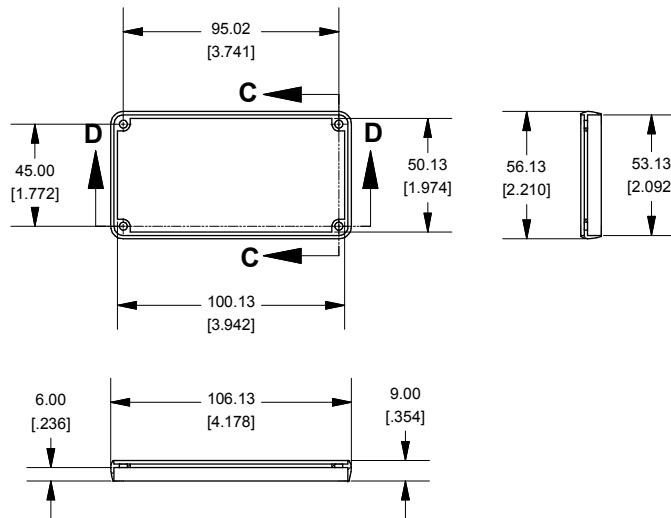

### OPTIONAL FLANGE END PANELS 1455NF

Enclosures can be Factory Modified ( Milling, Drilling, Printing etc.)  
Solid models of this enclosure available in STEP or IGES.  
Contact Factory [mjm@hammondmg.com](mailto:mjm@hammondmg.com)

NOTE	
Purchased assembly includes extrusion, plastic bezels, end panels, #6 Taptight screws and self adhesive rubber feet.	
Box made from Extruded Aluminum 6063.	
Bezels made from polycarbonate.	

1455NC2201	
PART NUMBERS	
Clear Anodized	1455NC2201
ACCESSORIES	
T Bolt (M8 x 20)	1455TBOLT
T Nut (M8)	1455TNUT
T Spring Nut (M8)	1455TSNUT

