

Ultrafast Plastic Rectifier

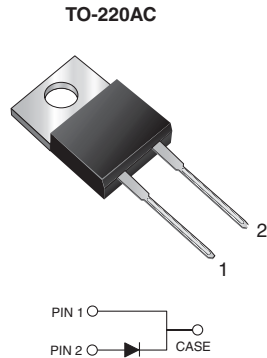

FEATURES

- Power pack
- Glass passivated pellet chip junction
- Ultrafast recovery time
- Low switching losses, high efficiency
- Low leakage current
- High forward surge capability
- Solder dip 275 °C max., 10 s per JESD 22-B106
- Material categorization: for definitions of compliance please see www.vishay.com/doc?99912

RoHS
COMPLIANT

TYPICAL APPLICATIONS

For use in high frequency rectifier of switching mode power supplies, inverters, freewheeling diodes, DC/DC converters, and other power switching application.

MECHANICAL DATA

Case: TO-220AC

Molding compound meets UL 94V-0 flammability rating
Base P/N-E3 - RoHS-compliant, commercial grade

Terminals: matte tin plated leads, solderable per J-STD-002 and JESD22-B102

E3 suffix meets JESD 201 class 1A whisker test

Polarity: as marked

Mounting Torque: 10 in-lbs max.

PRIMARY CHARACTERISTICS	
$I_{F(AV)}$	8.0 A
V_{RRM}	50 V, 100 V, 150 V, 200 V
I_{FSM}	125 A
t_{rr}	35 ns
V_F at I_F	0.895 V
T_J max.	150 °C
Package	TO-220AC
Diode variation	Single

MAXIMUM RATINGS ($T_A = 25$ °C unless otherwise noted)						
PARAMETER	SYMBOL	GI1401	GI1402	GI1403	GI1404	UNIT
Max. repetitive peak reverse voltage	V_{RRM}	50	100	150	200	V
Max. RMS voltage	V_{RMS}	35	70	105	140	V
Max. DC blocking voltage	V_{DC}	50	100	150	200	V
Max. average forward rectified current at $T_C = 125$ °C	$I_{F(AV)}$	8.0				A
Peak forward surge current 8.3 ms single half sine-wave superimposed on rated load	I_{FSM}	125				A
Operating and storage temperature range	T_J, T_{STG}	-65 to +150				°C

ELECTRICAL CHARACTERISTICS ($T_A = 25$ °C unless otherwise noted)								
PARAMETER	TEST CONDITIONS		SYMBOL	GI1401	GI1402	GI1403	GI1404	UNIT
Max. instantaneous forward voltage	$I_F = 4$ A	$T_J = 25$ °C	V_F	0.900				V
	$I_F = 8$ A	$T_J = 25$ °C		0.975				
	$I_F = 4$ A	$T_J = 100$ °C		0.800				
	$I_F = 8$ A	$T_J = 100$ °C		0.895				
Max. DC reverse current at rated DC blocking voltage	$T_C = 25$ °C		I_R	5.0				µA
	$T_C = 100$ °C			150				
Max. reverse recovery time	$I_F = 0.5$ A, $I_R = 1.0$ A, $t_{rr} = 0.25$ A		t_{rr}	35				ns
Typical junction capacitance	4.0 V, 1 MHz		C_J	85				pF



THERMAL CHARACTERISTICS ($T_A = 25\text{ }^\circ\text{C}$ unless otherwise noted)						
PARAMETER	SYMBOL	GI1401	GI1402	GI1403	GI1404	UNIT
Typical thermal resistance ⁽¹⁾⁽²⁾	$R_{\theta JA}$	15				$^\circ\text{C/W}$
	$R_{\theta JC}$	2.2				

Notes

- (1) Thermal resistance from junction to ambient in free air, no heatsink
- (2) Thermal resistance from junction to case and ambient mounted on heatsink

ORDERING INFORMATION (Example)					
PACKAGE	PREFERRED P/N	UNIT WEIGHT (g)	PACKAGE CODE	BASE QUANTITY	DELIVERY MODE
TO-220AC	GI1401-E3/45	1.80	45	50/tube	Tube

RATINGS AND CHARACTERISTICS CURVES ($T_A = 25\text{ }^\circ\text{C}$ unless otherwise noted)

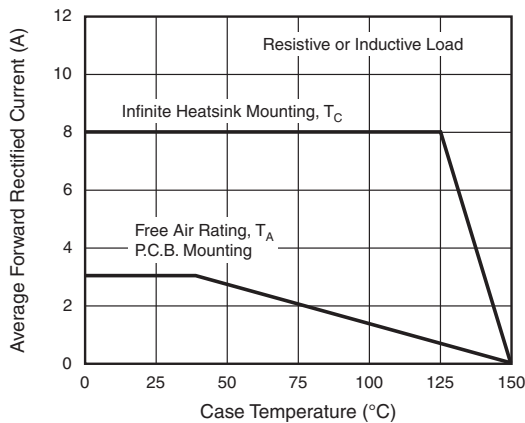

Fig. 1 - Max. Forward Current Derating Curve

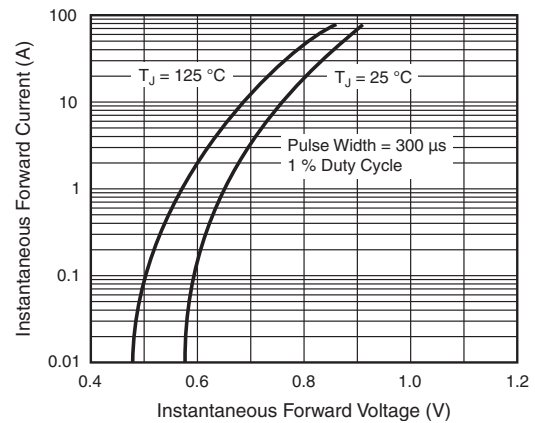

Fig. 3 - Typical Instantaneous Forward Characteristics

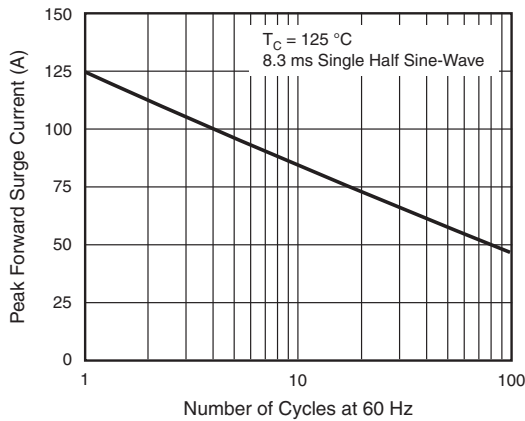

Fig. 2 - Max. Non-Repetitive Peak Forward Surge Current

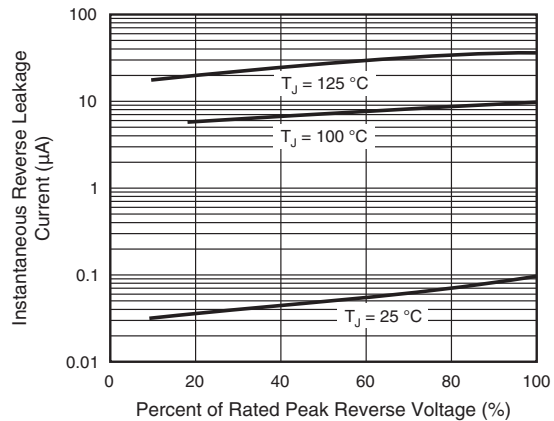

Fig. 4 - Typical Reverse Leakage Characteristics

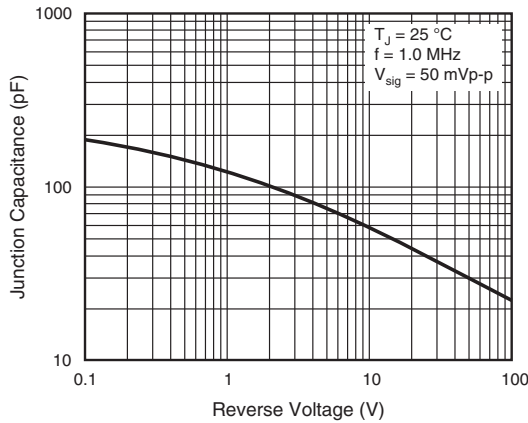
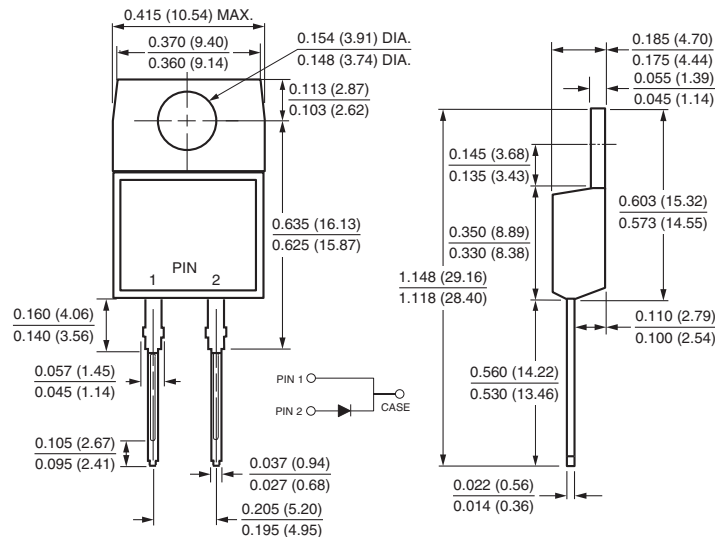

Fig. 5 - Typical Junction Capacitance

PACKAGE OUTLINE DIMENSIONS in inches (millimeters)

TO-220AC





Disclaimer

ALL PRODUCT, PRODUCT SPECIFICATIONS AND DATA ARE SUBJECT TO CHANGE WITHOUT NOTICE TO IMPROVE RELIABILITY, FUNCTION OR DESIGN OR OTHERWISE.

Vishay Intertechnology, Inc., its affiliates, agents, and employees, and all persons acting on its or their behalf (collectively, "Vishay"), disclaim any and all liability for any errors, inaccuracies or incompleteness contained in any datasheet or in any other disclosure relating to any product.

Vishay makes no warranty, representation or guarantee regarding the suitability of the products for any particular purpose or the continuing production of any product. To the maximum extent permitted by applicable law, Vishay disclaims (i) any and all liability arising out of the application or use of any product, (ii) any and all liability, including without limitation special, consequential or incidental damages, and (iii) any and all implied warranties, including warranties of fitness for particular purpose, non-infringement and merchantability.

Statements regarding the suitability of products for certain types of applications are based on Vishay's knowledge of typical requirements that are often placed on Vishay products in generic applications. Such statements are not binding statements about the suitability of products for a particular application. It is the customer's responsibility to validate that a particular product with the properties described in the product specification is suitable for use in a particular application. Parameters provided in datasheets and / or specifications may vary in different applications and performance may vary over time. All operating parameters, including typical parameters, must be validated for each customer application by the customer's technical experts. Product specifications do not expand or otherwise modify Vishay's terms and conditions of purchase, including but not limited to the warranty expressed therein.

Except as expressly indicated in writing, Vishay products are not designed for use in medical, life-saving, or life-sustaining applications or for any other application in which the failure of the Vishay product could result in personal injury or death. Customers using or selling Vishay products not expressly indicated for use in such applications do so at their own risk. Please contact authorized Vishay personnel to obtain written terms and conditions regarding products designed for such applications.

No license, express or implied, by estoppel or otherwise, to any intellectual property rights is granted by this document or by any conduct of Vishay. Product names and markings noted herein may be trademarks of their respective owners.