

# BCW30LT1G, SBCW30LT1G

## General Purpose Transistors

### PNP Silicon

#### Features

- S Prefix for Automotive and Other Applications Requiring Unique Site and Control Change Requirements; AEC-Q101 Qualified and PPAP Capable
- These Devices are Pb-Free, Halogen Free/BFR Free and are RoHS Compliant

#### MAXIMUM RATINGS

Rating	Symbol	Value	Unit
Collector – Emitter Voltage	$V_{CEO}$	-32	Vdc
Collector – Base Voltage	$V_{CBO}$	-32	Vdc
Emitter-Base Voltage	$V_{EBO}$	-5.0	Vdc
Collector Current – Continuous	$I_C$	-100	mAdc

#### THERMAL CHARACTERISTICS

Characteristic	Symbol	Value	Unit
Total Device Dissipation FR-5 Board (Note 1) $T_A = 25^\circ\text{C}$ Derate above $25^\circ\text{C}$	$P_D$	225	mW
Thermal Resistance, Junction-to-Ambient	$R_{\theta JA}$	556	$^\circ\text{C/W}$
Total Device Dissipation Alumina Substrate (Note 2) $T_A = 25^\circ\text{C}$ Derate above $25^\circ\text{C}$	$P_D$	300	mW
Thermal Resistance, Junction-to-Ambient	$R_{\theta JA}$	417	$^\circ\text{C/W}$
Junction and Storage Temperature	$T_J, T_{stg}$	-55 to +150	$^\circ\text{C}$

Stresses exceeding those listed in the Maximum Ratings table may damage the device. If any of these limits are exceeded, device functionality should not be assumed, damage may occur and reliability may be affected.

1. FR-5 =  $1.0 \times 0.75 \times 0.062$  in.
2. Alumina =  $0.4 \times 0.3 \times 0.024$  in. 99.5% alumina.



ON Semiconductor®

[www.onsemi.com](http://www.onsemi.com)

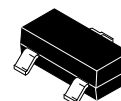

SOT-23 (TO-236)  
CASE 318-08  
STYLE 6

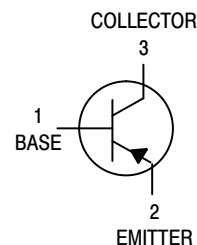

#### MARKING DIAGRAM

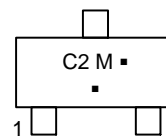

C2 = Specific Device Code  
M = Date Code\*  
▪ = Pb-Free Package

(Note: Microdot may be in either location)

\*Date Code orientation and/or overbar may vary depending upon manufacturing location.

#### ORDERING INFORMATION

Device	Package	Shipping
BCW30LT1G	SOT-23 (Pb-Free)	3,000/Tape & Reel
SBCW30LT1G	SOT-23 (Pb-Free)	3,000/Tape & Reel

†For information on tape and reel specifications, including part orientation and tape sizes, please refer to our Tape and Reel Packaging Specifications Brochure, BRD8011/D.

# BCW30LT1G, SBCW30LT1G

## ELECTRICAL CHARACTERISTICS ( $T_A = 25^\circ\text{C}$ unless otherwise noted)

Characteristic	Symbol	Min	Max	Unit
<b>OFF CHARACTERISTICS</b>				
Collector–Emitter Breakdown Voltage ( $I_C = -2.0\text{ mA}$ , $I_E = 0$ )	$V_{(BR)CEO}$	-32	-	Vdc
Collector–Emitter Breakdown Voltage ( $I_C = -100\ \mu\text{A}$ , $V_{EB} = 0$ )	$V_{(BR)CES}$	-32	-	Vdc
Collector–Base Breakdown Voltage ( $I_C = -10\ \mu\text{A}$ , $I_C = 0$ )	$V_{(BR)CBO}$	-32	-	Vdc
Emitter–Base Breakdown Voltage ( $I_E = -10\ \mu\text{A}$ , $I_C = 0$ )	$V_{(BR)EBO}$	-5.0	-	Vdc
Collector Cutoff Current ( $V_{CB} = -32\text{ Vdc}$ , $I_E = 0$ ) ( $V_{CB} = -32\text{ Vdc}$ , $I_E = 0$ , $T_A = 100^\circ\text{C}$ )	$I_{CBO}$	-	-100 -10	nAdc $\mu\text{Adc}$

## ON CHARACTERISTICS

DC Current Gain ( $I_C = -2.0\text{ mA}$ , $V_{CE} = -5.0\text{ Vdc}$ )	$h_{FE}$	215	500	-
Collector–Emitter Saturation Voltage ( $I_C = -10\text{ mA}$ , $I_B = -0.5\text{ mA}$ )	$V_{CE(sat)}$	-	-0.3	Vdc
Base–Emitter On Voltage ( $I_C = -2.0\text{ mA}$ , $V_{CE} = -5.0\text{ Vdc}$ )	$V_{BE(on)}$	-0.6	-0.75	Vdc

## SMALL-SIGNAL CHARACTERISTICS

Output Capacitance ( $I_E = 0$ , $V_{CB} = -10\text{ Vdc}$ , $f = 1.0\text{ MHz}$ )	$C_{obo}$	-	7.0	pF
Noise Figure ( $I_C = -0.2\text{ mA}$ , $V_{CE} = -5.0\text{ Vdc}$ , $R_S = 2.0\text{ k}\Omega$ , $f = 1.0\text{ kHz}$ , $BW = 200\text{ Hz}$ )	NF	-	10	dB

Product parametric performance is indicated in the Electrical Characteristics for the listed test conditions, unless otherwise noted. Product performance may not be indicated by the Electrical Characteristics if operated under different conditions.

## TYPICAL NOISE CHARACTERISTICS

( $V_{CE} = -5.0\text{ Vdc}$ ,  $T_A = 25^\circ\text{C}$ )

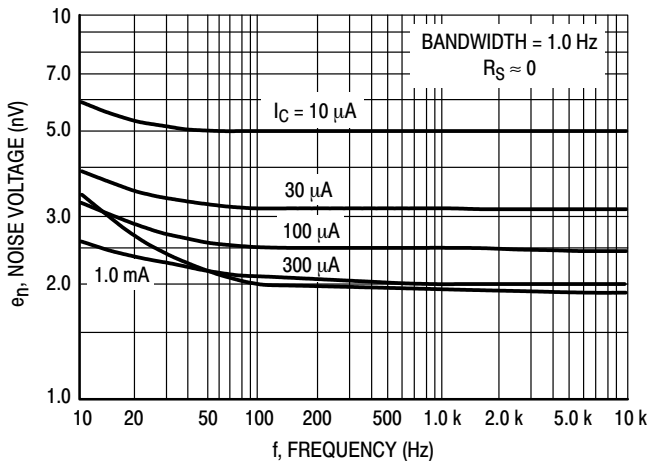

Figure 1. Noise Voltage

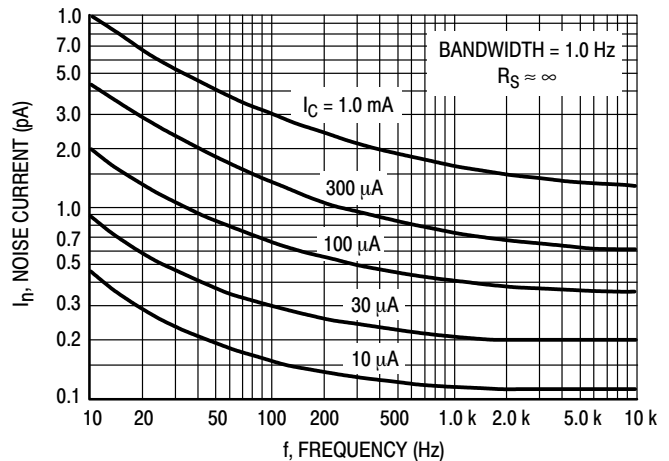

Figure 2. Noise Current

# BCW30LT1G, SBCW30LT1G

## NOISE FIGURE CONTOURS

( $V_{CE} = -5.0 \text{ Vdc}$ ,  $T_A = 25^\circ\text{C}$ )

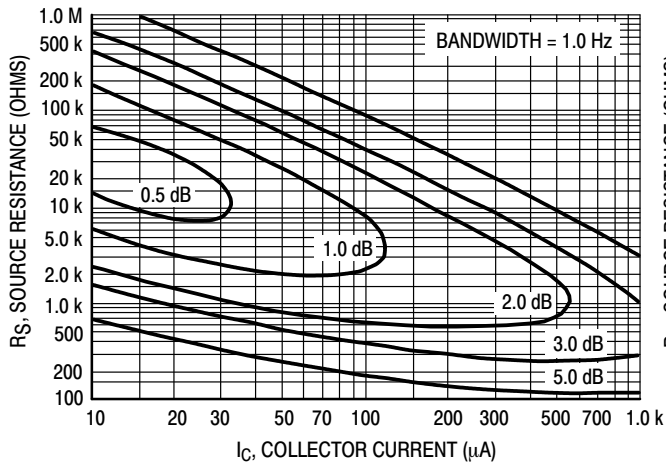

Figure 3. Narrow Band, 100 Hz

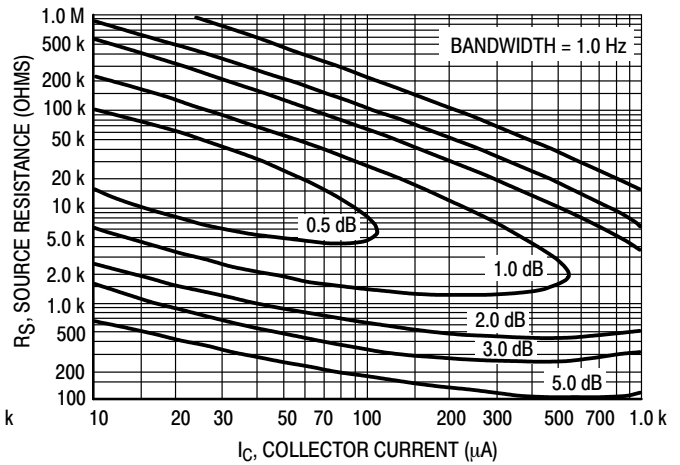

Figure 4. Narrow Band, 1.0 kHz

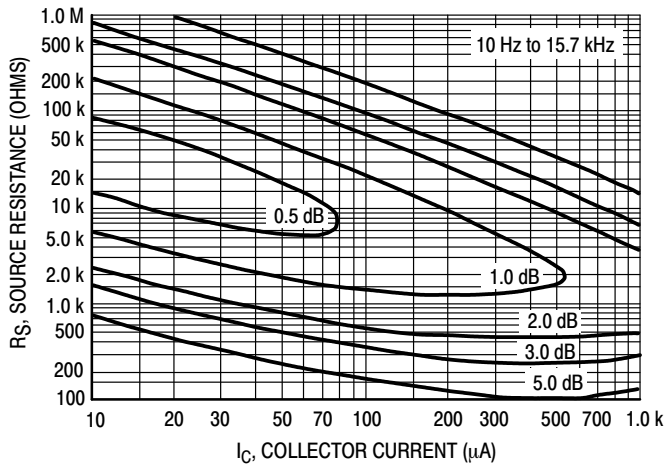

Figure 5. Wideband

Noise Figure is Defined as:

$$NF = 20 \log_{10} \left[ \frac{e_n^2 + 4KTR_S + I_n^2 R_S^2}{4KTR_S} \right]^{1/2}$$

$e_n$  = Noise Voltage of the Transistor referred to the input. (Figure 3)

$I_n$  = Noise Current of the Transistor referred to the input. (Figure 4)

$K$  = Boltzman's Constant ( $1.38 \times 10^{-23} \text{ J/}^\circ\text{K}$ )

$T$  = Temperature of the Source Resistance ( $^\circ\text{K}$ )

$R_S$  = Source Resistance (Ohms)

# BCW30LT1G, SBCW30LT1G

## TYPICAL STATIC CHARACTERISTICS

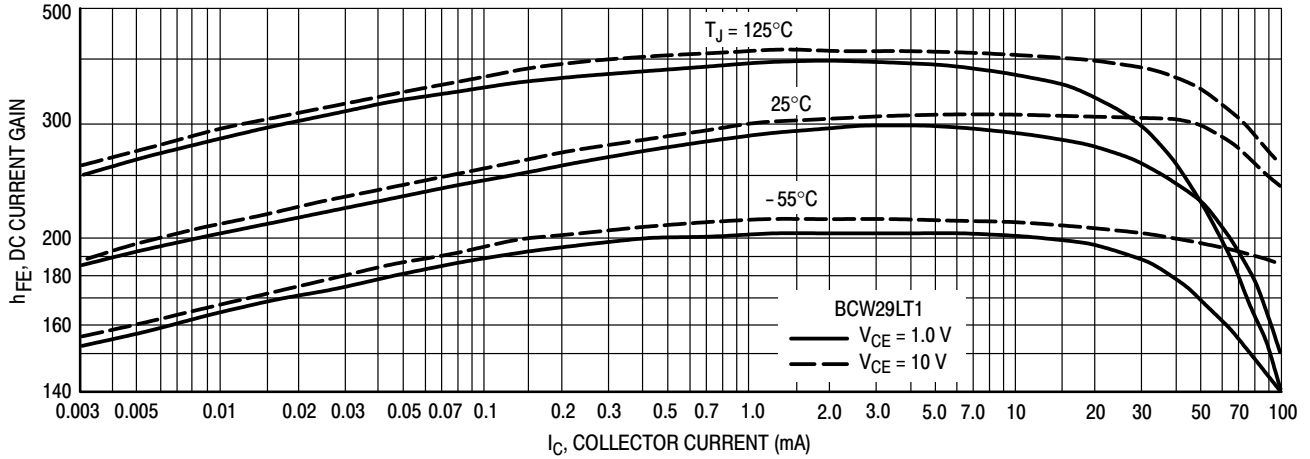

Figure 6. DC Current Gain

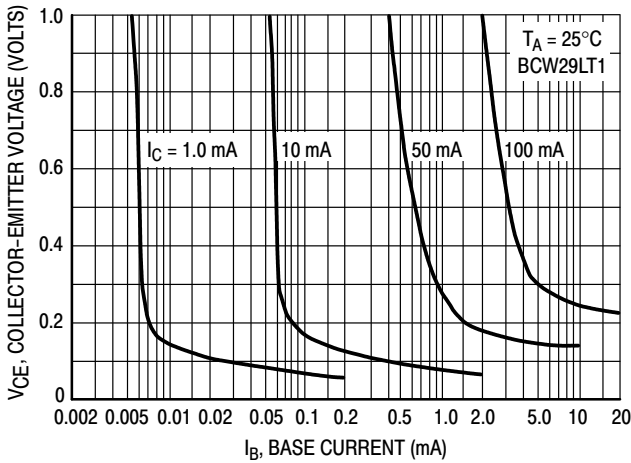

Figure 7. Collector Saturation Region

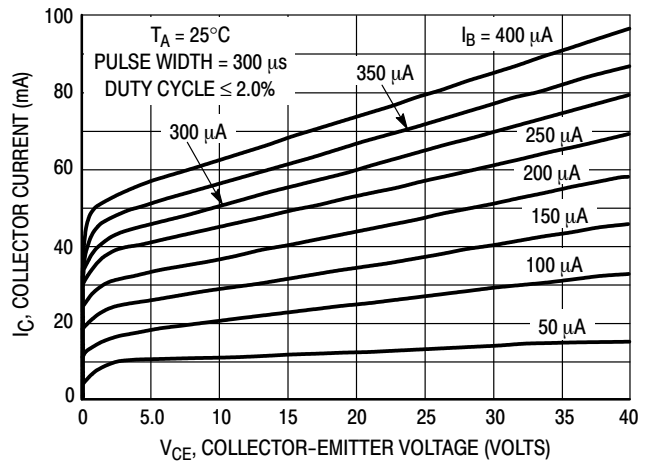

Figure 8. Collector Characteristics

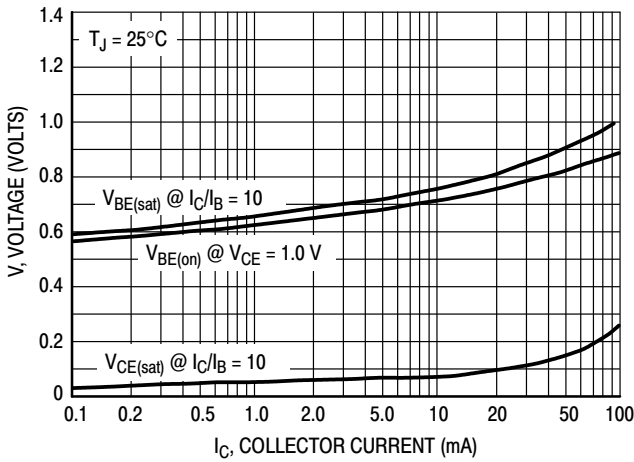

Figure 9. "On" Voltages

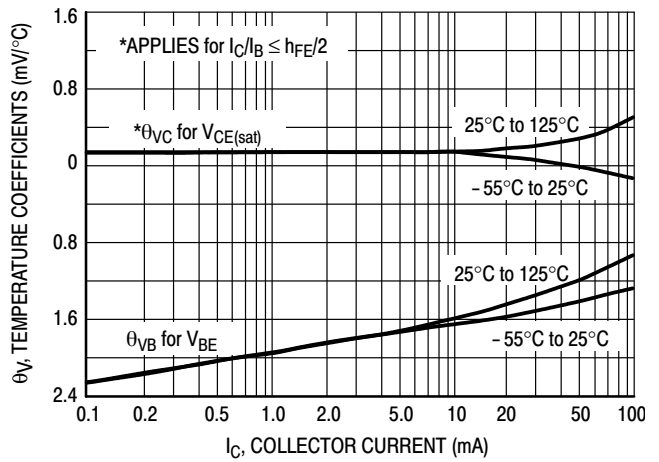

Figure 10. Temperature Coefficients

# BCW30LT1G, SBCW30LT1G

## TYPICAL DYNAMIC CHARACTERISTICS

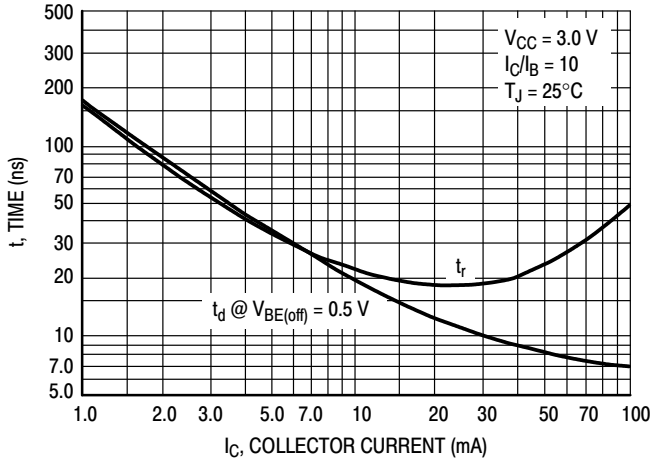

Figure 11. Turn-On Time

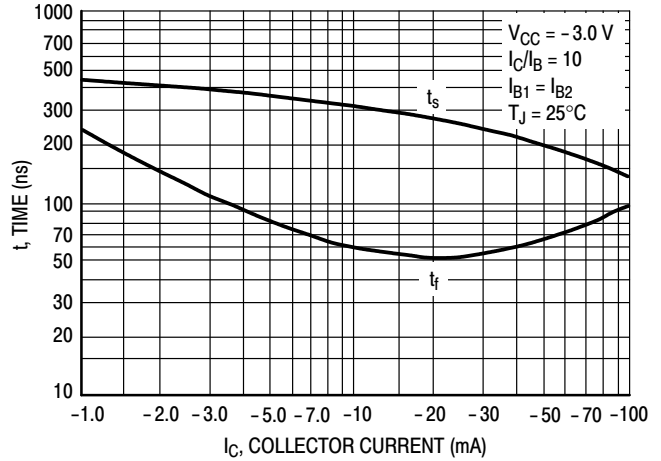

Figure 12. Turn-Off Time

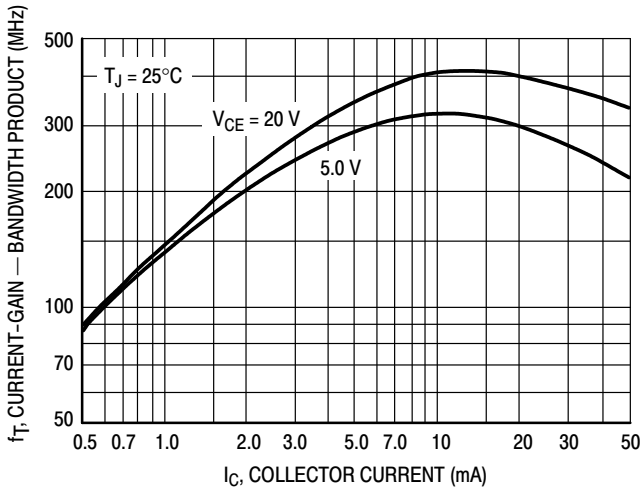

Figure 13. Current-Gain — Bandwidth Product

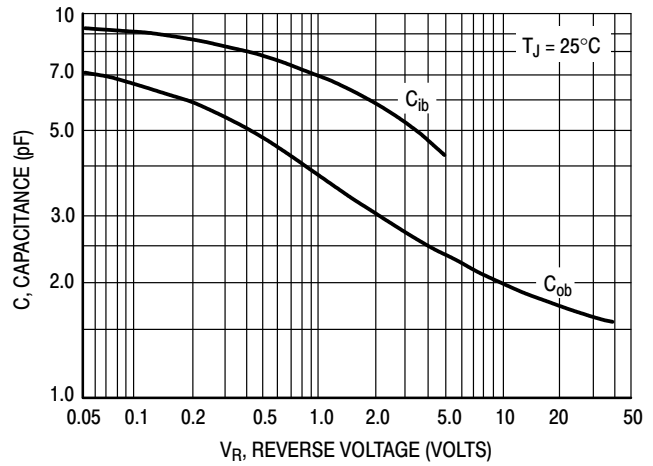

Figure 14. Capacitance

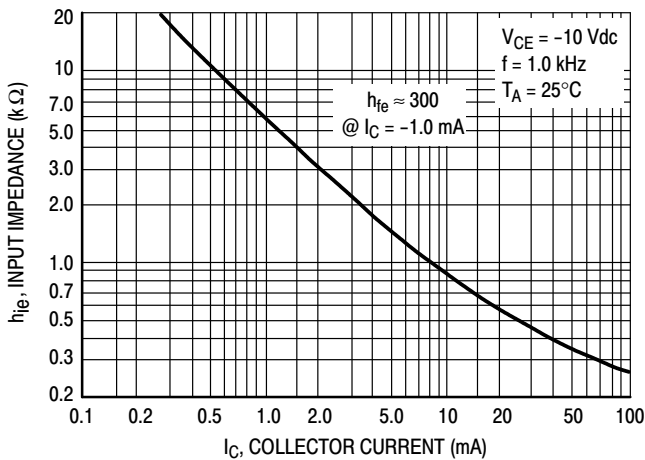

Figure 15. Input Impedance

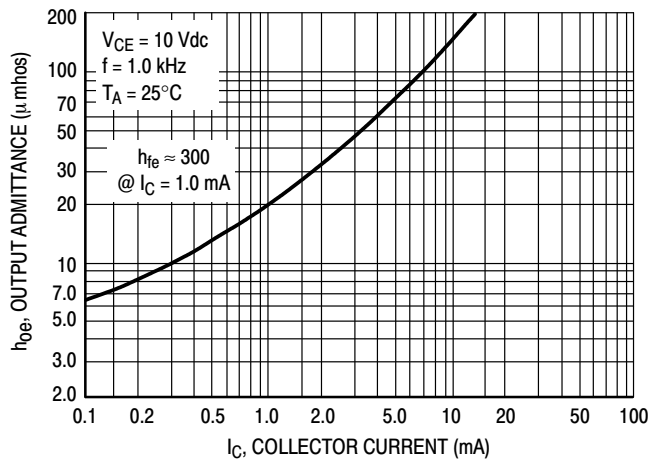

Figure 16. Output Admittance

# BCW30LT1G, SBCW30LT1G

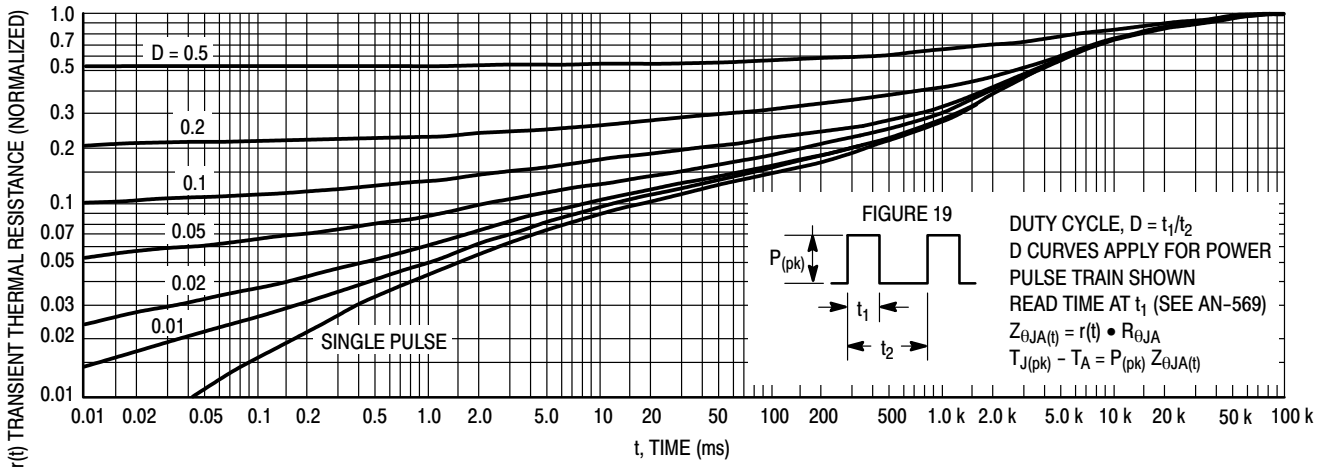

Figure 17. Thermal Response

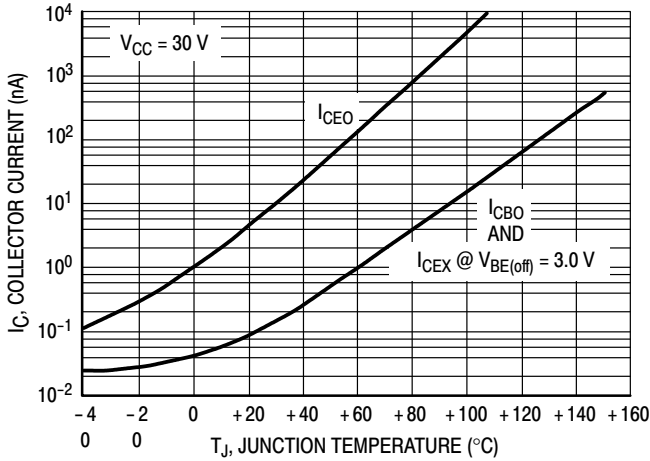

Figure 18. Typical Collector Leakage Current

## DESIGN NOTE: USE OF THERMAL RESPONSE DATA

A train of periodical power pulses can be represented by the model as shown in Figure 19. Using the model and the device thermal response the normalized effective transient thermal resistance of Figure 17 was calculated for various duty cycles.

To find  $Z_{\theta JA(t)}$ , multiply the value obtained from Figure 17 by the steady state value  $R_{\theta JA}$ .

Example:

The BCW29LT1 is dissipating 2.0 watts peak under the following conditions:

$$t_1 = 1.0 \text{ ms}, t_2 = 5.0 \text{ ms} (D = 0.2)$$

Using Figure 17 at a pulse width of 1.0 ms and  $D = 0.2$ , the reading of  $r(t)$  is 0.22.

The peak rise in junction temperature is therefore

$$\Delta T = r(t) \times P_{(pk)} \times R_{\theta JA} = 0.22 \times 2.0 \times 200 = 88^\circ\text{C}.$$

For more information, see AN-569.

# BCW30LT1G, SBCW30LT1G

## PACKAGE DIMENSIONS

SOT-23 (TO-236)  
CASE 318-08  
ISSUE AR

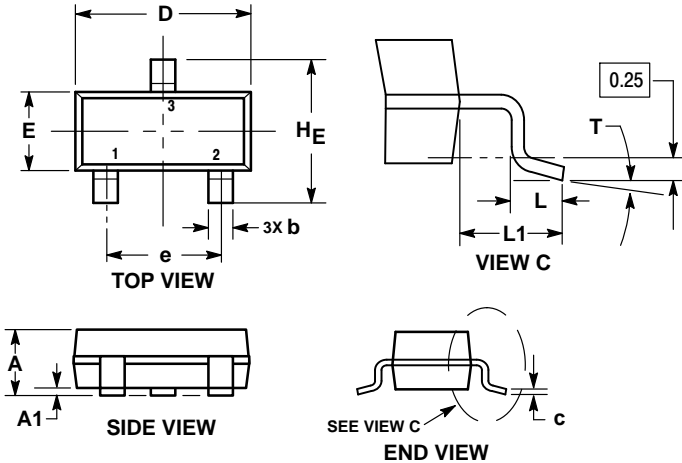

NOTES:

1. DIMENSIONING AND TOLERANCING PER ASME Y14.5M, 1994.
2. CONTROLLING DIMENSION: MILLIMETERS.
3. MAXIMUM LEAD THICKNESS INCLUDES LEAD FINISH. MINIMUM LEAD THICKNESS IS THE MINIMUM THICKNESS OF THE BASE MATERIAL.
4. DIMENSIONS D AND E DO NOT INCLUDE MOLD FLASH, PROTRUSIONS, OR GATE BURRS.

DIM	MILLIMETERS			INCHES		
	MIN	NOM	MAX	MIN	NOM	MAX
A	0.89	1.00	1.11	0.035	0.039	0.044
A1	0.01	0.06	0.10	0.000	0.002	0.004
b	0.37	0.44	0.50	0.015	0.017	0.020
c	0.08	0.14	0.20	0.003	0.006	0.008
D	2.80	2.90	3.04	0.110	0.114	0.120
E	1.20	1.30	1.40	0.047	0.051	0.055
e	1.78	1.90	2.04	0.070	0.075	0.080
L	0.30	0.43	0.55	0.012	0.017	0.022
L1	0.35	0.54	0.69	0.014	0.021	0.027
HE	2.10	2.40	2.64	0.083	0.094	0.104
T	0°	---	10°	0°	---	10°

STYLE 6:

1. BASE
2. EMITTER
3. COLLECTOR

### RECOMMENDED SOLDERING FOOTPRINT\*

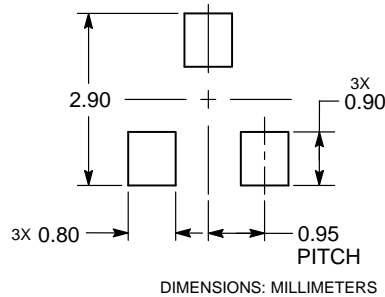

\*For additional information on our Pb-Free strategy and soldering details, please download the ON Semiconductor Soldering and Mounting Techniques Reference Manual, SOLDERRM/D.

ON Semiconductor and are trademarks of Semiconductor Components Industries, LLC dba ON Semiconductor or its subsidiaries in the United States and/or other countries. ON Semiconductor owns the rights to a number of patents, trademarks, copyrights, trade secrets, and other intellectual property. A listing of ON Semiconductor's product/patent coverage may be accessed at [www.onsemi.com/site/pdf/Patent-Marking.pdf](http://www.onsemi.com/site/pdf/Patent-Marking.pdf). ON Semiconductor reserves the right to make changes without further notice to any products herein. ON Semiconductor makes no warranty, representation or guarantee regarding the suitability of its products for any particular purpose, nor does ON Semiconductor assume any liability arising out of the application or use of any product or circuit, and specifically disclaims any and all liability, including without limitation special, consequential or incidental damages. Buyer is responsible for its products and applications using ON Semiconductor products, including compliance with all laws, regulations and safety requirements or standards, regardless of any support or applications information provided by ON Semiconductor. "Typical" parameters which may be provided in ON Semiconductor data sheets and/or specifications can and do vary in different applications and actual performance may vary over time. All operating parameters, including "Typicals" must be validated for each customer application by customer's technical experts. ON Semiconductor does not convey any license under its patent rights nor the rights of others. ON Semiconductor products are not designed, intended, or authorized for use as a critical component in life support systems or any FDA Class 3 medical devices or medical devices with a same or similar classification in a foreign jurisdiction or any devices intended for implantation in the human body. Should Buyer purchase or use ON Semiconductor products for any such unintended or unauthorized application, Buyer shall indemnify and hold ON Semiconductor and its officers, employees, subsidiaries, affiliates, and distributors harmless against all claims, costs, damages, and expenses, and reasonable attorney fees arising out of, directly or indirectly, any claim of personal injury or death associated with such unintended or unauthorized use, even if such claim alleges that ON Semiconductor was negligent regarding the design or manufacture of the part. ON Semiconductor is an Equal Opportunity/Affirmative Action Employer. This literature is subject to all applicable copyright laws and is not for resale in any manner.

### PUBLICATION ORDERING INFORMATION

**LITERATURE FULFILLMENT:**  
Literature Distribution Center for ON Semiconductor  
19521 E. 32nd Pkwy, Aurora, Colorado 80011 USA  
**Phone:** 303-675-2175 or 800-344-3860 Toll Free USA/Canada  
**Fax:** 303-675-2176 or 800-344-3867 Toll Free USA/Canada  
**Email:** [orderlit@onsemi.com](mailto:orderlit@onsemi.com)

**N. American Technical Support:** 800-282-9855 Toll Free  
USA/Canada  
**Europe, Middle East and Africa Technical Support:**  
Phone: 421 33 790 2910  
**Japan Customer Focus Center**  
Phone: 81-3-5817-1050

**ON Semiconductor Website:** [www.onsemi.com](http://www.onsemi.com)  
**Order Literature:** <http://www.onsemi.com/orderlit>

For additional information, please contact your local Sales Representative

# Mouser Electronics

Authorized Distributor

Click to View Pricing, Inventory, Delivery & Lifecycle Information:

[ON Semiconductor:](#)

[SBCW30LT1G](#)