

## Industrial Rotary Position Sensor Bushing Mount Type, Conductive Plastic

**FEATURES**

- Fully sealed for high immunity to environmental damage
- Excellent temperature stability
- Rotational life exceeds 2 million revolutions
- Low cost and wide range of options
- Stainless steel shaft
- Shock to 30 g vibration to 15 g at 10 Hz to 2000 Hz

**QUICK REFERENCE DATA**

|                  |                                |
|------------------|--------------------------------|
| Sensor type      | ROTATIONAL, conductive plastic |
| Output type      | Output by turrets              |
| Market appliance | Industrial                     |
| Dimensions       | 15.81 mm x 17.46 mm            |



**ELECTRICAL SPECIFICATIONS**

| PARAMETER               |                                       |
|-------------------------|---------------------------------------|
| Standard resistance     | 1 kΩ to 100 kΩ                        |
| Capability range        | 200 kΩ                                |
| Resistance tolerance    | ± 20 %                                |
| Linearity               | ± 2 %                                 |
| Power rating            | 1.0 W at 85 °C                        |
| Electrical travel       | 240° ± 4°                             |
| Dielectric withstanding | 500 V <sub>RMS</sub> at 60 Hz minimum |
| Output smoothness       | 0.2 % maximum                         |

**MECHANICAL SPECIFICATIONS**

| PARAMETER           |                                |
|---------------------|--------------------------------|
| Bearing type        | Sleeve                         |
| Mechanical rotation | 250° ± 2°                      |
| Stop strength       | 10 in - lb minimum, 11.5 kg/cm |
| Starting torque     | 3.0 o.z - in maximum, 216 g/cm |
| Running torque      | 3.0 oz. - in maximum, 216 g/cm |

**ORDERING INFORMATION/DESCRIPTION**

| 657   | B                  | F                                      | 0   |   |   | 50 kΩ            | B10              |
|-------|--------------------|--|---|---|---|------------------|------------------|
| MODEL | STYLE              | SHAFT OPTIONS                          | SHAFT BUSHING OPTIONS   |   |   | TOTAL RESISTANCE | PACKAGING        |
|       | <b>B</b> : Bushing | <b>R</b> - Round<br><b>F</b> - Flatted | <br>Shaft length<br><b>0</b> - 0.875" FMS<br><b>1</b> - 0.625" FMS<br><b>2</b> - 1.000" FMS<br><b>3</b> - 1.250" FMS | <br>Bushing length<br>0.375" FMS<br>0.250" FMS<br>0.500" FMS<br>0.750" FMS | <br>Flat<br>0.440"<br>0.315"<br>0.440"<br>0.440" |                  | Box of 10 pieces |

**SAP PART NUMBERING GUIDELINES**

| 657B  | R                | 1                         | 103         | BO10      |
|-------|------------------|---------------------------|-------------|-----------|
| MODEL | END SHAFT        | SHAFT AND BUSHING OPTIONS | OHMIC VALUE | PACKAGING |
|       | <b>R</b> : Round | (see above)               |             |           |

**DIMENSIONS** in inches (millimeters)

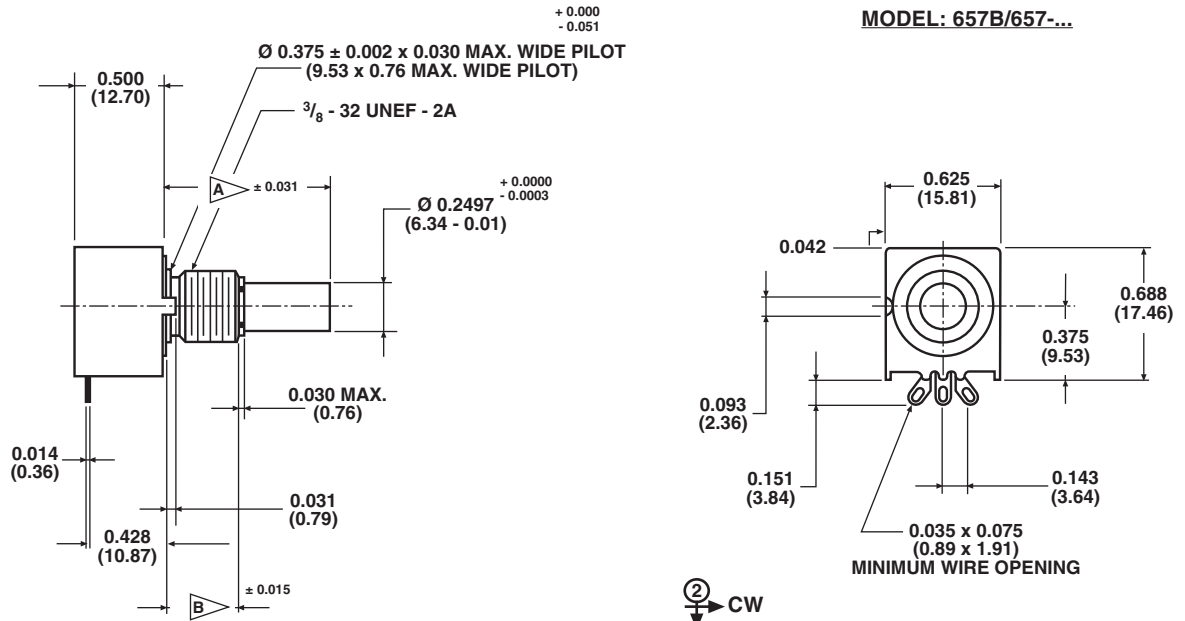

MODEL: 657B/657-...

DECIMALS: XX ± 0.01 INCHES (± 0.25 mm)  
XX ± 0.005 INCHES (± 0.13 mm) ANGLES: ± 2°

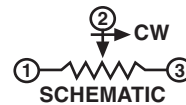

**SHAFT FLAT AND PHASING DIAGRAM**

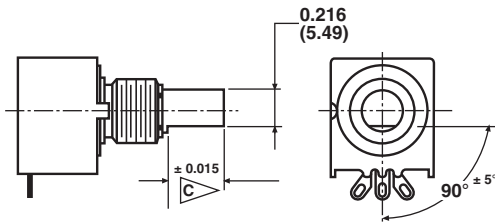

WITH SHAFT FLAT POSITIONED AS SHOWN, OUTPUT RATIO  
TO BE e/E = 0.50 ± 0.02

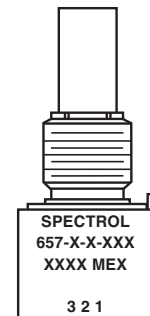

**STANDARD RESISTANCE VALUES**

| CODE | RESISTANCE (Ω) |
|------|----------------|
| 102  | 1K             |
| 202  | 2K             |
| 502  | 5K             |
| 103  | 10K            |
| 203  | 20K            |
| 503  | 50K            |
| 104  | 100K           |

**MATERIAL SPECIFICATIONS**

|         |   |
|---------|---|
| Shaft   | Stainless steel                         |
| Bushing | Nickel plated brass                     |
| Housing | Thermoplastic                           |
| Element | Conductive plastic on alumina substrate |

**ENVIRONMENTAL SPECIFICATIONS**

|                               |   |
|-------------------------------|---|
| Rotational life               | 2 million revolutions   |
| Vibration                     | 15 g at 10 Hz to 2000 Hz  |
| Operating temperature         | -40 °C to +125 °C   |
| Storage temperature           | -55 °C to +150 °C   |
| Temperature coefficient       | ± 600 ppm/°C  |
| Shock                         | 30 g  |
| Resistant to solder heat      | 350 °C for 5 s  |
| Moisture resistance IP rating | Sealed construction<br>IP67* application to provide protection for wiring terminals |

**Note**

- Nothing stated herein shall be construed as a guarantee of quality or durability.

**MARKING**

|                     |  |
|---------------------|--|
| Unit identification | Vishay Spectrol, part number, data code, country of origin and terminal designation. Example of a marking for a standard part: 657-2-0-102 |
|---------------------|--|



## **Disclaimer**

ALL PRODUCT, PRODUCT SPECIFICATIONS AND DATA ARE SUBJECT TO CHANGE WITHOUT NOTICE TO IMPROVE RELIABILITY, FUNCTION OR DESIGN OR OTHERWISE.

Vishay Intertechnology, Inc., its affiliates, agents, and employees, and all persons acting on its or their behalf (collectively, "Vishay"), disclaim any and all liability for any errors, inaccuracies or incompleteness contained in any datasheet or in any other disclosure relating to any product.

Vishay makes no warranty, representation or guarantee regarding the suitability of the products for any particular purpose or the continuing production of any product. To the maximum extent permitted by applicable law, Vishay disclaims (i) any and all liability arising out of the application or use of any product, (ii) any and all liability, including without limitation special, consequential or incidental damages, and (iii) any and all implied warranties, including warranties of fitness for particular purpose, non-infringement and merchantability.

Statements regarding the suitability of products for certain types of applications are based on Vishay's knowledge of typical requirements that are often placed on Vishay products in generic applications. Such statements are not binding statements about the suitability of products for a particular application. It is the customer's responsibility to validate that a particular product with the properties described in the product specification is suitable for use in a particular application. Parameters provided in datasheets and / or specifications may vary in different applications and performance may vary over time. All operating parameters, including typical parameters, must be validated for each customer application by the customer's technical experts. Product specifications do not expand or otherwise modify Vishay's terms and conditions of purchase, including but not limited to the warranty expressed therein.

Except as expressly indicated in writing, Vishay products are not designed for use in medical, life-saving, or life-sustaining applications or for any other application in which the failure of the Vishay product could result in personal injury or death. Customers using or selling Vishay products not expressly indicated for use in such applications do so at their own risk. Please contact authorized Vishay personnel to obtain written terms and conditions regarding products designed for such applications.

No license, express or implied, by estoppel or otherwise, to any intellectual property rights is granted by this document or by any conduct of Vishay. Product names and markings noted herein may be trademarks of their respective owners.