

## General specifications

### Layout

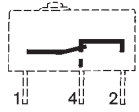

### Components

#### Material

- Case : polyester UL 94 VO
- Button : glass-filled polyamide
- Contacts : AgNi, gold-plated AgNi (dual-current)
- Terminals : copper-nickel

#### Actuators

- flat : stainless steel
- roller : stainless steel with polyamide roller

Approvals: NF - UL - cUL

### Operating curve

For type 83 170 0

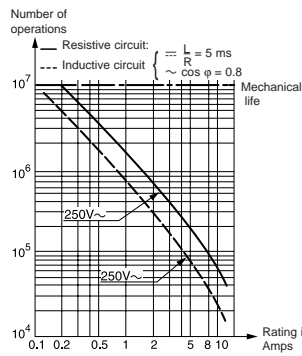

For type 83 170 4

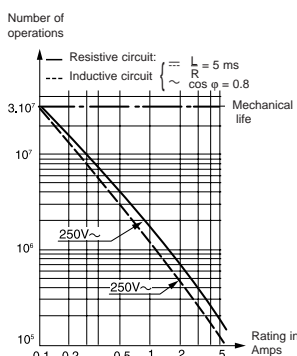

For type 83 170 9

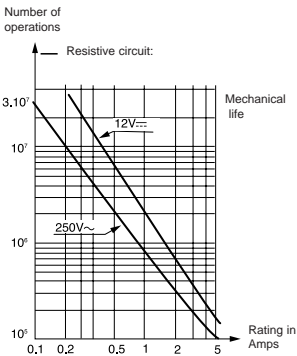

Model 83 170 9 is designed to operate equally well on dual-current (1 mA 4 V minimum) or medium-current (5 A maximum) circuits. However, a given product should only be used to switch one type of circuit during its working life.

## Types

Part numbers for standard products (no lever) terminal type	
	1
	2
	3

### Features

#### Electrical characteristics

	Nominal	A
Current rating at 250 V		
	Thermal	A

#### Mechanical characteristics

Operating force - max.	N (oz.)
Release force - min.	N (oz.)
Total travel force - max.	N (oz.)
Permitted overtravel force - max.	N (oz.)
Maximum rest position	mm (in.)
Tripping point	mm (in.)
Differential travel	mm (in.)
Overtravel - min.	mm (in.)
Ambient operating temperature	°C
Mechanical endurance	Operations
Contact gap	mm (in.)
Weight	g (oz.)

#### Contact type

- C** (Form C) SPDT
- B** (Form B) SPNC not available in PC terminals
- A** (Form A) SPNO not available in PC terminals

#### Connections

## Actuators and mounting positions

### Part numbers for standard actuators

Actuators – Length	mm (in.)
--------------------	----------

### Mounting positions

Coefficient	
Tripping point	mm (in.)

### Mounting positions

Except where otherwise indicated, actuators are supplied unmounted. For factory mounting, specify mounting position L or R.

- **To calculate force** : take the force quoted for the switch and divide by the coefficient given in the table.
- **To calculate travel** : take the travel quoted for the switch and multiply by the same coefficient.

### Mounting accessories for PCB mounting: 5 / 6 / 7 / 8

See page 3/9.

## Other information

For other forces, actuators, connections and temperatures, please consult us.

Normally stocked items

Catalog products produced to order

Products and specifications subject to change without notice.

Order/Technical Support – Tel: (800) 677-5311 / FAX: (800) 677-3865 / www.crouzet-usa.com

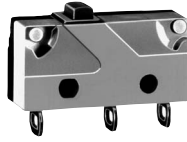

1

83170.0	83170.4	83170.9	83170.4 SP 4967	83170.4	83170.9
831700C1.0	831704C1.0	831709C1.0	831704C2.MBSP	831704C1.MB	831709C1.MB
831700C2.0	831704C2.0	831709C2.0	831704C3.MBSP	831704C2.MB	831709C2.MB
831700C3.0	831704C3.0	831709C3.0	831704C1.MBSP	831704C3.MB	831709C3.MB
High current	Standard	Low current	High force	Standard	Low current
10	5	0.1	5	5	0.1
12.5	6		6	6	
1.5 (5.3)	0.6 (2.2)	0.6 (2.2)	1.5 (5.3)	0.6 (2.2)	0.6 (2.2)
0.3 (1)	0.1 (.04)	0.1 (.04)	0.3 (1)	0.1 (.04)	0.1 (.04)
1.8 (6.3)	1 (3.5)	1 (3.5)	1.8 (6.3)	1 (3.5)	1 (3.5)
10 (35.3)	10 (35.3)	10 (35.3)	10 (35.3)	10 (35.3)	10 (35.3)
9.2 (.36)	9.2 (.36)	9.2 (.36)	10.8 (.425)	10.8 (.425)	10.8 (.425)
8.4 <sup>+0.3</sup> (.33 <sup>+0.01</sup> )	8.4 <sup>+0.3</sup> (.33 <sup>+0.01</sup> )	8.4 <sup>+0.3</sup> (.33 <sup>+0.01</sup> )	9.9 <sup>+0.3</sup> (.39 <sup>+0.01</sup> )	9.9 <sup>+0.3</sup> (.39 <sup>+0.01</sup> )	9.9 <sup>+0.3</sup> (.39 <sup>+0.01</sup> )
0.15 (.006)	0.15 (.006)	0.15 (.006)	0.15 (.006)	0.15 (.006)	0.15 (.006)
0.5 (.02)	0.5 (.02)	0.5 (.02)	0.5 (.02)	0.5 (.02)	0.5 (.02)
-20 to130 (-4 to 266)	-20 to130 (-4 to 266)	-20 to130 (-4 to 266)	-20 to130 (-4 to 266)	-20 to130 (-4 to 266)	-20 to130 (-4 to 266)
10 <sup>7</sup>	3.10 <sup>7</sup>	3.10 <sup>7</sup>	10 <sup>6</sup>	10 <sup>6</sup>	10 <sup>6</sup>
0.4 (.016)	0.4 (.016)	0.4 (.016)	0.4 (.016)	0.4 (.016)	0.4 (.016)
1.7 (.06)	1.7 (.06)	1.7 (.06)	1.7 (.06)	1.7 (.06)	1.7 (.06)

2

C	C	C	C	C	C
B	B	B	B	B	B
A	A	A	A	A	A

3

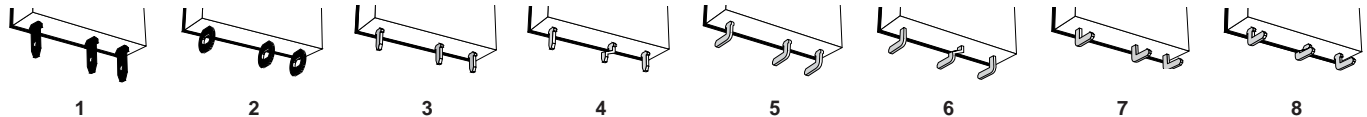

4

A 79 253 327	B 79 253 326	C 79 253 328	E 79 218 454	F 79 253 329
Flat 170A R18.3 (.72)	Flat 170A R24 (.94)	Flat 170A R41 (1.61)	Roller 170E R20 (.79)	Dummy roller 170F R19.5 (.77)
L 3 10.4 <sup>+1.2</sup> (.41 <sup>+0.05</sup> )	L 4 11.1 <sup>+1.2</sup> (.44 <sup>+0.05</sup> )	L 7 13.2 <sup>+2.5</sup> (.52 <sup>+1</sup> )	L 3 15.4 <sup>+1.2</sup> (.61 <sup>+0.05</sup> )	L 3 13 <sup>+1.2</sup> (.51 <sup>+0.05</sup> )
R 1.5 9.2 <sup>+0.6</sup> (.36 <sup>+0.24</sup> )	R 2 9.6 <sup>+0.6</sup> (.38 <sup>+0.24</sup> )	R 3.5 10.7 <sup>+1.2</sup> (.42 <sup>+0.05</sup> )	R 1.5 14.5 <sup>+0.6</sup> (.57 <sup>+0.24</sup> )	R 1.5 12 <sup>+0.6</sup> (.47 <sup>+0.24</sup> )

D 79 218 491	L 79 218 493
Screw 170D R20 (.79)	Transverse roller 170L R20 (.79)
Characteristics available upon request.	

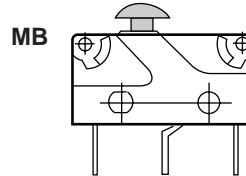

Ø No Actuator

5

To order please specify :

1 Switch Type	2 Contact Type	3 Connection	4 Actuators	5 Actuator Position
831700 831704 831709	A B C	1 5 2 6 3 7 4 8	A B C D Ø MB MB SP4967	L - Left (Standard) R - Right
To order actuators separately, use the 8 digit P/N		Example P/N is 831700 SPDT solder terminals "C" actuator mounted on the left.		

Products and specifications subject to change without notice.

Order/Technical Support – Tel: (800) 677-5311 / FAX: (800) 677-3865 / www.crouzet-usa.com

# Subminiature Switches DIN 41635 B

## Dimensions

### 83 170 Asymmetric

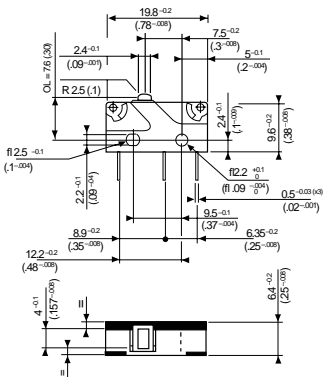

### 83 170 Symmetric

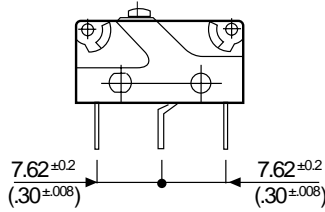

### 83 170 with MB Button

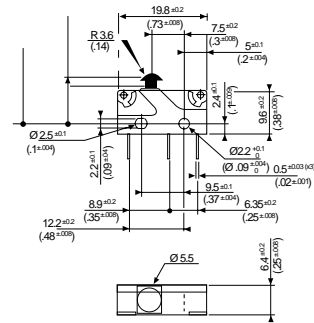

Mounting by M2 screws  
Torque : 2 cm daN

mm (in)

## Connections

- 2  
Solder
- 1  
.11x.02 Quick Connects
- 3-4  
Straight PCB
- 5-6  
Side Output PCB Rear
- 7-8  
Side Output PCB Front

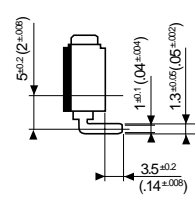
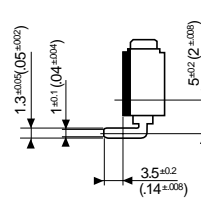
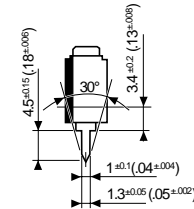
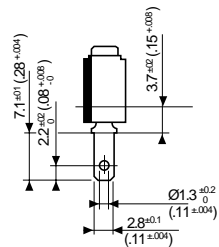
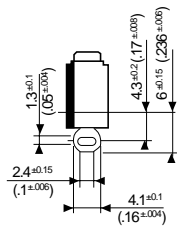

## Printed circuit board mounting

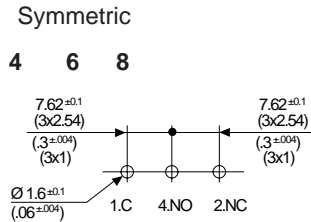
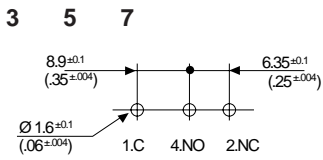

mm (in)

Products and specifications subject to change without notice.

Order/Technical Support – Tel: (800) 677-5311 / FAX: (800) 677-3865 / www.crouzet-usa.com

## Actuators

### Actuator mounting positions

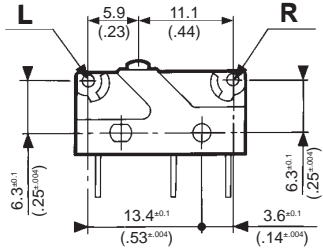

A B C

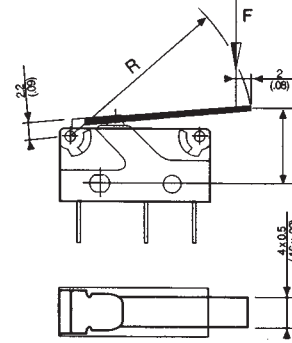

TP (Tripping Point)  
Refer to pages 3/6 & 3/7.

E

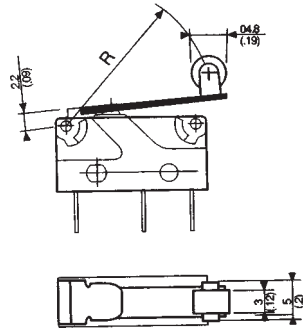

F

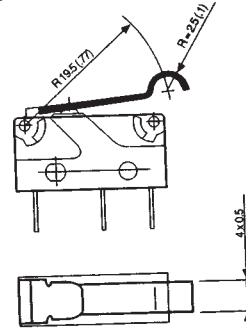

mm (in.)

## Mounting accessories

### Mounting pins

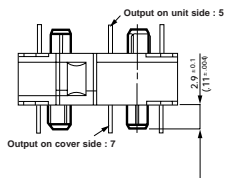

mm (in.)

Products and specifications subject to change without notice.

Order/Technical Support – Tel: (800) 677-5311 / FAX: (800) 677-3865 / www.crouzet-usa.com

# Mouser Electronics

Authorized Distributor

Click to View Pricing, Inventory, Delivery & Lifecycle Information:

## Crouzet:

[831708C5.AL](#) [831709C1.0](#) [831709C1.EL](#) [831709C1.MB](#) [831709C2.0](#) [831709C2.AL](#) [831709C2.9785.10](#)  
[831709C7.MB](#) [831709C2.BL](#) [831709C2.EL](#) [831709B1.0](#) [831709B2.0](#) [831709C1.AL](#) [831709C1.BL](#) [831709C1.CL](#)  
[831709C1.79250083L](#) [831709C3.AL](#) [831709C3.FR](#) [831709C4.0](#) [831709C7.0](#) [831709C8.0](#) [831709A1.BL](#)  
[831709A2.0](#) [831709B2.BL](#) [831709C2.9785.30](#) [831709C2.CL](#) [831709C2.MB](#) [831709C3.0](#) [831709C2.CR](#)  
[831709C2.DL](#) [831709C2.ER](#) [831709C2.FL](#) [831709C5.0](#) [831709A1.0](#)