





SMT POWER INDUCTORS

Flat Coils - PG0083 Series



-  **Height:** 4.2mm Max
-  **Footprint:** 6.8mm x 6.8mm Max
-  **Current Rating:** up to 17.5A
-  **Inductance Range:** 0.32μH to 3.76μH

Electrical Specifications @ 25°C — Operating Temperature -40°C to +95°C¹

Part ⁸ Number	Inductance @I _{rated} ² (μH TYP)	I _{rated} ³ (A)	DCR (mΩ)		Inductance @0A _{dc} (μH ±25%)	Saturation ⁴ Current I _{sAT} (A)	Heating ⁵ Current I _{bc} (A)	Core Loss ⁶ Factor	
			TYP	MAX				(K1)	(K2)
PG0083.401	0.32	17.5	3.0	3.2	0.40	27	17.5	2.25E-10	85.4
PG0083.601	0.48	15	4.5	4.8	0.60	21	15	2.25E-10	99.7
PG0083.102	0.80	12	6.6	7.2	1.0	17	12	2.25E-10	135.9
PG0083.182	1.44	8.0	15.6	16.0	1.8	13	8.0	2.25E-10	179.4
PG0083.232	1.84	7.0	17.5	18.0	2.3	11.5	7.5	2.25E-10	202.2
PG0083.332	2.64	5.5	26.6	27.5	3.3	9.5	5.8	2.25E-10	234.9
PG0083.472	3.76	4.5	36.6	38.0	4.7	8.0	4.5	2.25E-10	281.1

NOTE: To order RoHS compliant part, add the suffix "NL" to the part number (i.e. PG0083.401 becomes PG0083.401NL and PG0083.401T becomes PG0083.401NLT).

Mechanical

Schematic

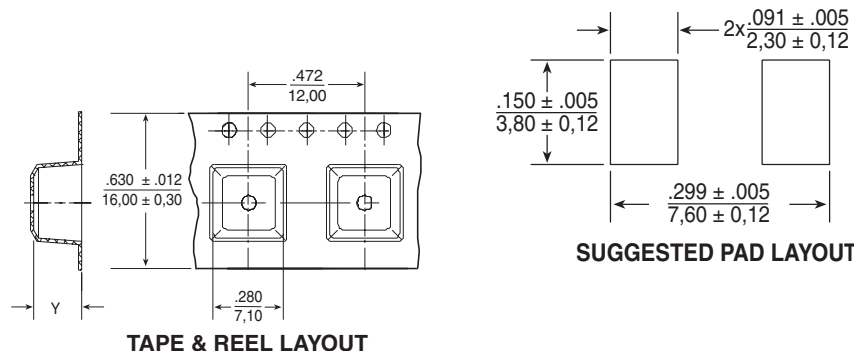
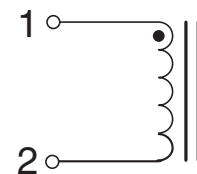
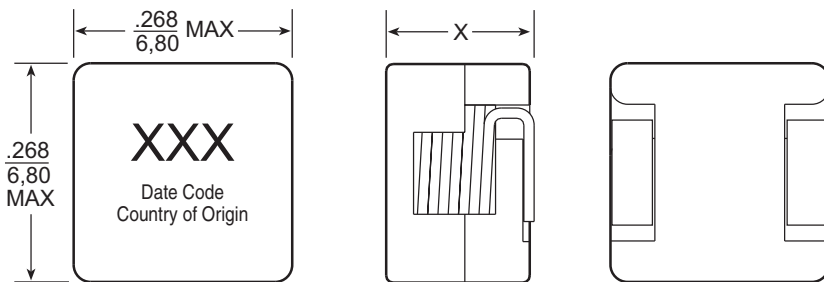

Part No.	Max. Height "X" (in./mm)
PG0083.401	.165/4,20
PG0083.601	.165/4,20
PG0083.102	.165/4,20
PG0083.182	.157/4,00
PG0083.232	.157/4,00
PG0083.332	.157/4,00
PG0083.472	.157/4,00

Dimensions: $\frac{\text{Inches}}{\text{mm}}$
 Unless otherwise specified, all tolerances are $\pm \frac{.010}{0,25}$

Weight.....1.0 grams
 Tape & Reel1000/reel
 T&R Height0.189/4,80
 ("Y" - in./mm)

SMT POWER INDUCTORS

Flat Coils - PG0083 Series



Notes from Tables

- The temperature of the component (ambient plus temperature rise) must be within the specified operating temperature range.
- Inductance at I_{rated} is a typical inductance value for the component taken at rated current.
- The rated current listed is the lower of the saturation current @ 25°C or the heating current.
- The saturation current, I_{sat} , is the current at which the component inductance drops by 20% (typical) at an ambient temperature of 25°C. This current is determined by placing the component in the specified ambient environment and applying a short duration pulse current (to eliminate self-heating effects) to the component.
- The heating current, I_{hc} , is the DC current required to raise the component temperature by approximately 40°C. The heating current is determined by mounting the component on a typical PCB and applying current for 30 minutes. The temperature is measured by placing the thermocouple on top of the unit under test. Take note that the component's performance varies depending on the system condition. It is suggested that the component be tested at the system level, to verify the temperature rise of the component during system operation.
- Core loss approximation is based on published core data:
Core Loss = $K1 * (f)^{1.035} * (K2\Delta I)^{2.263}$
Where: Core Loss = in Watts
 f = switching frequency in kHz
K1 & K2 = core loss factors
 ΔI = delta I across the component in Ampere
K2ΔI = one half of the peak to peak flux density across the component in Gauss
- Unless otherwise specified, all testing is made at 100kHz, 0.1Vac.
- Optional Tape & Reel packaging can be ordered by adding a "T" suffix to the part number (i.e. PG0083.472 becomes PG0083.472T). Pulse complies to industry standard tape and reel specification EIA481.

Inductance vs Current Characteristics

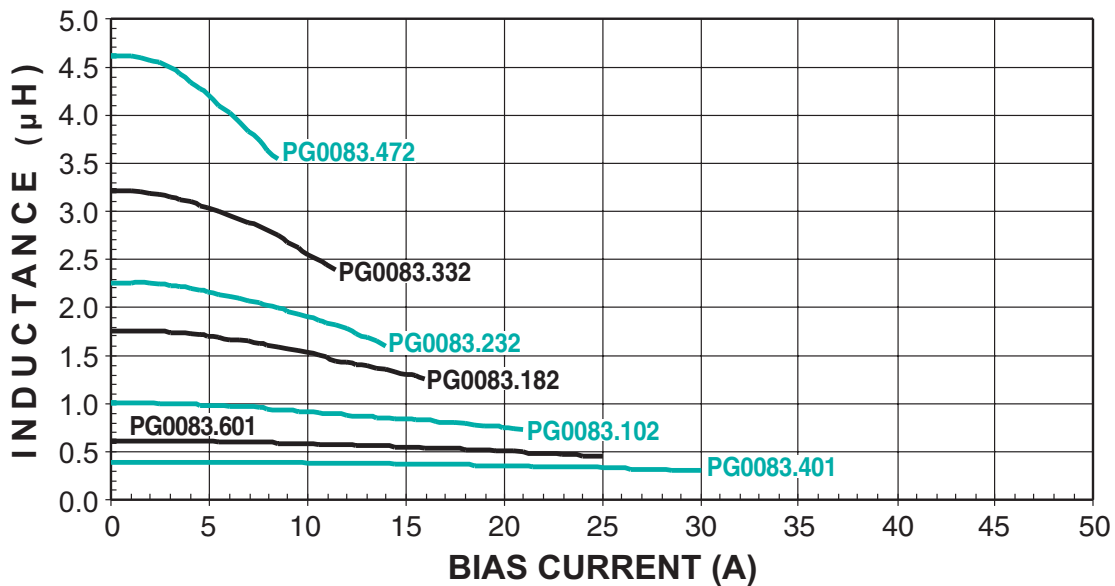

Mouser Electronics

Authorized Distributor

Click to View Pricing, Inventory, Delivery & Lifecycle Information:

Pulse:

[PG0083.102T](#) [PG0083.182T](#) [PG0083.472T](#) [PG0083.102NLT](#) [PG0083.232NLT](#) [PG0083.601NLT](#) [PG0083.401NLT](#)
[PG0083.472NLT](#) [PG0083.332NLT](#) [PG0083.182NLT](#)