

## Broadband CATV Single Ended 5-Way Active Splitter 50 - 1100 MHz

Rev. V1

### Features

- 5-Way Splitter
- Single Ended Input and Outputs
- 3.5 dB Gain
- +15 dBmV /Channel Input
- 3.8 dB Noise Figure
- Single +5 Volt Supply
- Lead-Free 3 mm 12-Lead PQFN Package
- Halogen-Free “Green” Mold Compound
- RoHS\* Compliant and 260°C Reflow Compatible

### Description

The MAAM-008821 CATV 5-way active splitter is a GaAs MMIC which exhibits low noise figure and distortion in a lead-free 3mm 12-lead PQFN plastic package. The design features 75 Ω inputs and outputs.

The MAAM-008821 is ideally suited for multi-tuner set top boxes, home gateways, and other broadband internet based appliances.

The MAAM-008821 is fabricated using M/A-COM Technology’s pHEMT process to realize low noise and low distortion. The process features full passivation for robust performance and reliability.

### Ordering Information <sup>1,2</sup>

Part Number	Package
MAAM-008821-TR1000	1000 piece reel
MAAM-008821-TR3000	3000 piece reel
MAAM-008821-001SMB	Sample Test Board

1. Reference Application Note M513 for reel size information.
2. All sample boards include 5 loose parts.

### Functional Schematic

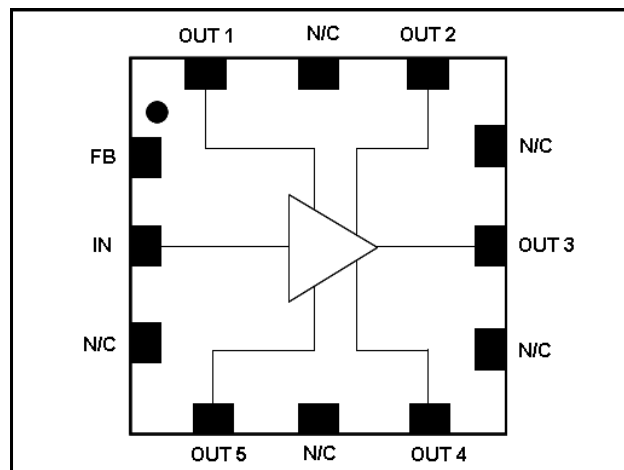

### Pin Configuration

Pin No.	Pin Name	Description
1	FB	Feedback/Bias
2	IN	RF Input
3	N/C	No Connection
4	OUT5	RF Output 5
5	N/C	No Connection
6	OUT4	RF Output 4
7	N/C	No Connection
8	OUT3	RF Output 3
9	N/C	No Connection
10	OUT2	RF Output 2
11	N/C	No Connection
12	OUT1	RF Output 1
13	Paddle <sup>3</sup>	RF and DC Ground

3. The exposed pad centered on the package bottom must be connected to RF and DC ground.

\* Restrictions on Hazardous Substances, European Union Directive 2002/95/EC.

## Broadband CATV Single Ended 5-Way Active Splitter 50 - 1100 MHz

Rev. V1

**Electrical Specifications: Freq. 50 - 1000 MHz,  $T_A = 25^\circ\text{C}$ ,  $V_{DD} = +5\text{ Volts}$ ,  $Z_0 = 75\ \Omega$**

Parameter	Test Conditions	Units	Min.	Typ.	Max.
Gain	IN to All Outputs	dB	2	3.5	4
Gain Flatness	IN to All Outputs	dB	-	1.0	1.2
Noise Figure	IN to All Outputs	dB	-	3.8	-
Input Return Loss	IN	dB	-	15	-
Output Return Loss	All Outputs	dB	-	12	-
Composite Triple Beat, CTB	132 channels, +15 dBmV/channel at the input	dBc	-	-70	-
Composite Second Order, CSO	132 channels, +15 dBmV/channel at the input	dBc	-	-60	-
Reverse Isolation	All Outputs to IN	dB	-	30	-
Output to Output Isolation	Isolation between all RF outputs	dB	-	20	-
Output Power at 1dB Compression, P1dB	IN to All Outputs	dB	-	9	-
Output 3rd Order Intercept Point, OIP3	500 MHz, 2-tone, 6 MHz spacing, -15 dBm Pout	dBm	-	24	-
Output 2nd Order Intercept Point, OIP2	500 MHz, 2-tone, 6 MHz spacing, -15 dBm Pout	dBm	-	48	-
$I_{DD}$	$V_{DD} = +5\text{ Volts}$	mA	-	120	150

### Absolute Maximum Ratings <sup>4,5,6</sup>

Parameter	Absolute Maximum
Max Input Power	+12 dBm
Vbias	+10.0 V
Operating Temperature	-20°C to +85°C
Junction Temperature <sup>7</sup>	150°C
Storage Temperature	-65°C to +150°C

4. Exceeding any one or combination of these limits may cause permanent damage to this device.
5. M/A-COM Technology does not recommend sustained operation near these survivability limits.
6. These operating conditions will ensure MTTF >  $1 \times 10^6$  hours.
7. Junction Temperature ( $T_J$ ) =  $T_C + \Theta_{jc} * (V * I)$   
Typical thermal resistance ( $\Theta_{jc}$ ) = 77° C/W.
  - a) For  $T_C = 25^\circ\text{C}$ ,  
 $T_J = 71^\circ\text{C} @ 5\text{ V}, 120\text{ mA}$
  - b) For  $T_C = 85^\circ\text{C}$ ,  
 $T_J = 127^\circ\text{C} @ 5\text{ V}, 110\text{ mA}$

### Handling Procedures

Please observe the following precautions to avoid damage:

### Static Sensitivity

Gallium Arsenide Integrated Circuits are sensitive to electrostatic discharge (ESD) and can be damaged by static electricity. Proper ESD control techniques should be used when handling these devices. An external protection circuit using an inexpensive anti-parallel diode pair can be used to protect the IC.

Please reference application note AN3028 on <http://www.macomtech.com> for further detail.



### Typical Performance Curves

**Gain to 1100 MHz**  
Typical All Outputs

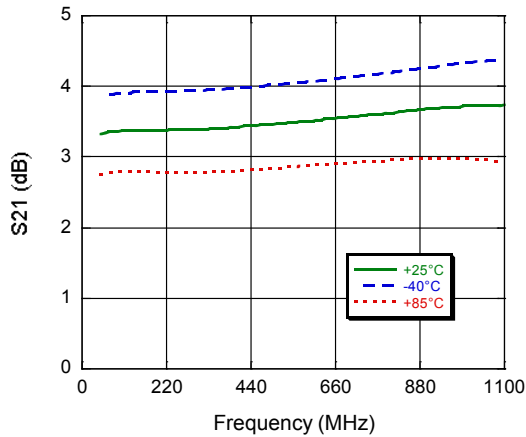

**Gain to 3000 MHz**  
Typical All Outputs

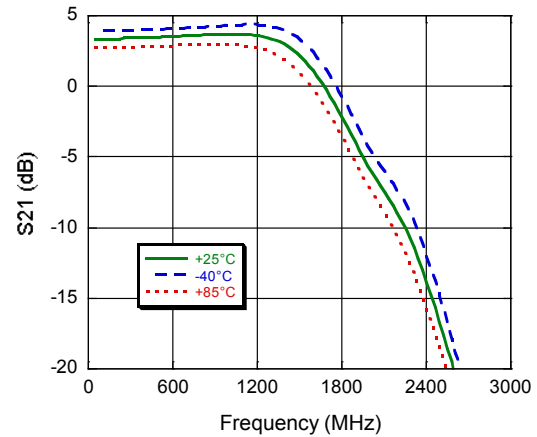

**Input Return Loss**

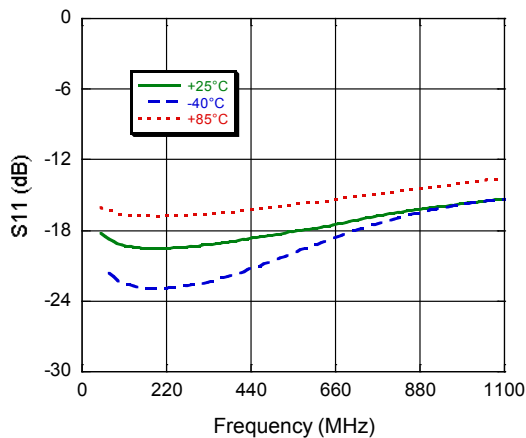

**Output Return Loss**  
Typical All Outputs

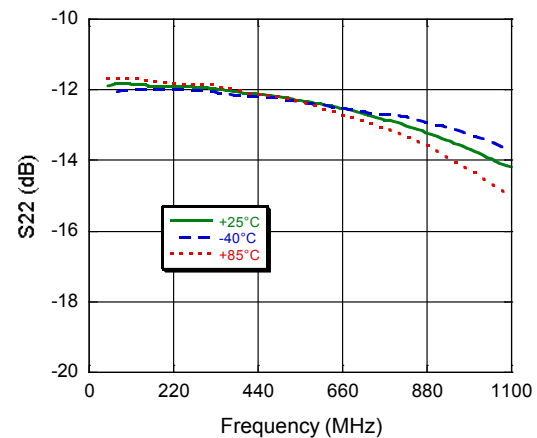

## Broadband CATV Single Ended 5-Way Active Splitter 50 - 1100 MHz

Rev. V1

### Typical Performance Curves

**OUT-OUT Isolation to 1100 MHz**  
Typical Between All Outputs

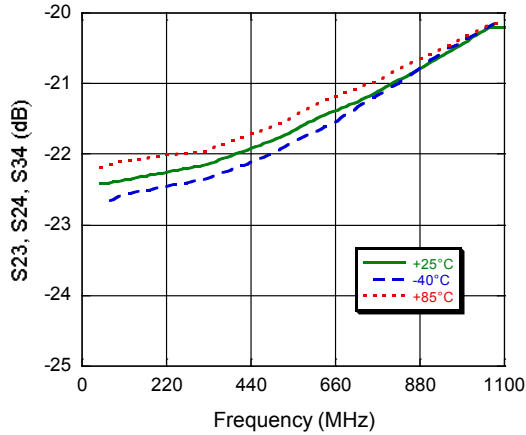

**OUT-OUT Isolation to 3000 MHz**  
Typical Between All Outputs

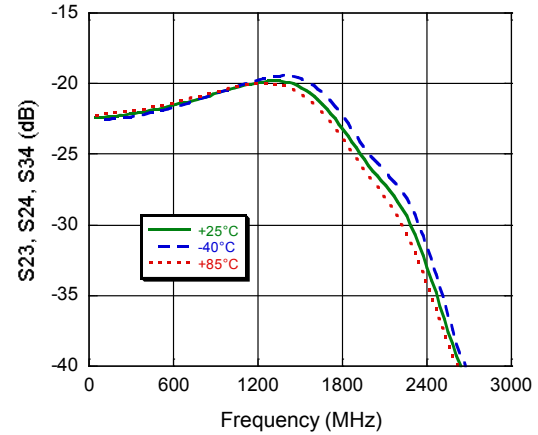

**Noise Figure**  
Typical All Outputs

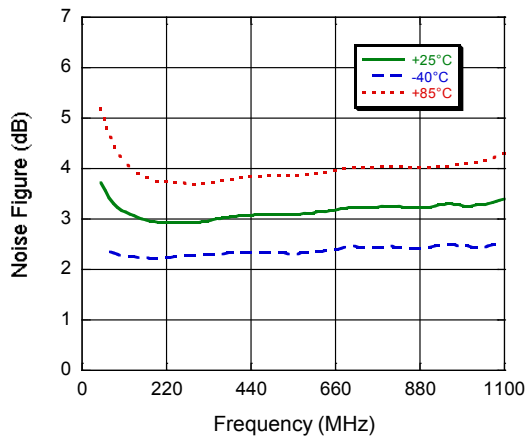

**Reverse Isolation to 3000 MHz**  
Typical From All Outputs to Input

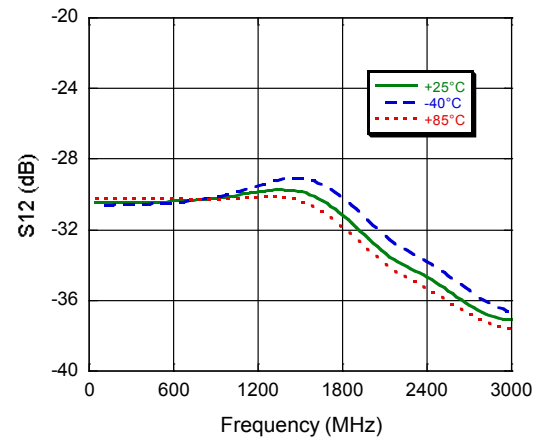

## Broadband CATV Single Ended 5-Way Active Splitter 50 - 1100 MHz

Rev. V1

### Lead-Free 3 mm 12-Lead PQFN<sup>†</sup>

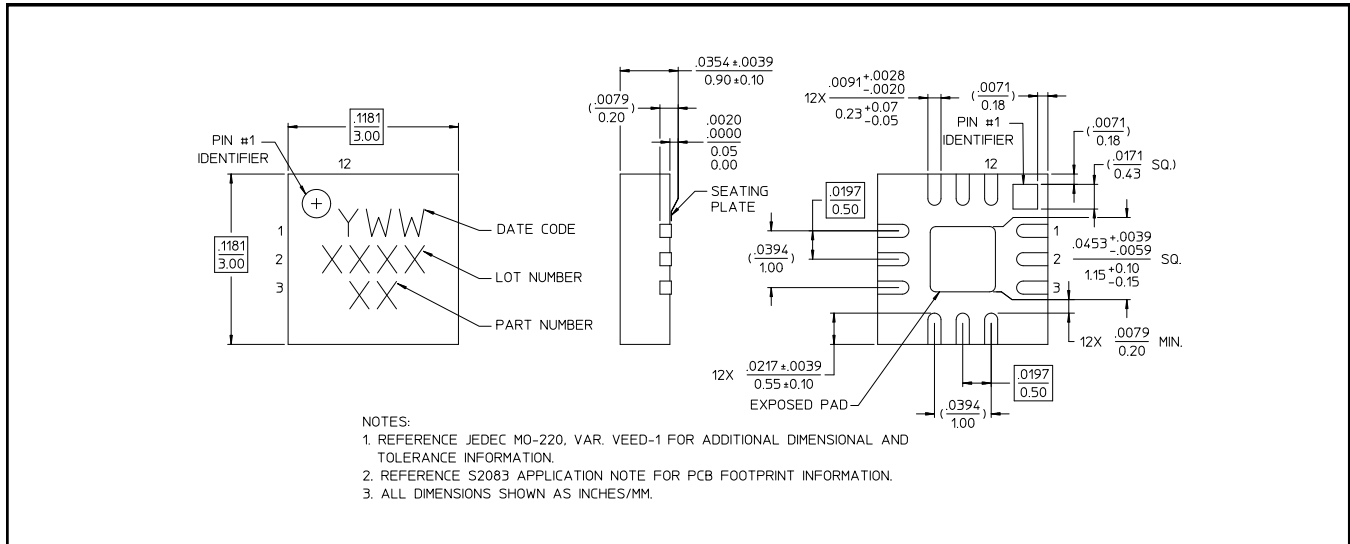

<sup>†</sup> Reference Application Note M538 for lead-free solder reflow recommendations.  
Meets JEDEC moisture sensitivity level 1 requirements.  
Plating is 100% matte tin over copper.

M/A-COM Technology Solutions Inc. All rights reserved.

Information in this document is provided in connection with M/A-COM Technology Solutions Inc ("MACOM") products. These materials are provided by MACOM as a service to its customers and may be used for informational purposes only. Except as provided in MACOM's Terms and Conditions of Sale for such products or in any separate agreement related to this document, MACOM assumes no liability whatsoever. MACOM assumes no responsibility for errors or omissions in these materials. MACOM may make changes to specifications and product descriptions at any time, without notice. MACOM makes no commitment to update the information and shall have no responsibility whatsoever for conflicts or incompatibilities arising from future changes to its specifications and product descriptions. No license, express or implied, by estoppel or otherwise, to any intellectual property rights is granted by this document.

THESE MATERIALS ARE PROVIDED "AS IS" WITHOUT WARRANTY OF ANY KIND, EITHER EXPRESS OR IMPLIED, RELATING TO SALE AND/OR USE OF MACOM PRODUCTS INCLUDING LIABILITY OR WARRANTIES RELATING TO FITNESS FOR A PARTICULAR PURPOSE, CONSEQUENTIAL OR INCIDENTAL DAMAGES, MERCHANTABILITY, OR INFRINGEMENT OF ANY PATENT, COPYRIGHT OR OTHER INTELLECTUAL PROPERTY RIGHT. MACOM FURTHER DOES NOT WARRANT THE ACCURACY OR COMPLETENESS OF THE INFORMATION, TEXT, GRAPHICS OR OTHER ITEMS CONTAINED WITHIN THESE MATERIALS. MACOM SHALL NOT BE LIABLE FOR ANY SPECIAL, INDIRECT, INCIDENTAL, OR CONSEQUENTIAL DAMAGES, INCLUDING WITHOUT LIMITATION, LOST REVENUES OR LOST PROFITS, WHICH MAY RESULT FROM THE USE OF THESE MATERIALS.

MACOM products are not intended for use in medical, lifesaving or life sustaining applications. MACOM customers using or selling MACOM products for use in such applications do so at their own risk and agree to fully indemnify MACOM for any damages resulting from such improper use or sale.