



Is Now Part of



ON Semiconductor®

To learn more about ON Semiconductor, please visit our website at
www.onsemi.com

Please note: As part of the Fairchild Semiconductor integration, some of the Fairchild orderable part numbers will need to change in order to meet ON Semiconductor's system requirements. Since the ON Semiconductor product management systems do not have the ability to manage part nomenclature that utilizes an underscore (_), the underscore (_) in the Fairchild part numbers will be changed to a dash (-). This document may contain device numbers with an underscore (_). Please check the ON Semiconductor website to verify the updated device numbers. The most current and up-to-date ordering information can be found at www.onsemi.com. Please email any questions regarding the system integration to Fairchild_questions@onsemi.com.

ON Semiconductor and the ON Semiconductor logo are trademarks of Semiconductor Components Industries, LLC dba ON Semiconductor or its subsidiaries in the United States and/or other countries. ON Semiconductor owns the rights to a number of patents, trademarks, copyrights, trade secrets, and other intellectual property. A listing of ON Semiconductor's product/patent coverage may be accessed at www.onsemi.com/site/pdf/Patent-Marking.pdf. ON Semiconductor reserves the right to make changes without further notice to any products herein. ON Semiconductor makes no warranty, representation or guarantee regarding the suitability of its products for any particular purpose, nor does ON Semiconductor assume any liability arising out of the application or use of any product or circuit, and specifically disclaims any and all liability, including without limitation special, consequential or incidental damages. Buyer is responsible for its products and applications using ON Semiconductor products, including compliance with all laws, regulations and safety requirements or standards, regardless of any support or applications information provided by ON Semiconductor. "Typical" parameters which may be provided in ON Semiconductor data sheets and/or specifications can and do vary in different applications and actual performance may vary over time. All operating parameters, including "Typicals" must be validated for each customer application by customer's technical experts. ON Semiconductor does not convey any license under its patent rights nor the rights of others. ON Semiconductor products are not designed, intended, or authorized for use as a critical component in life support systems or any FDA Class 3 medical devices or medical devices with a same or similar classification in a foreign jurisdiction or any devices intended for implantation in the human body. Should Buyer purchase or use ON Semiconductor products for any such unintended or unauthorized application, Buyer shall indemnify and hold ON Semiconductor and its officers, employees, subsidiaries, affiliates, and distributors harmless against all claims, costs, damages, and expenses, and reasonable attorney fees arising out of, directly or indirectly, any claim of personal injury or death associated with such unintended or unauthorized use, even if such claim alleges that ON Semiconductor was negligent regarding the design or manufacture of the part. ON Semiconductor is an Equal Opportunity/Affirmative Action Employer. This literature is subject to all applicable copyright laws and is not for resale in any manner.

FOD0721, FOD0720, FOD0710

High CMR, 25Mbit/sec Logic Gate Optocoupler

Features

- 20kV/μs minimum CMR
- 40ns max. propagation delay
- Data Rate, Non-Return Zero Coding
 - 25Mbit/sec (FOD0721 and FOD0720)
 - 12.5Mbit/sec (FOD0710)
- Pulse Width Distortion
 - 6ns (FOD0721)
 - 8ns (FOD0720 and FOD0710)
- +5V CMOS compatibility
- Extended industrial temperature range
 - -40 to 100°C temperature range
- Safety and regulatory approvals
 - UL1577, 3750 VACrms for 1 min. (File #E90700, Volume 2)
 - IEC60747-5-2 pending approval

Description

The FOD0721/0720/0710 family utilizes Fairchild's proprietary coplanar packaging technology, Optoplanar®, and optimized IC design to guarantee minimum 20kV/μs Common Mode Noise Rejection (CMR) rating.

These high-speed logic gate optocouplers consist of a high-speed AlGaAs LED driven by a CMOS IC coupled to a CMOS detector IC, comprising an integrated photodiode, a high-speed transimpedance amplifier and a voltage comparator with an output driver. The CMOS technology coupled to the high efficiency of the LED achieves low power consumption as well as very high speed (40ns propagation delay, 6ns pulse width distortion).

These devices are available in a compact 8-pin small outline package.

Applications

- Industrial fieldbus communications
 - Profibus, DeviceNet, CAN, RS485
- Programmable logic control
- Isolated data acquisition system

Functional Schematic

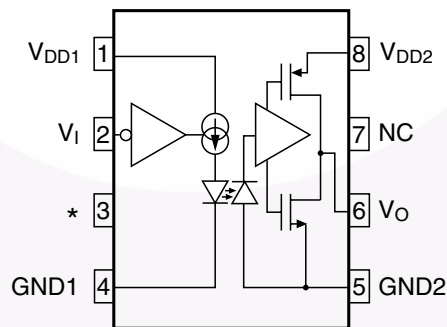

*: Pin 3 must be left unconnected

Truth Table

| V _I | LED | V _O |
|----------------|-----|----------------|
| H | OFF | H |
| L | ON | L |

Pin Definitions

| Pin Number | Pin Name | Pin Function Description |
|------------|------------------|--------------------------------------|
| 1 | V _{DD1} | Input Supply Voltage |
| 2 | V _I | Input Data |
| 3 | | LED Anode – must be left unconnected |
| 4 | GND1 | Input Ground |
| 5 | GND2 | Output Ground |
| 6 | V _O | Output Data |
| 7 | NC | Not Connected |
| 8 | V _{DD2} | Output Supply Voltage |

Absolute Maximum Ratings (T_A = 25°C unless otherwise specified.)

Stresses exceeding the absolute maximum ratings may damage the device. The device may not function or be operable above the recommended operating conditions and stressing the parts to these levels is not recommended. In addition, extended exposure to stresses above the recommended operating conditions may affect device reliability. The absolute maximum ratings are stress ratings only.

| Symbol | Parameter | Value | Units |
|------------------|---|--------------------------------|-------|
| T _{STG} | Storage Temperature | -40 to +125 | °C |
| T _{OPR} | Operating Temperature | -40 to +100 | °C |
| T _{SOL} | Lead Solder Temperature | 260 for 10 sec | °C |
| | Reflow Temperature Profile (Refer to Relow Profile) | | |
| V _{DD1} | Input Supply Voltage | 0 to 6.0 | V |
| V _I | Input Voltage | -0.5 to V _{DD1} + 0.5 | V |
| I _I | Input DC Current | -10 to +10 | mA |
| V _{DD2} | Output Supply Voltage | 0 to 6.0 | V |
| V _D | Output Voltage | -0.5 to V _{DD2} + 0.5 | V |
| I _O | Average Output Current | 10 | mA |
| PD1 | Input Power Dissipation | 90 | mW |
| PD2 | Output Power Dissipation | 70 | mW |

Recommended Operating Conditions

The Recommended Operating Conditions table defines the conditions for actual device operation. Recommended operating conditions are specified to ensure optimal performance to the datasheet specifications. Fairchild does not recommend exceeding them or designing to absolute maximum ratings.

| Symbol | Parameter | Min. | Max. | Unit |
|-------------------------------------|---------------------------------|------|------------------|------|
| T _{OPR} | Ambient Operating Temperature | -40 | +100 | °C |
| V _{DD1} , V _{DD2} | Supply Voltages | 4.5 | 5.5 | V |
| V _{IH} | Logic High Input Voltage | 2.0 | V _{DD1} | V |
| V _{IL} | Logic Low Input Voltage | 0 | 0.8 | V |
| t _r , t _f | Input Signal Rise and Fall Time | | 1.0 | ms |

- A 0.1μF bypass capacitor must be connected between pins 1 and 4, and 5 and 8
- Pin 3 must be left unconnected

Electrical Characteristics ($T_A = -40^{\circ}\text{C}$ to 100°C and $4.5\text{V} \leq V_{DD} \leq 5.5\text{V}$, all typicals are at $T_A = 25^{\circ}\text{C}$, $V_{DD} = 5\text{V}$)

| Symbol | Parameter | Test Conditions | Min. | Typ. | Max. | Unit |
|-------------------------------|----------------------------------|---|------|------|------|---------------|
| INPUT CHARACTERISTICS | | | | | | |
| I_{DD1L} | Logic Low Input Supply Current | $V_I = 0\text{V}$ | | 6.5 | 10.0 | mA |
| I_{DD1H} | Logic High Input Supply Current | $V_I = V_{DD1}$ | | 0.8 | 3.0 | mA |
| I_{DD1} | Input Supply Current | | | | 13.0 | mA |
| I_I | Input Current | | -10 | | +10 | μA |
| OUTPUT CHARACTERISTICS | | | | | | |
| I_{DD2L} | Logic Low Output Supply Current | $V_I = 0\text{V}$ | | 5.5 | 9 | mA |
| I_{DD2H} | Logic High Output Supply Current | $V_I = V_{DD1}$ | | 5.3 | 9 | mA |
| V_{OH} | Logic High Output Voltage | $I_O = -20\mu\text{A}$, $V_I = V_{IH}$ | 4.4 | 5.0 | | V |
| V_{OH} | | $I_O = -4\text{mA}$, $V_I = V_{IH}$ | 4.0 | 4.8 | | V |
| V_{OL} | Logic Low Output Voltage | $I_O = 20\mu\text{A}$, $V_I = V_{IL}$ | | 0 | 0.1 | V |
| V_{OL} | | $I_O = 4\text{mA}$, $V_I = V_{IL}$ | | 0.5 | 1.0 | V |

Isolation Characteristics ($T_A = -40^{\circ}\text{C}$ to $+100^{\circ}\text{C}$ unless otherwise specified.)

| Symbol | Characteristics | Test Conditions | Min. | Typ.* | Max. | Unit |
|-----------|--------------------------------|--|-----------|-------|------|-------------|
| V_{ISO} | Input-Output Isolation Voltage | $f = 60\text{Hz}$, $t = 1.0\text{ min}$, $I_{I-O} \leq 10\mu\text{A}^{(1)(2)}$ | 3750 | | | V_{aCRMS} |
| R_{ISO} | Isolation Resistance | $V_{I-O} = 500\text{V}^{(1)}$ | 10^{11} | | | Ω |
| C_{ISO} | Isolation Capacitance | $V_{I-O} = 0$, $f = 1.0\text{MHz}^{(1)}$ | | 0.2 | | pF |

*All typicals at $T_A = 25^{\circ}\text{C}$ **Notes:**

- Device is considered a two terminal device: Pins 1, 2, 3 and 4 are shorted together and Pins 5, 6, 7 and 8 are shorted together.
- 3,750 VAC RMS for 1 minute duration is equivalent to 4,500 VAC RMS for 1 second duration.

Switching Characteristics ($T_A = -40^\circ\text{C}$ to 100°C and $4.5\text{V} \leq V_{DD} \leq 5.5\text{V}$, all typicals are at $T_A = 25^\circ\text{C}$, $V_{DD} = 5\text{V}$)

| Symbol | Parameter | Test Conditions | Min. | Typ. | Max. | Unit |
|-----------|---|--|------|------|------|-------------------|
| t_{PHL} | Propagation Delay Time to Logic Low Output | $C_L = 15\text{pF}$ | | 21 | 40 | ns |
| t_{PLH} | Propagation Delay Time to Logic High Output | $C_L = 15\text{pF}$ | | 23 | 40 | ns |
| PWD | Pulse Width Distortion, $ t_{PHL} - t_{PLH} $ | | | | | |
| | FOD0710 | $PW = 80\text{ns}$, $C_L = 15\text{pF}$ | | 2 | 8 | ns |
| | FOD0720 | $PW = 40\text{ns}$, $C_L = 15\text{pF}$ | | 2 | 8 | ns |
| | FOD0721 | $PW = 40\text{ns}$, $C_L = 15\text{pF}$ | | 2 | 6 | ns |
| Data Rate | FOD0710 | | | | 12.5 | Mb/s |
| | FOD0720, FOD0721 | | | | 25 | Mb/s |
| t_{PSK} | Propagation Delay Skew | $C_L = 15\text{pF}^{(3)}$ | | | 20 | ns |
| t_R | Output Rise Time (10%–90%) | | | 5 | | ns |
| t_F | Output Fall Time (90%–10%) | | | 4.5 | | ns |
| $ CM_H $ | Common Mode Transient Immunity at Output High | $V_I = V_{DD1}$, $V_O > 0.8 V_{DD2}$ $V_{CM} = 1000\text{V}^{(4)}$ | 20 | 40 | | kV/ μs |
| $ CM_L $ | Common Mode Transient Immunity at Output Low | $V_I = 0\text{V}$, $V_O < 0.8$, $V_{CM} = 1000\text{V}^{(4)}$ | 20 | 40 | | kV/ μs |

Notes:

- t_{PSK} is equal to the magnitude of the worst case difference in t_{PHL} and/or t_{PLH} that will be seen between units at any given temperature within the recommended operating conditions.
- Common mode transient immunity at output high is the maximum tolerable (positive) dV_{cm}/dt on the leading edge of the common mode impulse signal. V_{cm} , to assure that the output will remain high. Common mode transient immunity at output low is the maximum tolerable (negative dV_{cm}/dt on the trailing edge of the common pulse signal, V_{cm} , to assure that the output will remain low.

Typical Performance Curves

Figure 1. Typical Output Voltage vs. Input Voltage

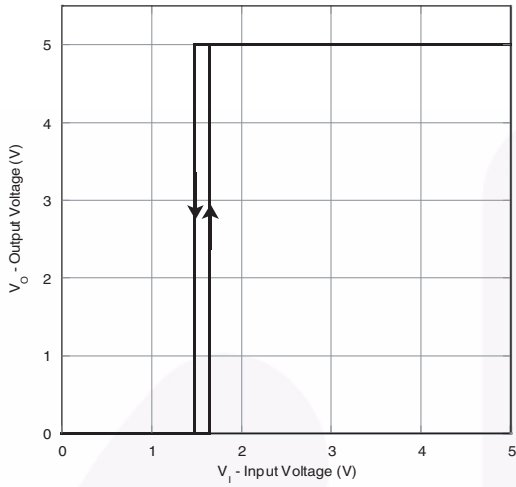

Figure 2. Typical Input Voltage Switching Threshold vs. Input Supply Voltage

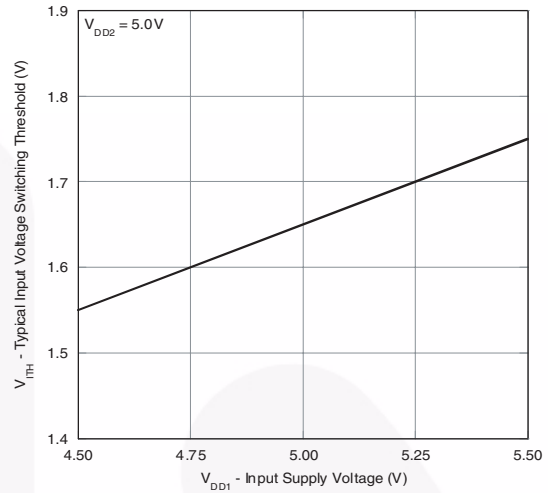

Figure 3. Typical Propagation Delay vs. Ambient Temperature (FOD0710)

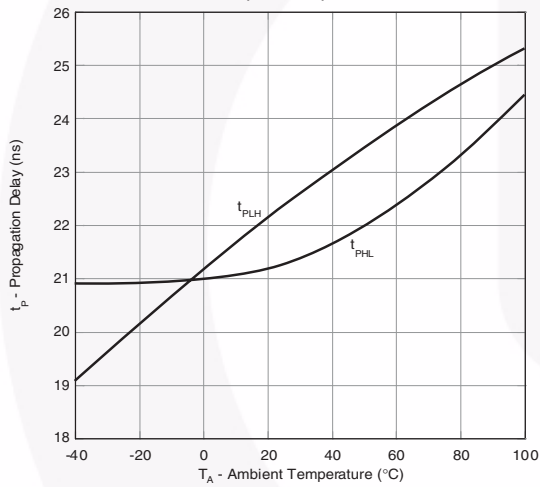

Figure 4. Typical Pulse Width Distortion vs. Ambient Temperature (FOD0710)

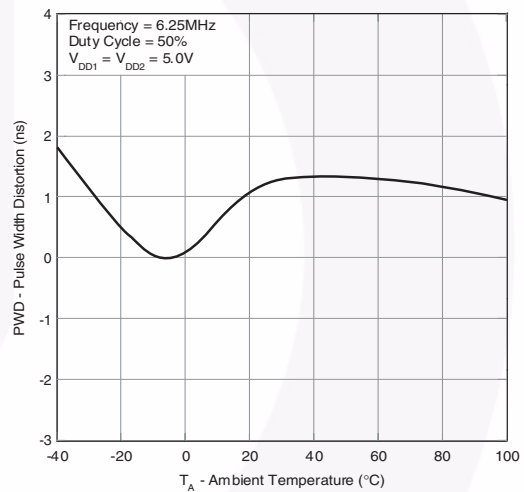

Figure 5. Typical Propagation Delay vs. Ambient Temperature (FOD0721/FOD0720)

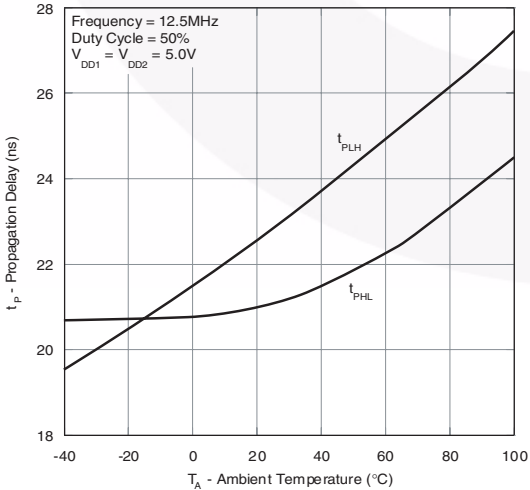
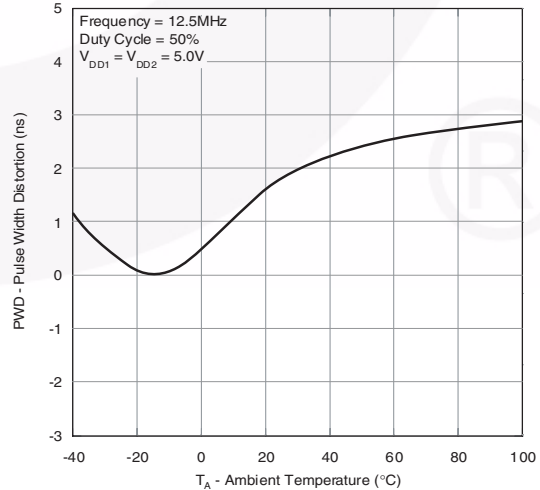

Figure 6. Typical Pulse Width Distortion vs. Ambient Temperature (FOD0721/FOD0720)



Typical Performance Curves (Continued)

Figure 7. Typical Rise and Fall Time vs. Ambient Temperature

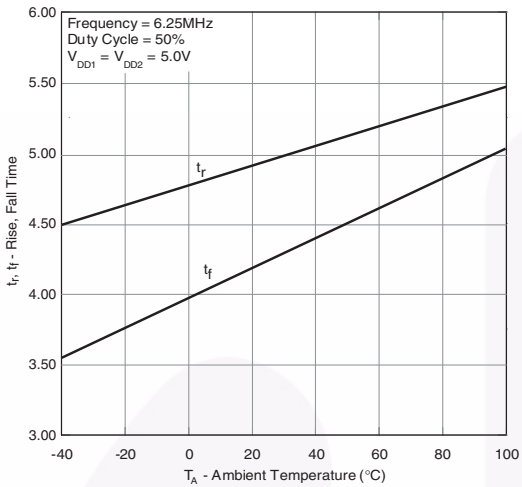

Figure 8. Typical Propagation Delay vs. Output Load Capacitance (FOD0710)

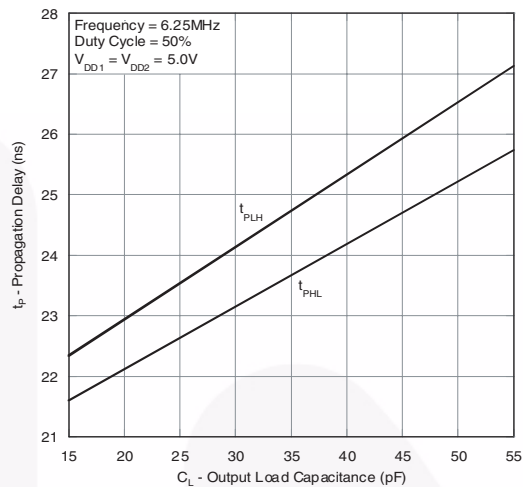

Figure 9. Typical Pulse Width Distortion vs. Output Load Capacitance (FOD0710)

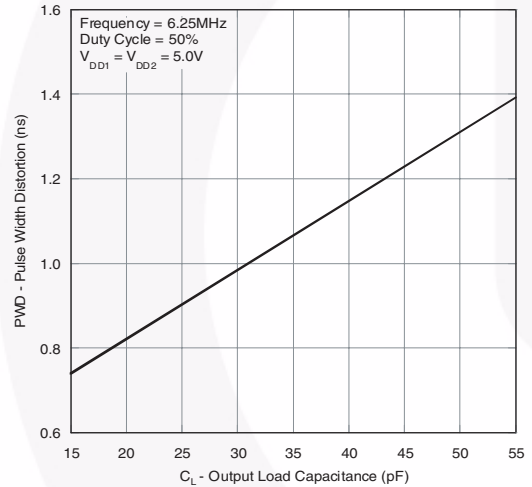

Figure 10. Typical Propagation Delay vs. Output Load Capacitance (FOD0721/FOD0720)

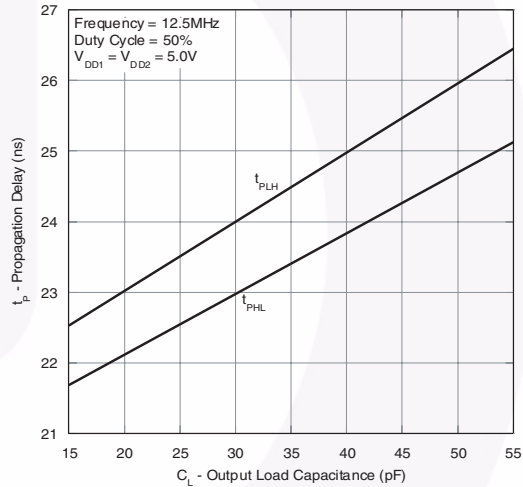

Figure 11. Typical Pulse Width Distortion vs. Output Load Capacitance (FOD0721/FOD0720)

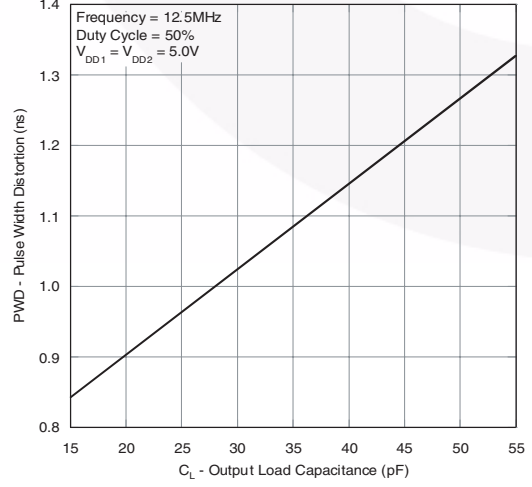
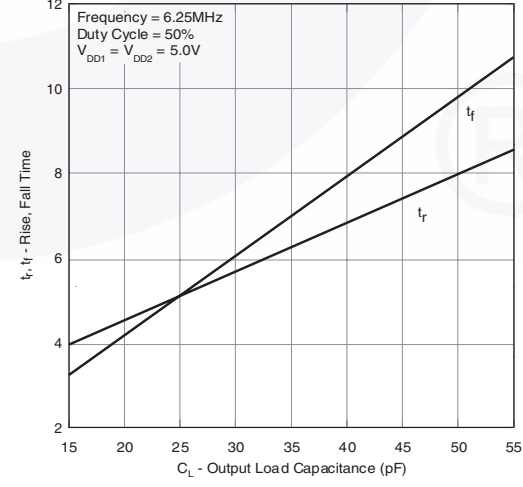

Figure 12. Typical Rise and Fall Time vs. Output Load Capacitance (FOD0710)



Typical Performance Curves (Continued)

Figure 13. Typical Rise and Fall Time vs. Output Load Capacitance (FOD0721/FOD0720)

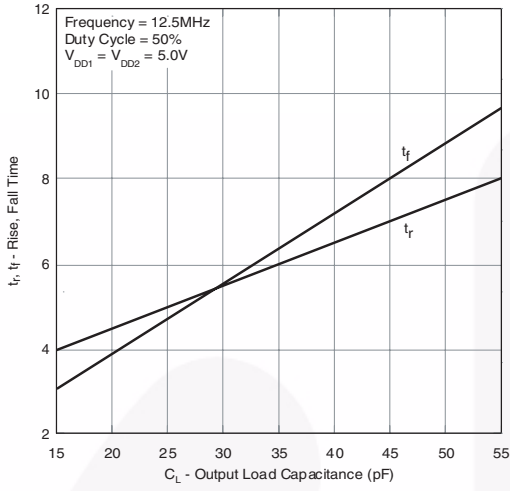

Figure 14. Typical Input Supply Current vs. Frequency

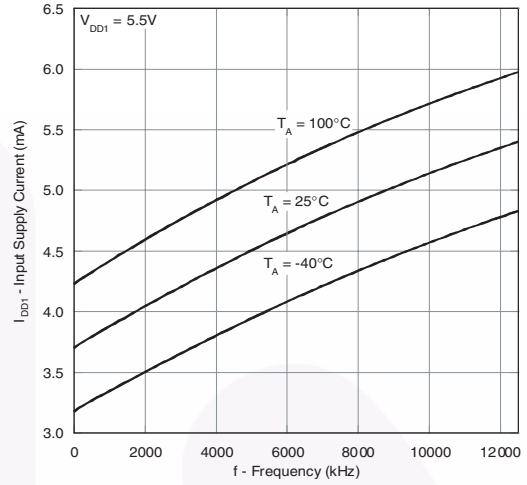
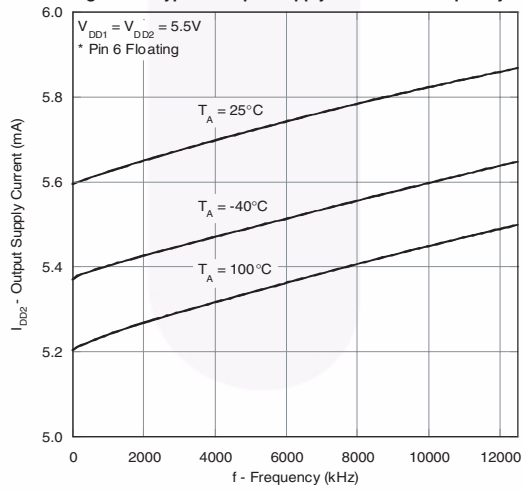



Figure 15. Typical Output Supply Current vs. Frequency



Ordering Information

| Option | Order Entry Identifier | Description |
|-----------|------------------------|--------------------------------------|
| No Suffix | FOD0721 | Shipped in Tubes (50 units per tube) |
| R2 | FOD0721R2 | Tape and Reel (2500 units per reel) |

 All packages are lead free per JEDEC: J-STD-020B standard.

Marking Information

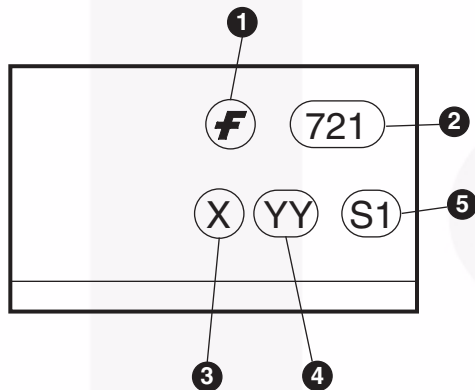

| Definitions | |
|-------------|---|
| 1 | Fairchild logo |
| 2 | Device number |
| 3 | One digit year code, e.g., '8' |
| 4 | Two digit work week ranging from '01' to '53' |
| 5 | Assembly package code |

Carrier Tape Specification

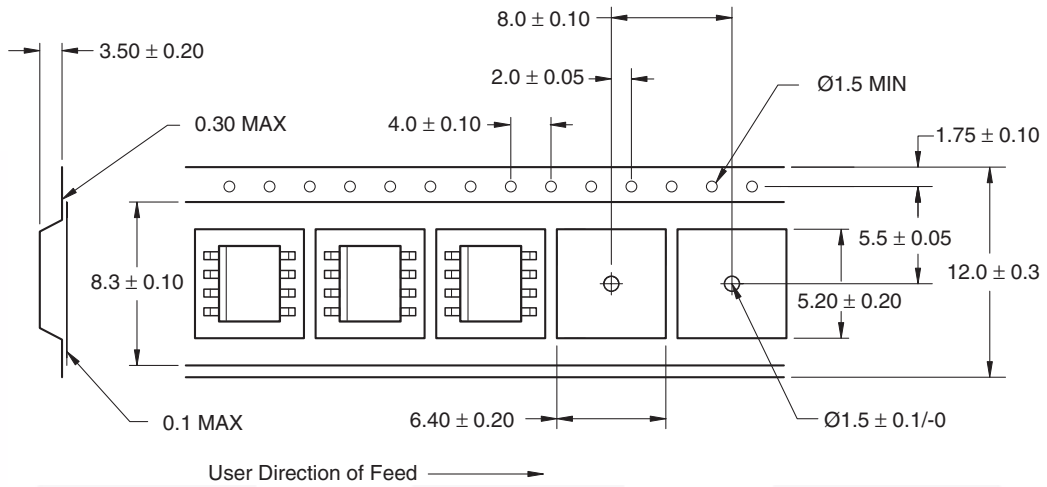

Note:
All dimensions are in millimeters.

Reflow Profile

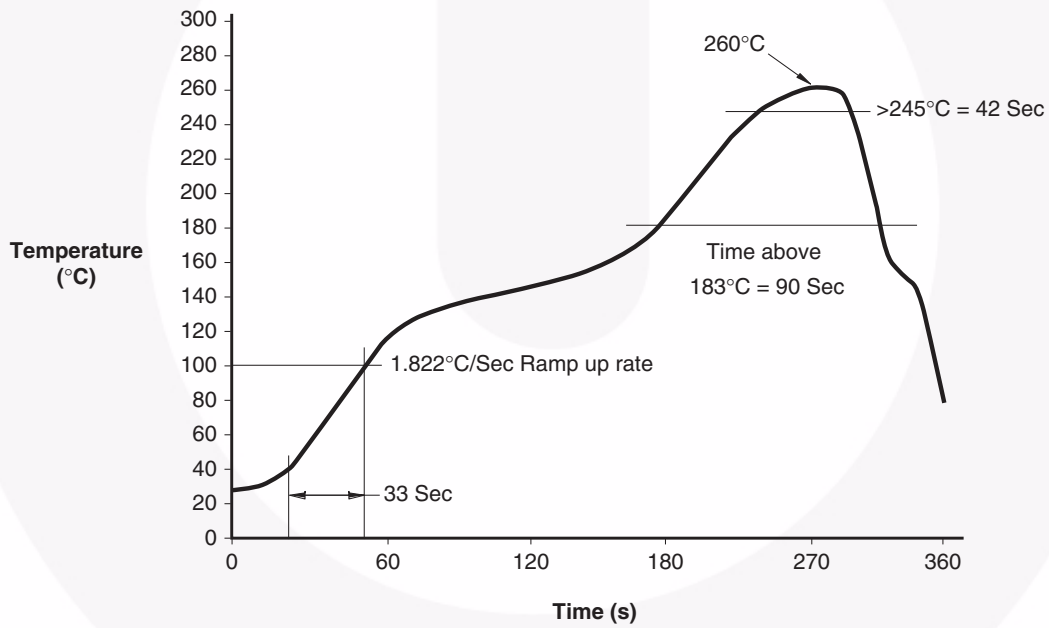

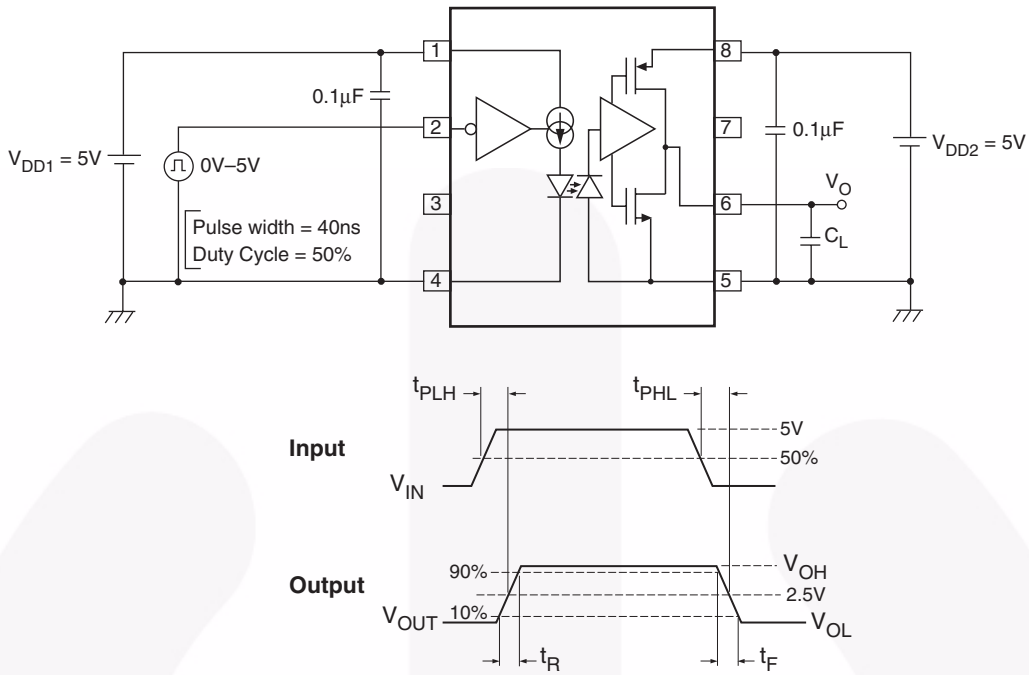

Figure 16. Test Circuit for Propagation Delay Time and Rise Time, Fall Time

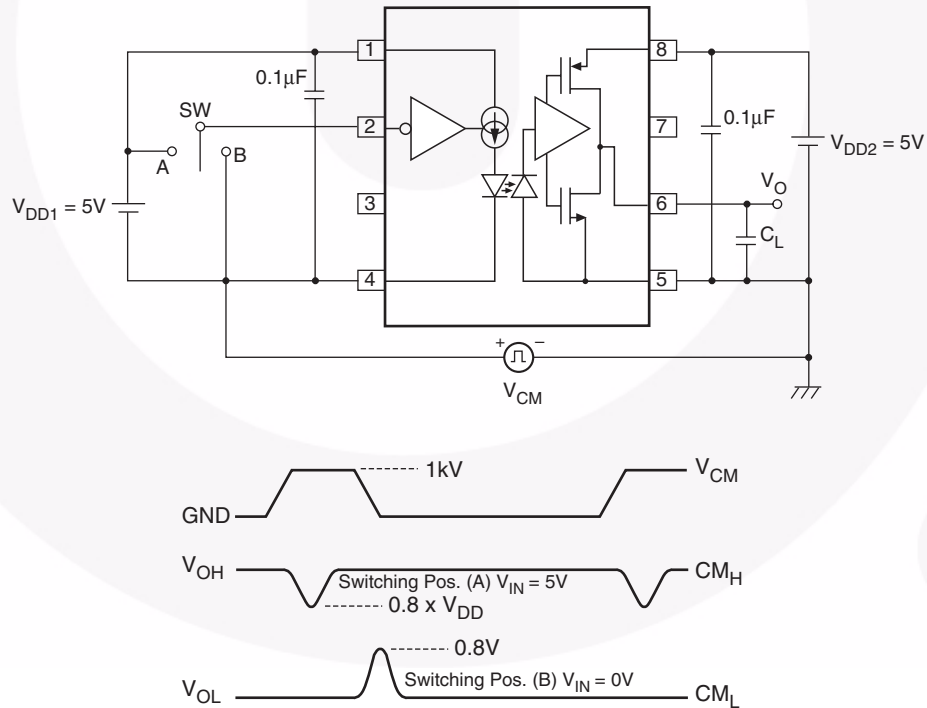

Figure 17. Test Circuit for Instantaneous Common Mode Rejection Voltage



NOTES:

- A) NO STANDARD APPLIES TO THIS PACKAGE
- B) ALL DIMENSIONS ARE IN MILLIMETERS.
- C) DIMENSIONS DO NOT INCLUDE MOLD FLASH OR BURRS.
- D) LANDPATTERN STANDARD: SOIC127P600X175-8M.
- E) DRAWING FILENAME: MKT-M08Erev5



ON Semiconductor and  are trademarks of Semiconductor Components Industries, LLC dba ON Semiconductor or its subsidiaries in the United States and/or other countries. ON Semiconductor owns the rights to a number of patents, trademarks, copyrights, trade secrets, and other intellectual property. A listing of ON Semiconductor's product/patent coverage may be accessed at www.onsemi.com/site/pdf/Patent-Marking.pdf. ON Semiconductor reserves the right to make changes without further notice to any products herein. ON Semiconductor makes no warranty, representation or guarantee regarding the suitability of its products for any particular purpose, nor does ON Semiconductor assume any liability arising out of the application or use of any product or circuit, and specifically disclaims any and all liability, including without limitation special, consequential or incidental damages. Buyer is responsible for its products and applications using ON Semiconductor products, including compliance with all laws, regulations and safety requirements or standards, regardless of any support or applications information provided by ON Semiconductor. "Typical" parameters which may be provided in ON Semiconductor data sheets and/or specifications can and do vary in different applications and actual performance may vary over time. All operating parameters, including "Typicals" must be validated for each customer application by customer's technical experts. ON Semiconductor does not convey any license under its patent rights nor the rights of others. ON Semiconductor products are not designed, intended, or authorized for use as a critical component in life support systems or any FDA Class 3 medical devices or medical devices with a same or similar classification in a foreign jurisdiction or any devices intended for implantation in the human body. Should Buyer purchase or use ON Semiconductor products for any such unintended or unauthorized application, Buyer shall indemnify and hold ON Semiconductor and its officers, employees, subsidiaries, affiliates, and distributors harmless against all claims, costs, damages, and expenses, and reasonable attorney fees arising out of, directly or indirectly, any claim of personal injury or death associated with such unintended or unauthorized use, even if such claim alleges that ON Semiconductor was negligent regarding the design or manufacture of the part. ON Semiconductor is an Equal Opportunity/Affirmative Action Employer. This literature is subject to all applicable copyright laws and is not for resale in any manner.

PUBLICATION ORDERING INFORMATION

LITERATURE FULFILLMENT:

Literature Distribution Center for ON Semiconductor
19521 E. 32nd Pkwy, Aurora, Colorado 80011 USA
Phone: 303-675-2175 or 800-344-3860 Toll Free USA/Canada
Fax: 303-675-2176 or 800-344-3867 Toll Free USA/Canada
Email: orderlit@onsemi.com

N. American Technical Support: 800-282-9855 Toll Free
USA/Canada
Europe, Middle East and Africa Technical Support:
Phone: 421 33 790 2910
Japan Customer Focus Center
Phone: 81-3-5817-1050

ON Semiconductor Website: www.onsemi.com
Order Literature: <http://www.onsemi.com/orderlit>
For additional information, please contact your local
Sales Representative

Mouser Electronics

Authorized Distributor

Click to View Pricing, Inventory, Delivery & Lifecycle Information:

[ON Semiconductor:](#)

[FOD0720R2](#) [FOD0720](#)