

THIS DRAWING IS UNPUBLISHED. RELEASED FOR PUBLICATION
 © COPYRIGHT - By - ALL RIGHTS RESERVED.

REVISIONS

P	LTR	DESCRIPTION	DATE	DWN	APVD
A		INITIAL RELEASE	30NOV2013	YC	BvH
A1		ECR-14-015049	13OCT2014	GSK	BvH
A2		ECR-16-003945	16MAR2016	GSK	BvH

NOTES:
 Tolerances cable lengths:
 0m to 0.5m +30mm
 0.5m to 1.0m +50mm
 1.0m to 3.0m +100mm
 < 3.0m +1.5%

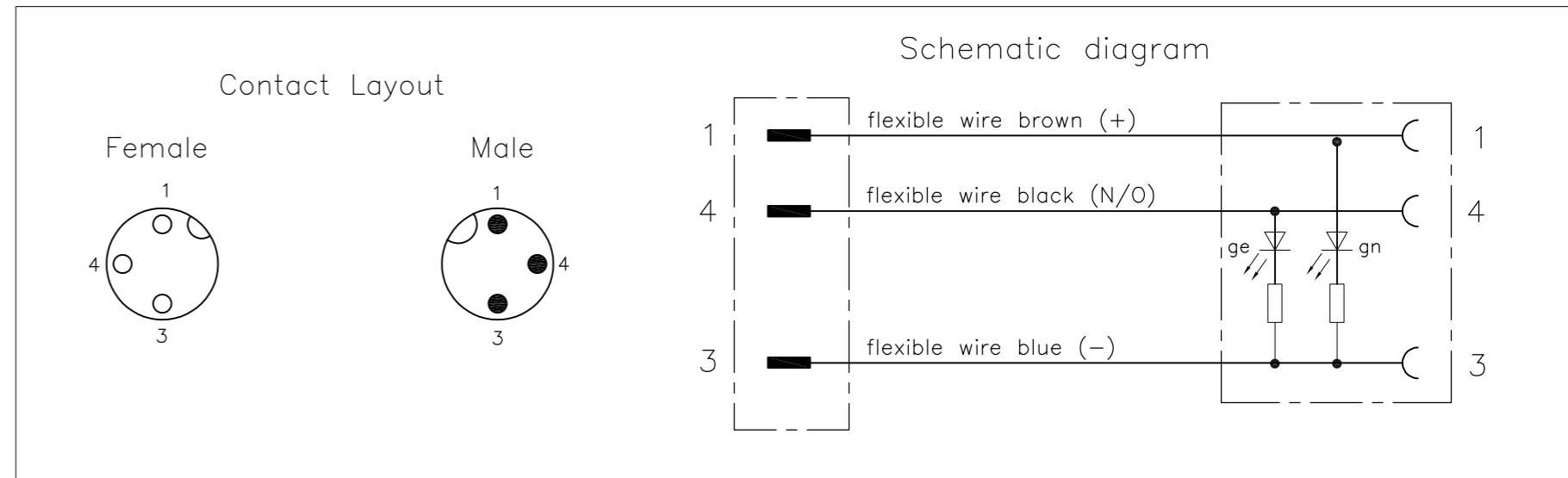
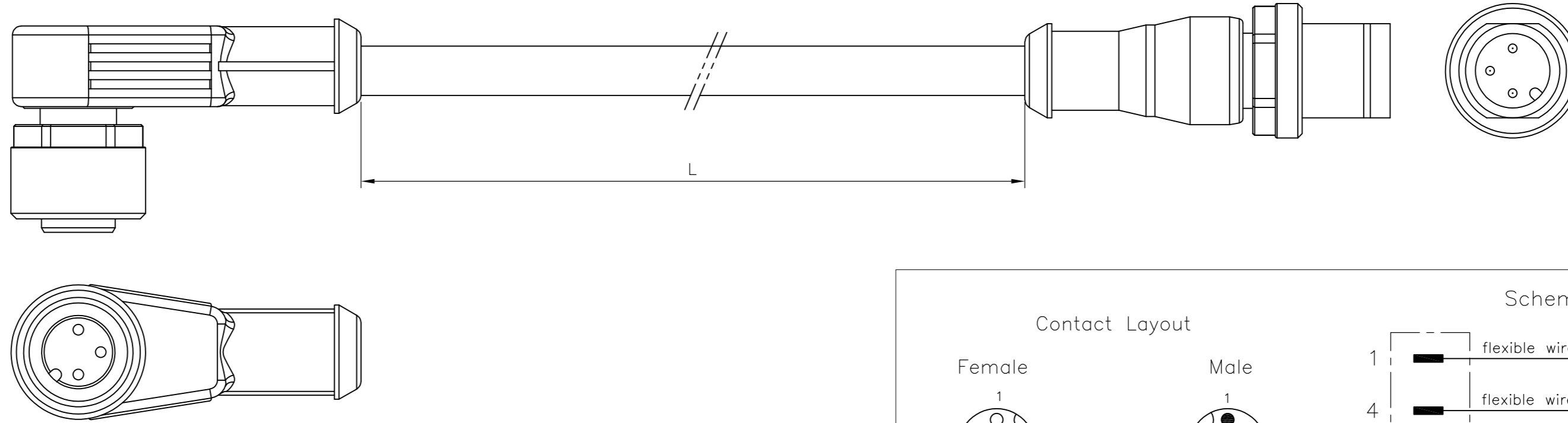

TECHNICAL DATA	
Operating voltage	24 V DC ±25 %
Operating current per contact	max. 4 A
Locking of ports	Screw thread M12 x 1 mm (recommended torque 0.6 Nm) self-securing
Protection	IP65 and IP67 when plugged and screwed down (EN 60529)

PUR/PVC CABLE	
No./diameter of wires	3 x 0.34 mm ²
Wire isolation	PVC (br, bl, bk)
C-track properties	2 million
Jacket	PUR/PVC
Outer diameter	approx. 4.9 mm
Bend radius (moving)	15 x outer diameter
Temperature range (fixed)	-30...+80 °C
Temperature range (mobile)	-5...+80 °C

CABLE	
No./diameter of wires	3 x 0.34 mm ²
Wire isolation	PP (br, bl, bk)
C-track properties	10 million
Jacket	PUR (UL/CSA), welding spark res.
Outer diameter	approx. 4.3 mm
Bend radius (moving)	10 x outer diameter
Temperature range (fixed)	-40...+90 °C
Temperature range (mobile)	-25...+90 °C

LENGTH "L"	MATERIAL	JACKET COLOR	TE PN	DESCRIPTION	ITEM
3 pos	SPARK RESISTANT	Black	3-2273125-5	3x22AWG SPARK RES 2.0m	20
			3-2273125-4	3x22AWG SPARK RES 1.5m	19
			3-2273125-3	3x22AWG SPARK RES 1.0m	18
			3-2273125-2	3x22AWG SPARK RES 0.6m	17
			3-2273125-1	3x22AWG SPARK RES 0.3m	16
3 pos	PUR/PVC	Black	2-2273125-5	3x22AWG PUR/PVC 2.0m	15
			2-2273125-4	3x22AWG PUR/PVC 1.5m	14
			2-2273125-3	3x22AWG PUR/PVC 1.0m	13
			2-2273125-2	3x22AWG PUR/PVC 0.6m	12
			2-2273125-1	3x22AWG PUR/PVC 0.3m	11

TECHNICAL DATA	
Operating voltage	24 V DC ±25 %
Operating current per contact	max. 4 A
Locking of ports	Screw thread M12 x 1 mm (recommended torque 0.6 Nm) self-securing
Protection	IP65 and IP67 when plugged and screwed down (EN 60529)

PUR CABLE	
No./diameter of wires	3 x 0.34 mm ²
Wire isolation	PP (br, bl, bk)
C-track properties	5 million
Jacket	PUR (UL/CSA)
Outer diameter	approx. 4.3 mm
Bend radius (moving)	10 x outer diameter
Temperature range (fixed)	-40...+80 °C
Temperature range (mobile)	-25...+80 °C

PVC CABLE	
No./diameter of wires	3 x 0.34 mm ²
Wire isolation	PVC (br, bl, bk)
C-track properties	
Jacket	PVC (UL/CSA)
Outer diameter	approx. 4.6 mm
Bend radius (moving)	10 x outer diameter
Temperature range (fixed)	-30...+80 °C
Temperature range (mobile)	-5...+80 °C

LENGTH "L"	MATERIAL	JACKET COLOR	TE PN	DESCRIPTION	ITEM
3 pos	PVC	Black	1-2273125-5	3x22AWG PVC 2.0m	10
			1-2273125-4	3x22AWG PVC 1.5m	9
			1-2273125-3	3x22AWG PVC 1.0m	8
			1-2273125-2	3x22AWG PVC 0.6m	7
			1-2273125-1	3x22AWG PVC 0.3m	6
3 pos	PUR	Black	2273125-5	3x22AWG PUR 2.0m	5
			2273125-4	3x22AWG PUR 1.5m	4
			2273125-3	3x22AWG PUR 1.0m	3
			2273125-2	3x22AWG PUR 0.6m	2
			2273125-1	3x22AWG PUR 0.3m	1

THIS DRAWING IS A CONTROLLED DOCUMENT.

DWN	30NOV2013	YATHISH.C
CHK	30NOV2013	B.VELDHOVEN
APVD	30NOV2013	A.VAN ZANDVOORT
PRODUCT SPEC		
108-19483		
APPLICATION SPEC		
114-32127		
WEIGHT		
CUSTOMER DRAWING		

TE Connectivity

M12 ANGLD SCKT TO M12 STRGHT PLG 2 LED

SIZE	CAGE CODE	DRAWING NO	RESTRICTED TO
A2	00779	C=2273125	-
SCALE	SHEET	REV	
NTS	1 OF 1	A2	

Mouser Electronics

Authorized Distributor

Click to View Pricing, Inventory, Delivery & Lifecycle Information:

[TE Connectivity:](#)

[3-2273125-3](#)