

## Automotive low drop power Schottky rectifier

Datasheet - production data

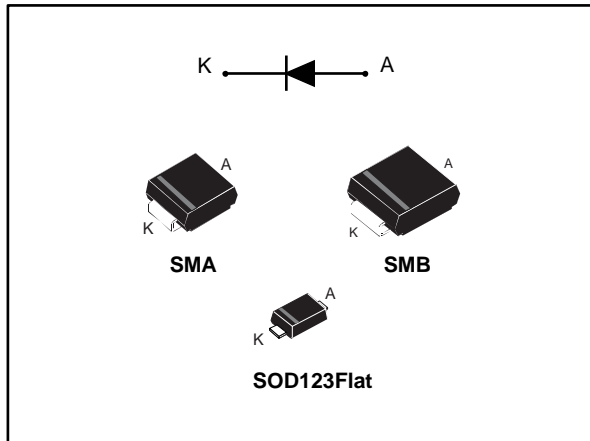

### Description

Single chip Schottky rectifiers suited to switched mode power supplies and high frequency DC to DC converters.

Packaged in SOD123Flat, SMA and SMB, this device is especially intended for surface mounting and used in low voltage, high frequency inverters, free-wheeling and polarity protection in automotive applications.

Table 1: Device summary

Symbol	Value
$I_{F(AV)}$	1 A
$V_{RRM}$	40 V
$V_F$ (typ.)	0.37 V
$T_j$ (max.)	175 °C

### Features

- AEC-Q101 qualified
- Very small conduction losses
- Negligible switching losses
- Low forward voltage drop
- Surface mount miniature packages
- Avalanche capability specified
- PPAP capable



# 1 Characteristics

**Table 2: Absolute ratings (limiting values at 25 °C, unless otherwise specified)**

Symbol	Parameter		Value	Unit
V <sub>RRM</sub>	Repetitive peak reverse voltage	T <sub>j</sub> = -40 °C to +175 °C	40	V
I <sub>F(AV)</sub>	Average forward current δ = 0.5, square wave	SMA/SMB: T <sub>L</sub> = 155 °C	1	A
		SOD123Flat: T <sub>L</sub> = 160 °C		
I <sub>FSM</sub>	Surge non repetitive forward current, t <sub>p</sub> = 10 ms sinusoidal	SMA/SMB	60	A
		SOD123Flat	50	
P <sub>ARM</sub>	Repetitive peak avalanche power	t <sub>p</sub> = 10 μs, T <sub>j</sub> = 125 °C	65	W
T <sub>stg</sub>	Storage temperature range		-65 to +175	°C
T <sub>j</sub>	Operating junction temperature range <sup>(1)</sup>		-40 to +175	

**Notes:**

<sup>(1)</sup>(dP<sub>tot</sub>/dT<sub>j</sub>) < (1/R<sub>th(j-a)</sub>) condition to avoid thermal runaway for a diode on its own heatsink.

**Table 3: Thermal parameters**

Symbol	Parameter	Max. value	Unit
R <sub>th(j-l)</sub>	Junction to lead	SMA	30
		SMB	25
		SOD123Flat	20
			°C/W

**Table 4: Static electrical characteristics**

Symbol	Parameter	Test conditions		Min.	Typ.	Max.	Unit
I <sub>R</sub> <sup>(1)</sup>	Reverse leakage current	T <sub>j</sub> = 25 °C	V <sub>R</sub> = V <sub>RRM</sub>	-		35	μA
		T <sub>j</sub> = 125 °C		-	6	10	mA
V <sub>F</sub> <sup>(2)</sup>	Forward voltage drop	T <sub>j</sub> = 25 °C	I <sub>F</sub> = 1 A	-		0.50	V
		T <sub>j</sub> = 125 °C		-	0.37	0.42	

**Notes:**

<sup>(1)</sup>Pulse test: t<sub>p</sub> = 5 ms, δ < 2%

<sup>(2)</sup>Pulse test: t<sub>p</sub> = 380 μs, δ < 2%

To evaluate the conduction losses, use the following equation:

$$P = 0.23 \times I_{F(AV)} + 0.19 \times I_{F(RMS)}^2$$

For more information, please refer to the following application notes related to the power losses.

- AN604 (Calculation of conduction losses in a power rectifier)
- AN4021 (Calculation of reverse losses in a power diode)

# 1.1 Characteristics (curves)

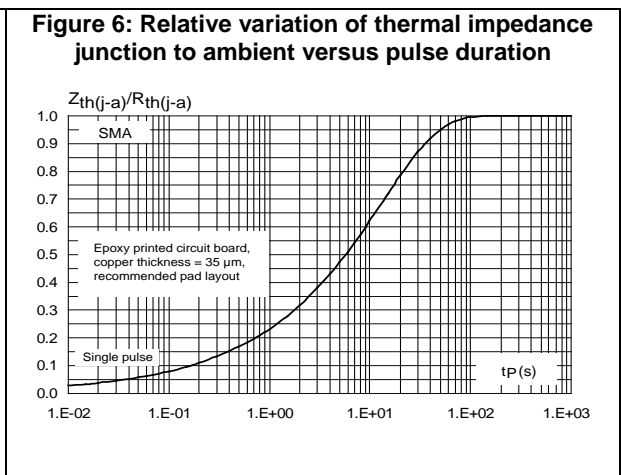
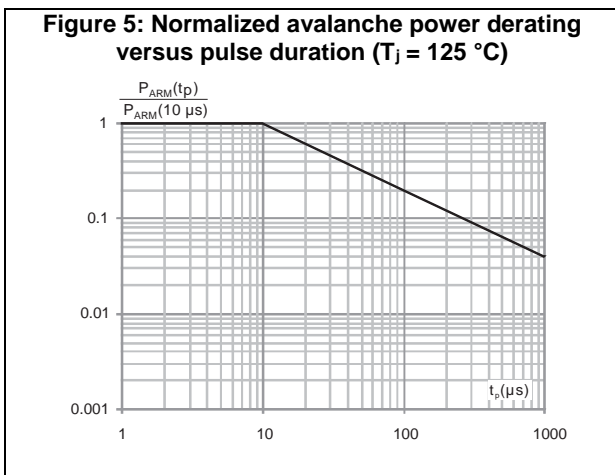
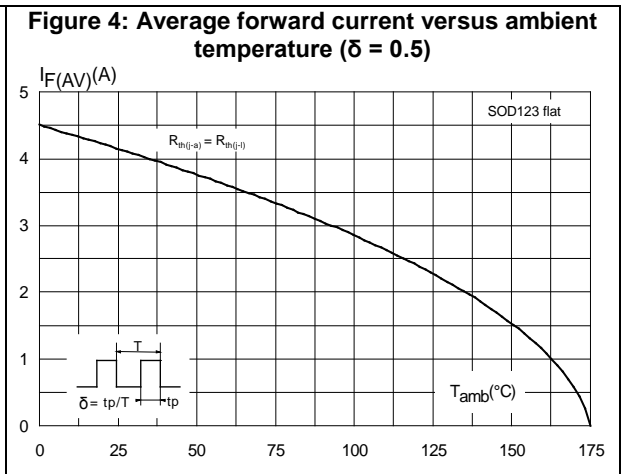
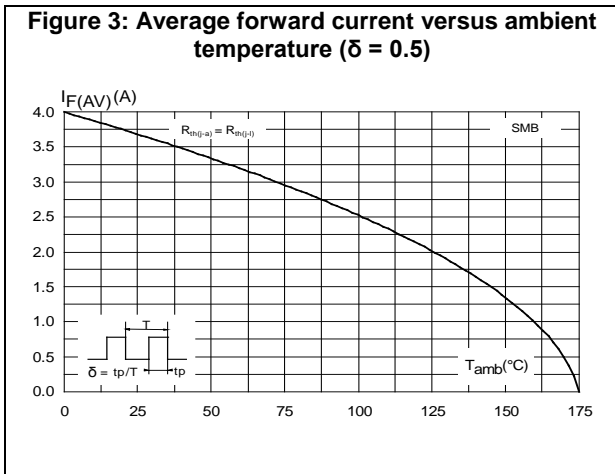
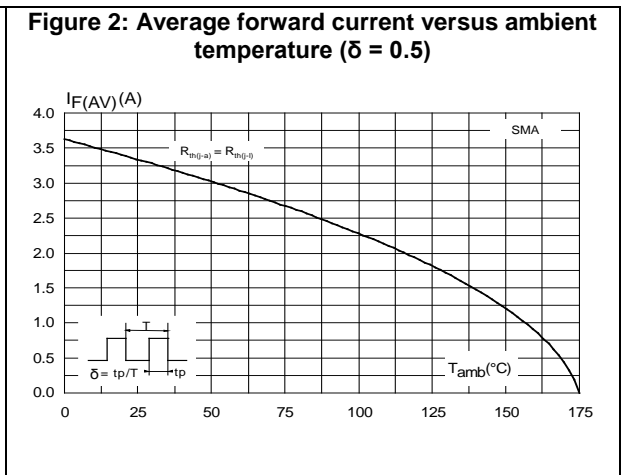
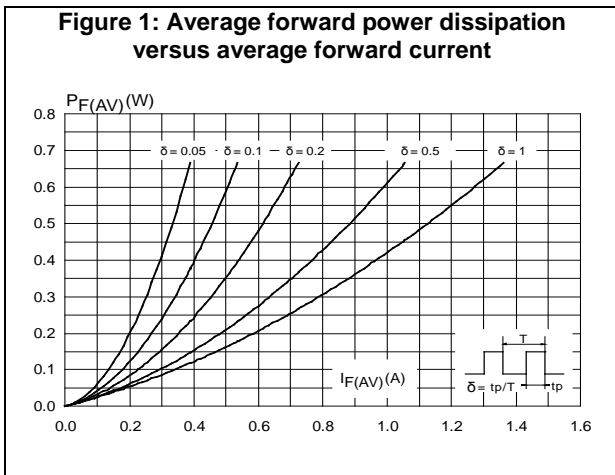

**Figure 7: Relative variation of thermal impedance junction to ambient versus pulse duration**

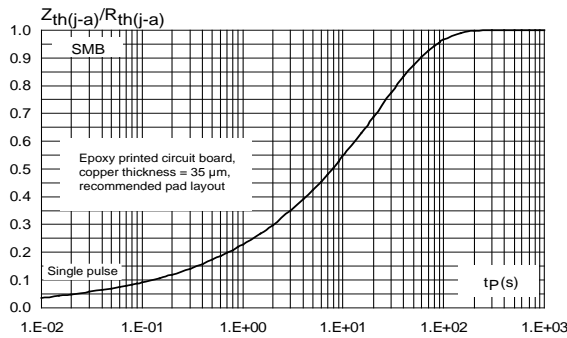

**Figure 8: Relative variation of thermal impedance junction to lead versus pulse duration**

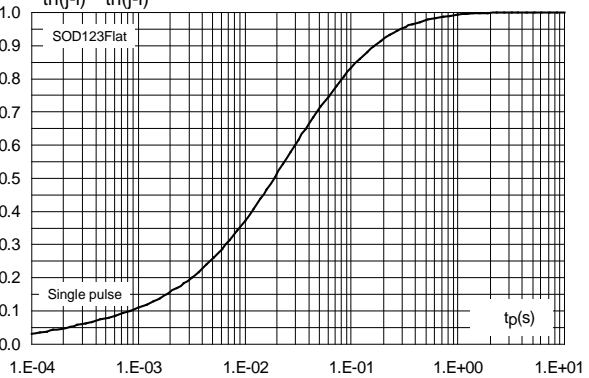

**Figure 9: Reverse leakage current versus reverse voltage applied (typical values)**

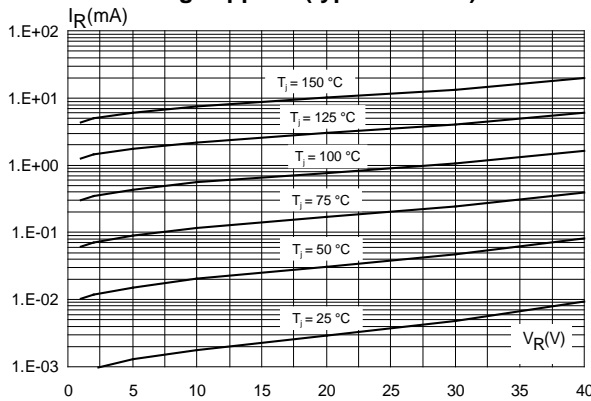

**Figure 10: Junction capacitance versus reverse voltage applied (typical values)**

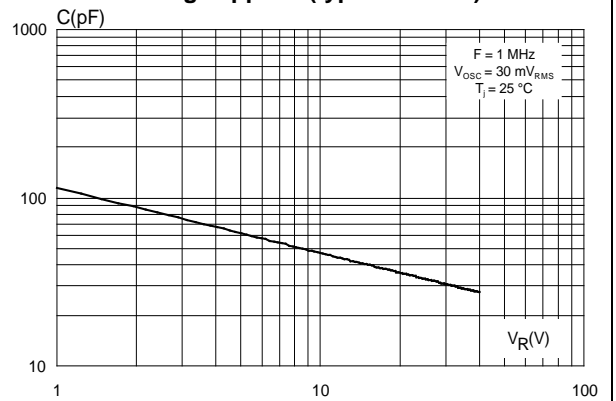

**Figure 11: Forward voltage drop versus forward current (typical values)**

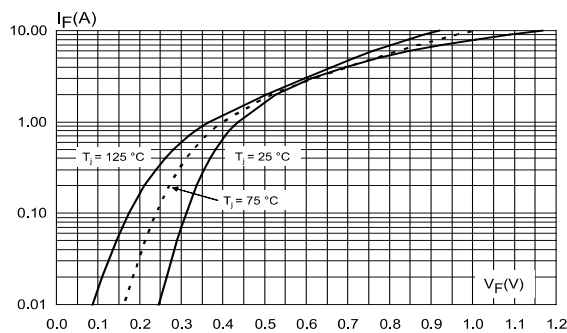

**Figure 12: Thermal resistance junction to ambient versus copper surface under each lead (typical values)**

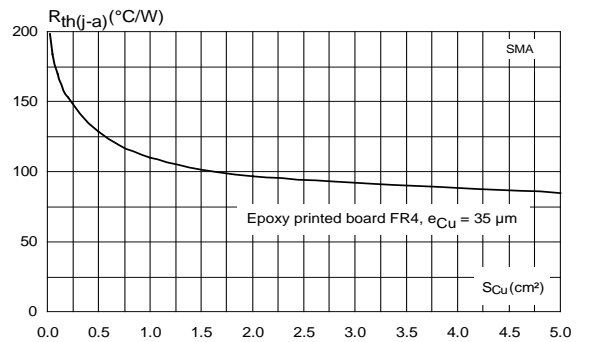

**Figure 13: Thermal resistance junction to ambient versus copper surface under each lead (typical values)**

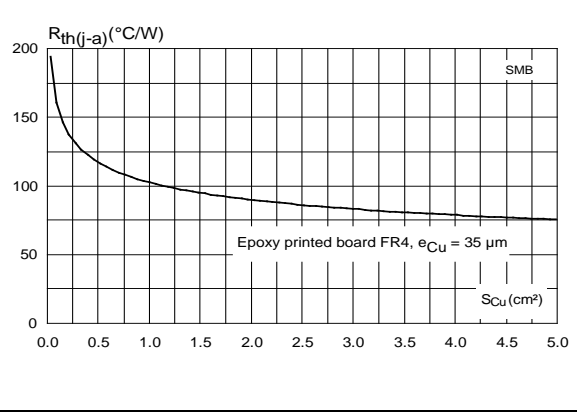

**Figure 14: Thermal resistance junction to ambient versus copper surface under each lead (typical values)**

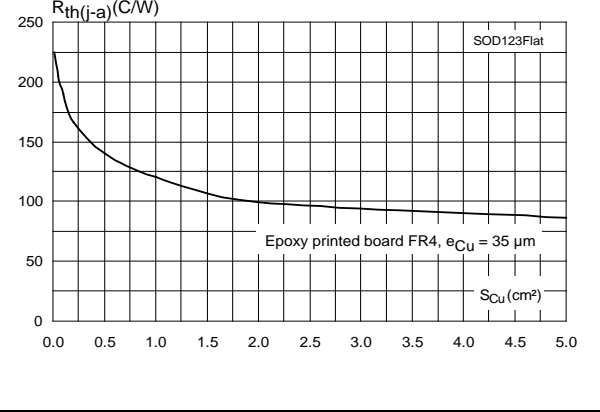

## 2 Package information

In order to meet environmental requirements, ST offers these devices in different grades of ECOPACK® packages, depending on their level of environmental compliance. ECOPACK® specifications, grade definitions and product status are available at: [www.st.com](http://www.st.com). ECOPACK® is an ST trademark.

- Epoxy meets UL94, V0
- Cooling method: by conduction (C)

### 2.1 SMA package information

Figure 15: SMA package outline

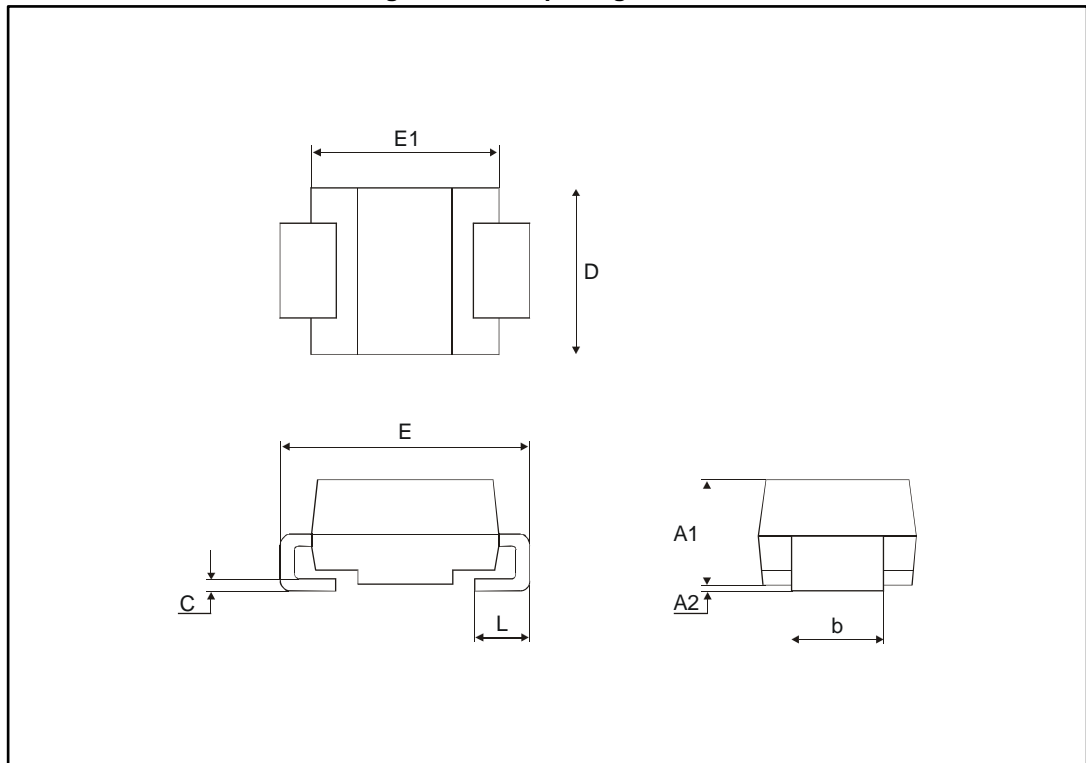
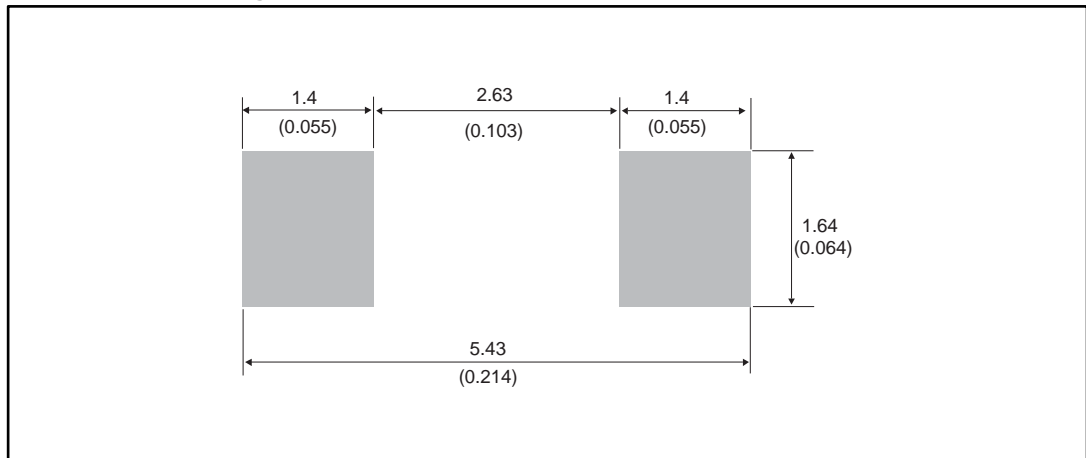

Table 5: SMA package mechanical data

Ref.	Dimensions			
	Millimeters		Inches	
	Min.	Max.	Min.	Max.
A1	1.90	2.45	0.075	0.097
A2	0.05	0.20	0.002	0.008
b	1.25	1.65	0.049	0.065
c	0.15	0.40	0.006	0.016
D	2.25	2.90	0.089	0.114
E	4.80	5.35	0.189	0.211
E1	3.95	4.60	0.156	0.181
L	0.75	1.50	0.030	0.059

Figure 16: SMA recommended footprint in mm (inches)



## 2.2 SMB package information

Figure 17: SMB package outline

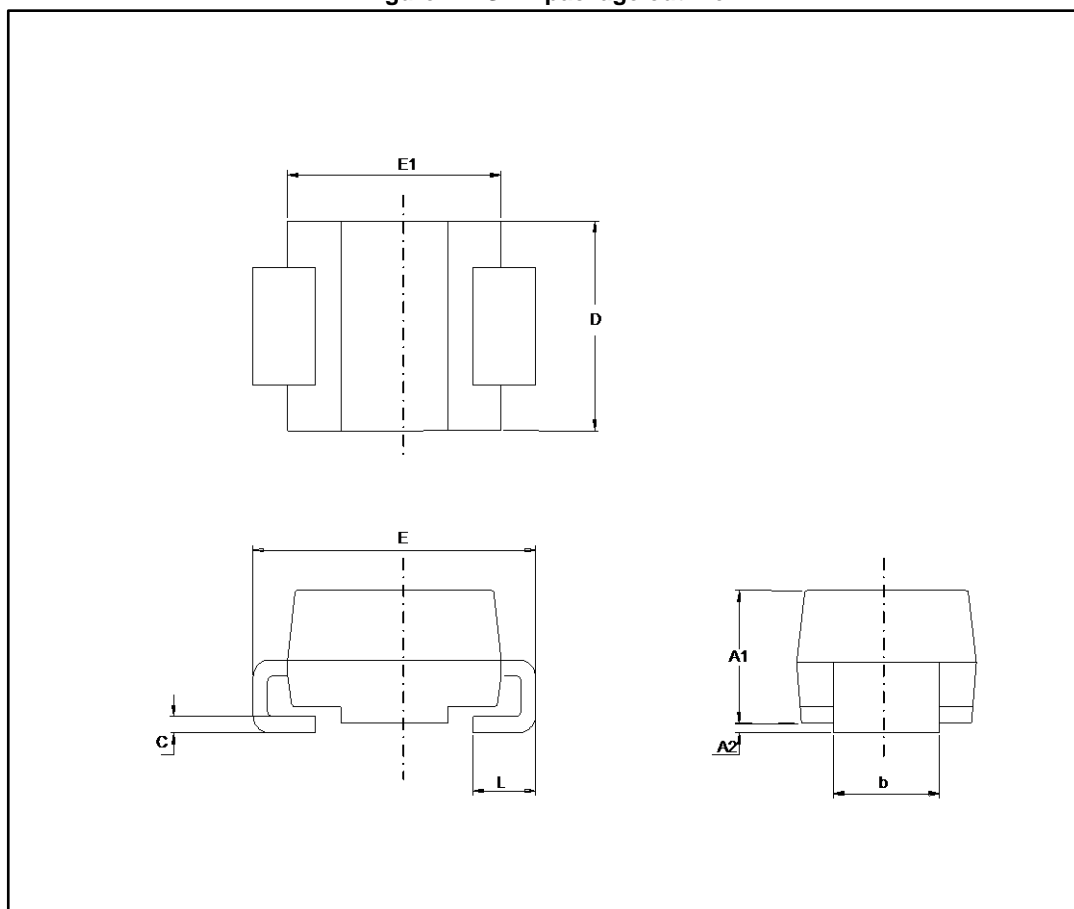
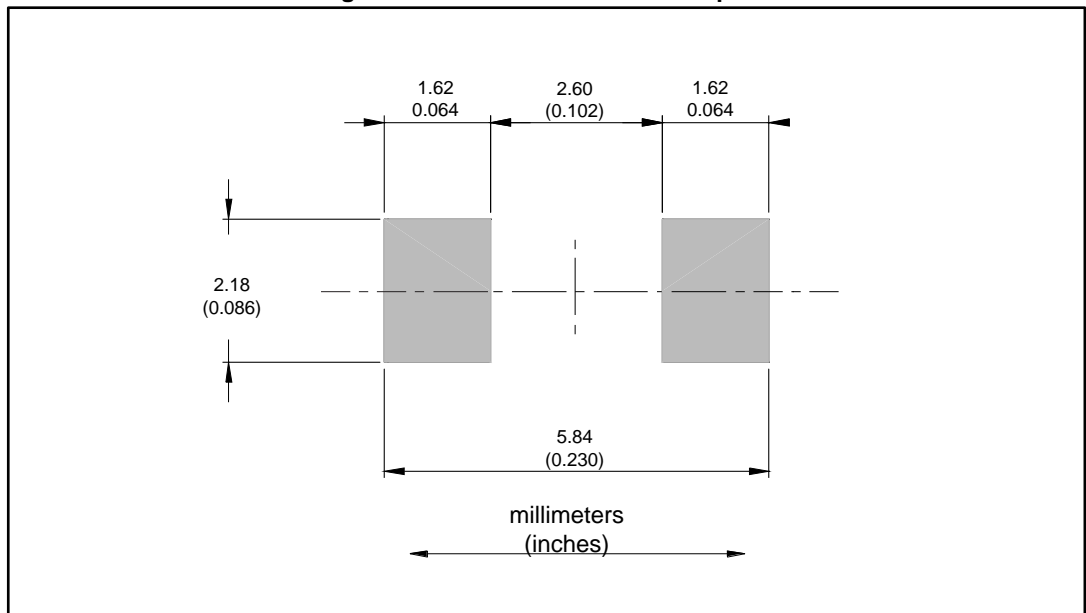

Table 6: SMB package mechanical data

Ref.	Dimensions			
	Millimeters		Inches	
	Min.	Max.	Min.	Max.
A1	1.90	2.45	0.0748	0.0965
A2	0.05	0.20	0.0020	0.0079
b	1.95	2.20	0.0768	0.0867
c	0.15	0.40	0.0059	0.0157
D	3.30	3.95	0.1299	0.1556
E	5.10	5.60	0.2008	0.2205
E1	4.05	4.60	0.1594	0.1811
L	0.75	1.50	0.0295	0.0591



Figure 18: SMB recommended footprint



## 2.3 SOD123Flat package information

Figure 19: SOD123Flat package outline

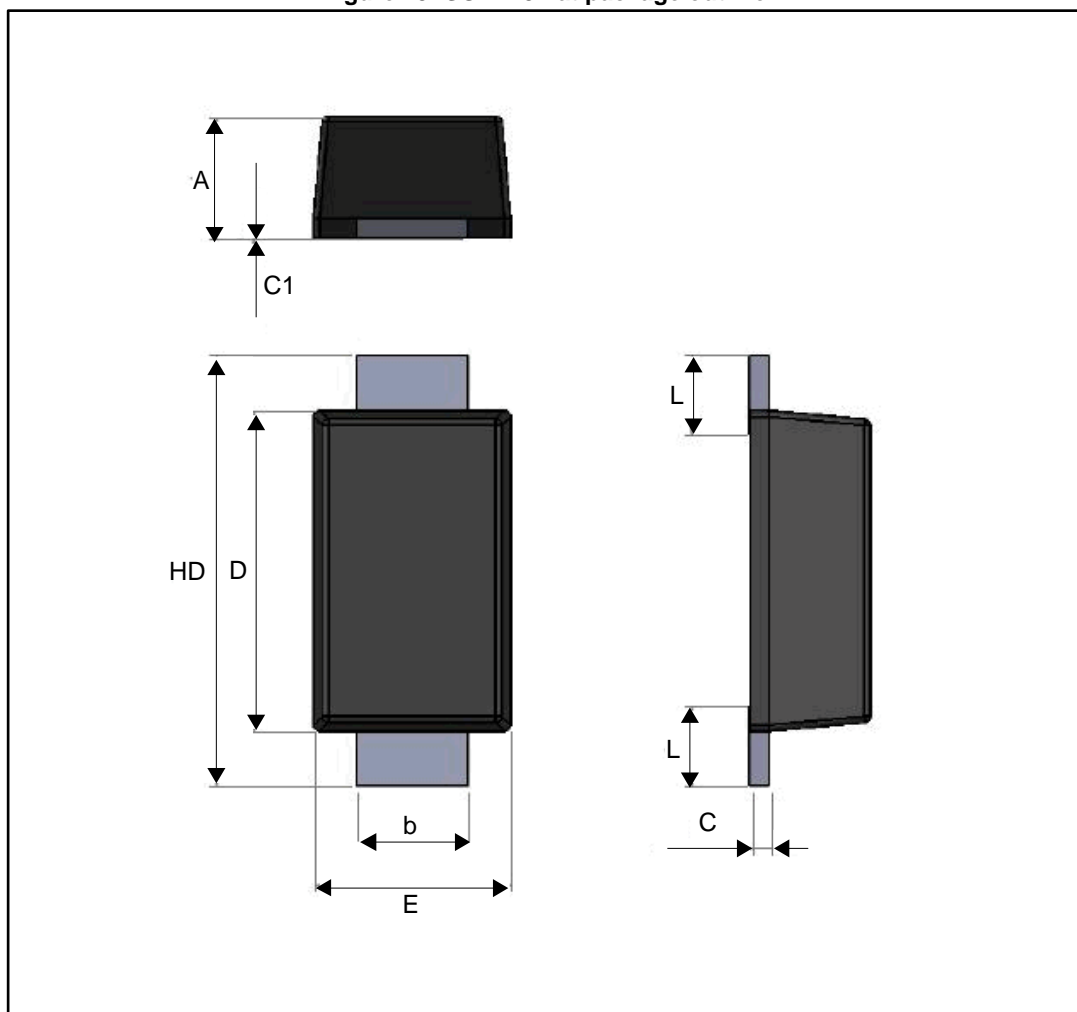
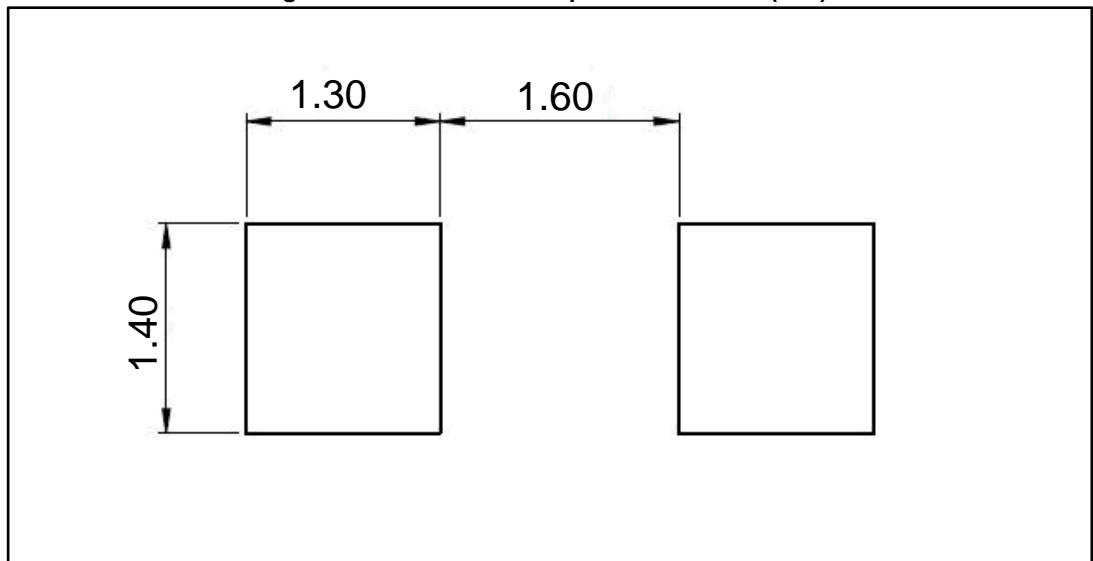

Table 7: SOD123Flat package mechanical data

Ref.	Dimensions		
	Millimeters		
	Min.	Typ.	Max.
A	0.86	0.98	1.10
b	0.80	0.90	1.00
c	0.08	0.15	0.25
c1	0.00		0.10
D	2.50	2.60	2.70
E	1.50	1.60	1.80
HD	3.30	3.50	3.70
L	0.45	0.65	0.85

Figure 20: SOD123Flat footprint dimensions (mm)



### 3 Ordering information

Table 8: Ordering information

Order code	Marking	Package	Weight	Base qty.	Delivery mode
STPS1L40AY	GB4Y	SMA	68 mg	5000	Tape and reel
STPS1L40UY	GC4Y	SMB	107 mg	2500	Tape and reel
STPS1L40ZFY	1Y4	SOD123Flat	12.5 mg	3000	Tape and reel

### 4 Revision history

Table 9: Document revision history

Date	Revision	Changes
21-Oct-2011	1	First issue.
01-Oct-2016	2	Added SOD123Flat package.

**IMPORTANT NOTICE – PLEASE READ CAREFULLY**

STMicroelectronics NV and its subsidiaries ("ST") reserve the right to make changes, corrections, enhancements, modifications, and improvements to ST products and/or to this document at any time without notice. Purchasers should obtain the latest relevant information on ST products before placing orders. ST products are sold pursuant to ST's terms and conditions of sale in place at the time of order acknowledgement.

Purchasers are solely responsible for the choice, selection, and use of ST products and ST assumes no liability for application assistance or the design of Purchasers' products.

No license, express or implied, to any intellectual property right is granted by ST herein.

Resale of ST products with provisions different from the information set forth herein shall void any warranty granted by ST for such product.

ST and the ST logo are trademarks of ST. All other product or service names are the property of their respective owners.

Information in this document supersedes and replaces information previously supplied in any prior versions of this document.

© 2016 STMicroelectronics – All rights reserved

# Mouser Electronics

Authorized Distributor

Click to View Pricing, Inventory, Delivery & Lifecycle Information:

[STMicroelectronics:](#)

[STPS1L40AY](#) [STPS1L40UY](#) [STPS1L40ZFY](#)