



# 80×80×25 mm

San Ace 80W 9WL type   

## General Specifications

- Material ..... Frame: Aluminum (Black coating), Impeller: Plastic (Flammability: UL 94V-1)
- Expected life ..... See the table below. (L10 life: 90% survival rate for continuous operation in indoor free air at 60°C, rated voltage)
- Motor protection function ..... Locked rotor burnout protection, Reverse polarity protection  
For details, please refer to p. 529.
- Dielectric strength ..... 50/60 Hz, 500 VAC, for 1 minute (between lead wire conductors and frame)
- Insulation resistance ..... 10 MΩ or more with a 500 VDC megger (between lead wire conductors and frame)
- Sound pressure level (SPL) ..... At 1 m away from the air inlet
- Storage temperature ..... -30 to +70°C (Non-condensing)
- Lead wire ..... ⊕Red ⊖Black (Sensor) Yellow (Control) Brown
- Mass ..... 150 g
- Ingress protection ..... IP68

## Specifications

The models listed below **have pulse sensors with PWM control function.**

Model no.	Rated voltage [V]	Operating voltage range [V]	PWM duty cycle* [%]	Rated current [A]	Rated input [W]	Rated speed [min <sup>-1</sup> ]	Max. airflow [m <sup>3</sup> /min] [CFM]	Max. static pressure [Pa] [inchH <sub>2</sub> O]	SPL [dB (A)]	Operating temperature [°C]	Expected life [h]		
9WL0812P4J001	12	10.8 to 13.2	100	0.6	7.2	7400	2.07 73.0	177 0.71	49	-20 to +70	180000/60°C		
			20	0.06	0.72	1800	0.5 17.6	10.4 0.04	16				
9WL0812P4G001			100	0.3	3.6	5500	1.54 54.3	98 0.39	43				
			25	0.05	0.6	1400	0.39 13.7	6.3 0.02	14				
9WL0812P4H001			100	0.12	1.44	3700	1.03 36.3	44 0.17	31				
			25	0.04	0.48	1100	0.3 10.5	3.9 0.01	13				
9WL0824P4J001			24	21.6 to 26.4	100	0.28	6.72	7400	2.07 73.0			177 0.71	49
					20	0.05	1.2	2400	0.67 23.6			18.6 0.07	22
9WL0824P4G001					100	0.14	3.36	5500	1.54 54.3			98 0.39	43
					20	0.02	0.48	1200	0.33 11.6			4.6 0.01	13
9WL0824P4H001	100	0.05			1.2	3700	1.03 36.3	44 0.17	31				
	30	0.02			0.48	1100	0.3 10.5	3.9 0.01	13				

\* PWM frequency: 25 kHz. Fan does not rotate when PWM duty cycle is 0%.

Other sensor specifications are available as options. Refer to the index (p. 559).

## Airflow - Static Pressure Characteristics / PWM Duty - Speed Characteristics Example

**9WL0812P4J001** With pulse sensor with PWM control function

PWM duty cycle

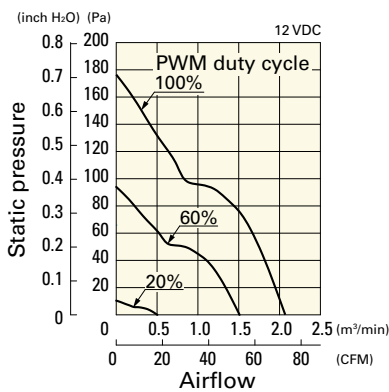

Operating voltage range

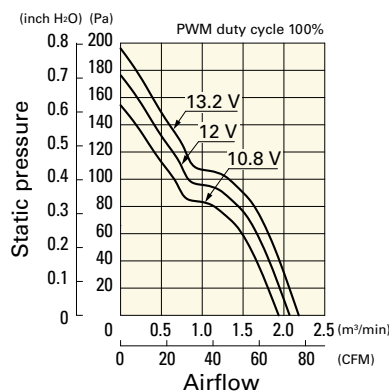

PWM duty - Speed characteristics example

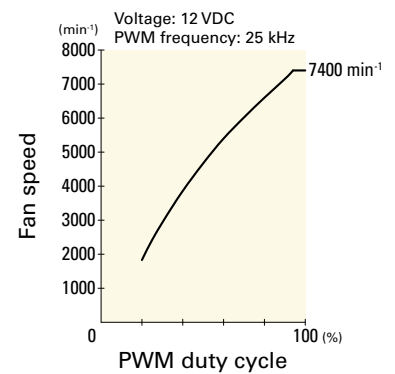

# Airflow - Static Pressure Characteristics / PWM Duty - Speed Characteristics Example

**9WL0812P4G001** With pulse sensor with PWM control function

PWM duty cycle

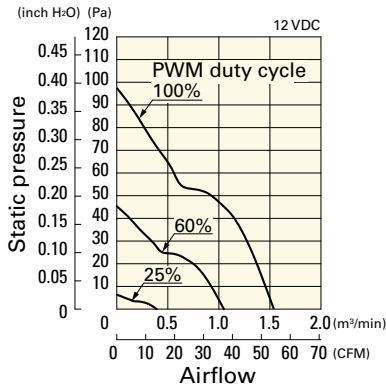

Operating voltage range

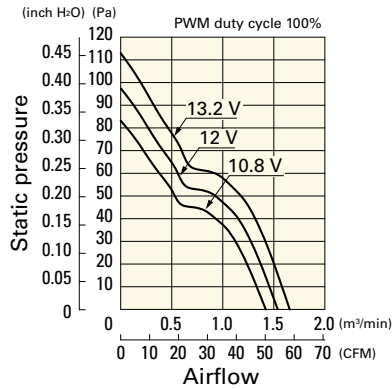

PWM duty - Speed characteristics example

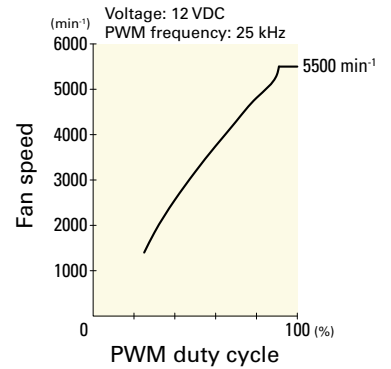

**9WL0812P4H001** With pulse sensor with PWM control function

PWM duty cycle

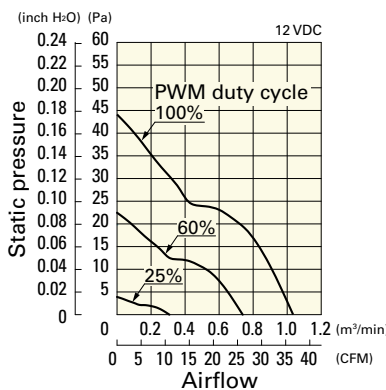

Operating voltage range

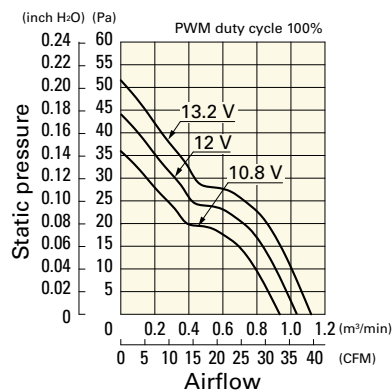

PWM duty - Speed characteristics example

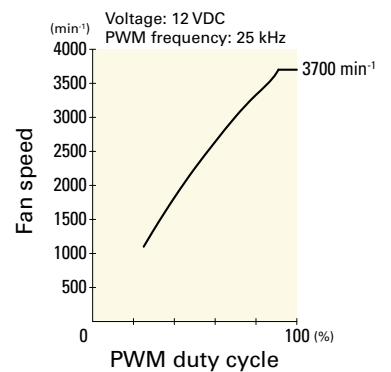

**9WL0824P4J001** With pulse sensor with PWM control function

PWM duty cycle

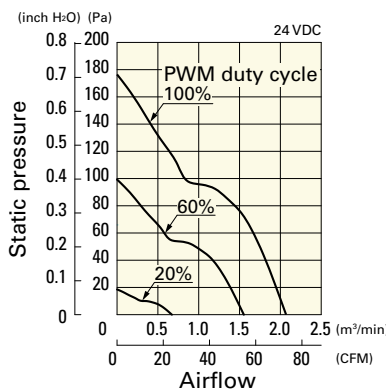

Operating voltage range

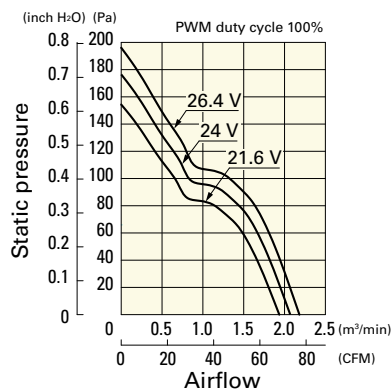

PWM duty - Speed characteristics example

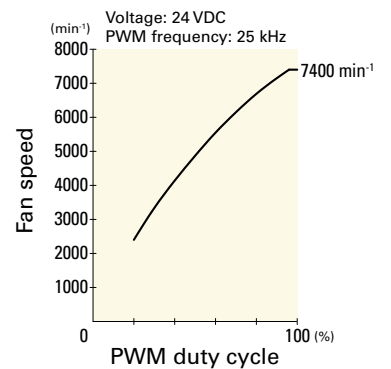

**9WL0824P4G001** With pulse sensor with PWM control function

PWM duty cycle

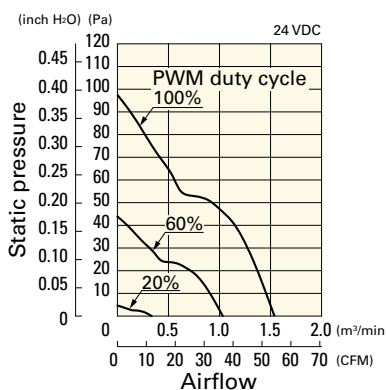

Operating voltage range

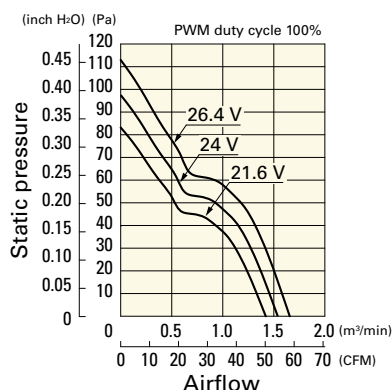

PWM duty - Speed characteristics example

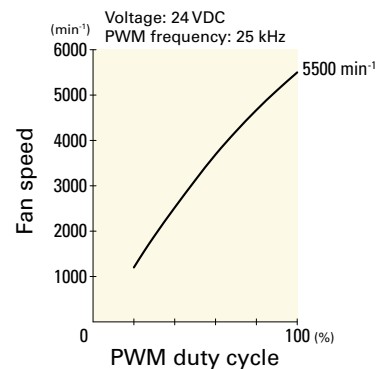

## Airflow - Static Pressure Characteristics / PWM Duty - Speed Characteristics Example

**9WL0824P4H001** With pulse sensor with PWM control function

PWM duty cycle

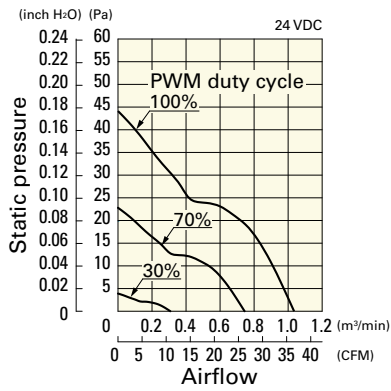

Operating voltage range

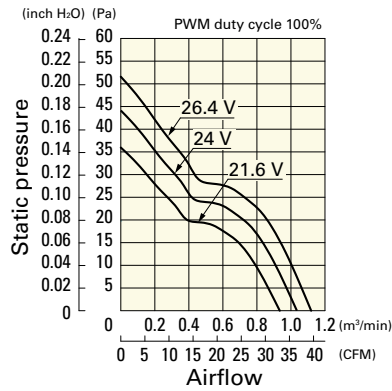

PWM duty - Speed characteristics example

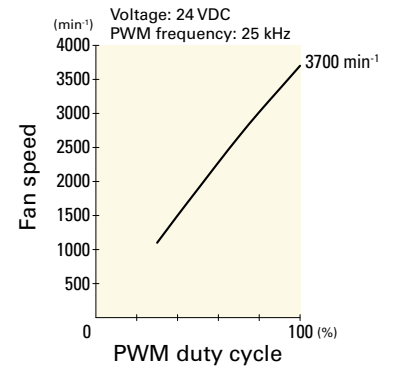

## Dimensions (unit: mm)

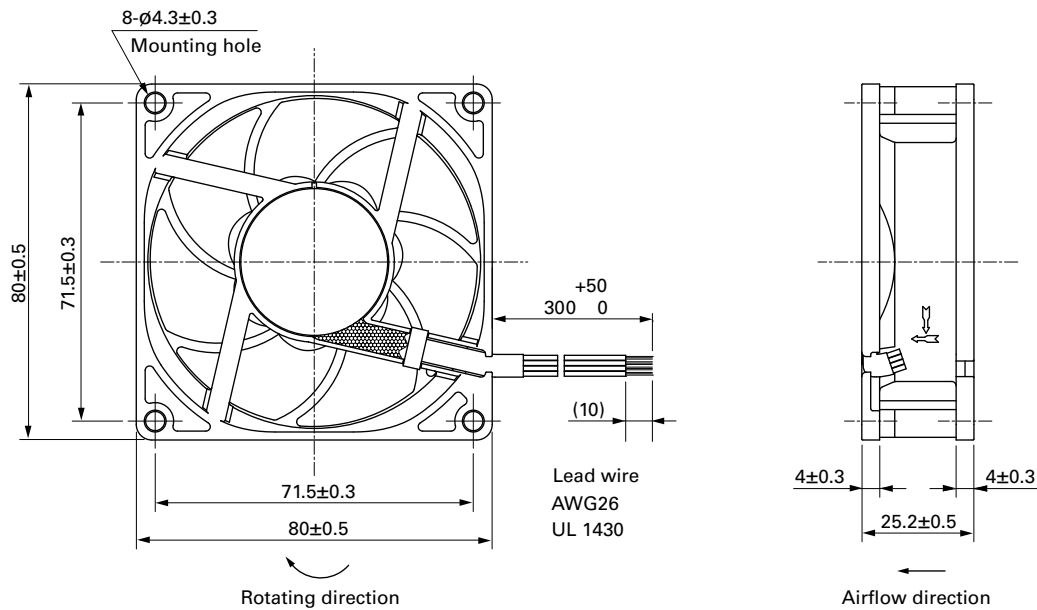

## Reference Dimensions of Mounting Holes and Vent Opening (unit: mm)

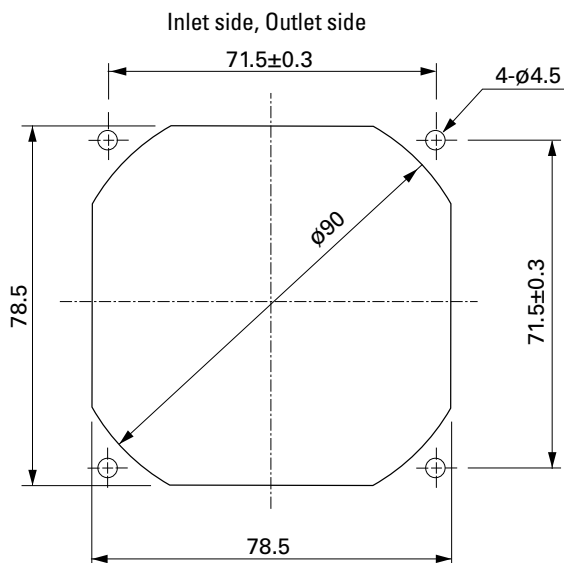

## Options

Finger guards

page: p. 513

Model no.: 109-049C, 109-049E, 109-049H

Resin finger guards

page: p. 520

Model no.: 109-1002G

# Mouser Electronics

Authorized Distributor

Click to View Pricing, Inventory, Delivery & Lifecycle Information:

[Sanyo Denki:](#)

[9WL0812P4J001](#) [9WL0824P4J001](#) [9WL0824P4G001](#) [9WL0812P4G001](#) [9WL0812P4H001](#) [9WL0824P4H001](#)  
[9WL0812G4D001](#)