

Single 2-Input Exclusive-OR Gate

1 Features

- Qualified for Automotive Applications
- AEC-Q100 Qualified With the Following Results:
 - ± 4000 -V Human-Body Model (HBM) ESD Classification Level 3A
 - ± 1000 -V Charged-Device Model (CDM) ESD Classification Level C5
- Operating Range of 2 V to 5.5 V
- Max t_{pd} of 10ns at 5 V
- Low Power Consumption, 10- μ A Max I_{CC}
- ± 8 -mA Output Drive at 5 V
- Schmitt-Trigger Action at All Inputs Makes the Circuit Tolerant for Slower Input Rise and Fall Time

2 Applications

- Wireless Headsets
- Motor Drives and Controls
- TVs
- Set-Top Boxes
- Audio

3 Description

The SN74AHC1G86-Q1 is a single 2-input exclusive-OR gate. The device performs the Boolean function $Y = A \oplus B$ or $Y = \overline{A}B + A\overline{B}$ in positive logic.

A common application is as a true/complement element. If one of the inputs is low, the other input is reproduced in true form at the output. If one of the inputs is high, the signal on the other input is reproduced inverted at the output.

Device Information⁽¹⁾

PART NUMBER	PACKAGE	BODY SIZE (NOM)
SN74AHC1G86QDBVQ1	SOT-23 (5)	2.90 mm x 1.60 mm

(1) For all available packages, see the orderable addendum at the end of the data sheet.

4 Functional Block Diagram



Copyright © 2017, Texas Instruments Incorporated



Table of Contents

1 Features	1	9.1 Overview	8
2 Applications	1	9.2 Functional Block Diagram	8
3 Description	1	9.3 Feature Description	8
4 Functional Block Diagram	1	9.4 Function Table	9
5 Revision History	2	10 Application and Implementation	10
6 Pin Configuration and Functions	3	10.1 Application Information	10
7 Specifications	3	10.2 Typical Application	10
7.1 Absolute Maximum Ratings	3	11 Power Supply Recommendations	11
7.2 ESD Ratings	3	12 Layout	12
7.3 Recommended Operating Conditions	4	12.1 Layout Guidelines	12
7.4 Thermal Information	4	12.2 Layout Example	12
7.5 Electrical Characteristics	5	13 Device and Documentation Support	13
7.6 Switching Characteristics	6	13.1 Receiving Notification of Documentation Updates	13
7.7 Switching Characteristics	6	13.2 Community Resources	13
7.8 Operating Characteristics	6	13.3 Trademarks	13
7.9 Typical Characteristics	6	13.4 Electrostatic Discharge Caution	13
8 Parameter Measurement Information	7	13.5 Glossary	13
9 Detailed Description	8	14 Mechanical, Packaging, and Orderable Information	13

5 Revision History

NOTE: Page numbers for previous revisions may differ from page numbers in the current version.

Changes from Original (April 2011) to Revision A	Page
• Changed Features section	1
• Added Applications section	1
• Changed Description section	1
• Changed Pin Configuration and Functions section	3
• Added T _J spec to Absolute Maximum Ratings table	3
• Changed T _{stg} to -65° (min) and 150°C (max) from -40°C (min) and 125°C (max)	3
• Added ESD Ratings table	3
• Added Thermal Information table	4
• Added Typical Characteristics section	6
• Added Detailed Description section	8
• Added Application and Implementation section	10
• Added Power Supply Recommendations section	11
• Added Layout section	12

6 Pin Configuration and Functions

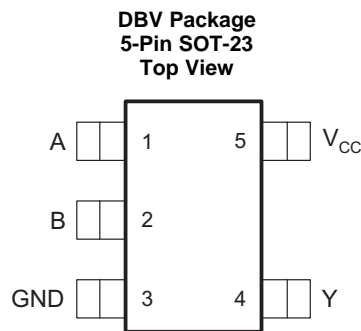

Pin Functions⁽¹⁾

PIN		I/O	DESCRIPTION
NO.	NAME		
1	A	I	Input A
2	B	I	Input B
3	GND	—	Ground
4	Y	O	Output Y
5	V _{CC}	—	Positive Supply

(1) See mechanical drawings for dimensions.

7 Specifications

7.1 Absolute Maximum Ratings

over operating free-air temperature range (unless otherwise noted)

		MIN	MAX	UNIT	
V _{CC}	Supply voltage range	–0.5	7	V	
V _I	Input voltage range ⁽¹⁾	–0.5	7	V	
V _O	Output voltage range applied in the high- or low-state ⁽¹⁾	–0.5	V _{CC} + 0.5	V	
I _{IK}	Input clamp current	V _I < 0 V		–20	V
I _{OK}	Output clamp current	V _O < 0 V or V _O > V _{CC}		±20	mA
I _O	Continuous output current	V _O = 0 V to V _{CC}		±25	mA
	Continuous current through V _{CC} or GND			±50	mA
T _J	Junction temperature			150	°C
T _{stg}	Storage temperature range	–65	150	°C	

(1) The input and output voltage ratings may be exceeded if the input and output current ratings are observed.

7.2 ESD Ratings

		VALUE	UNIT
V _(ESD)	Electrostatic discharge	Human-body model (HBM), per AEC Q100-002 ⁽¹⁾	±4000
		Charged-device model (CDM), per AEC Q100-011	±1000

(1) AEC Q100-002 indicates that HBM stressing shall be in accordance with the ANSI/ESDA/JEDEC JS-001 specification.

7.3 Recommended Operating Conditions

over operating free-air temperature range (unless otherwise noted)

		MIN	MAX	UNIT
V _{CC}	Supply voltage	2	5.5	V
V _{IH}	High-level input voltage	V _{CC} = 2 V	1.5	V
		V _{CC} = 3 V	2.1	
		V _{CC} = 5.5 V	3.85	
V _{IL}	Low-level input voltage	V _{CC} = 2 V	0.5	V
		V _{CC} = 3 V	0.9	
		V _{CC} = 5.5 V	1.65	
V _I	Input voltage	0	5.5	V
V _O	Output voltage	0	V _{CC}	V
I _{OH}	High-level output current	V _{CC} = 2 V	–50	μA
		V _{CC} = 3.3 V ±0.3 V	–4	mA
		V _{CC} = 5 V ±0.5 V	–8	
I _{OL}	Low-level output current	V _{CC} = 2 V	50	μA
		V _{CC} = 3.3 V ±0.3 V	4	mA
		V _{CC} = 5 V ±0.5 V	8	
Δt/ΔV	Input transition rise or fall rate	V _{CC} = 3.3 V ±0.3 V	100	ns/V
		V _{CC} = 5 V ±0.5 V	20	
T _A	Operating free-air temperature	–40	125	°C

7.4 Thermal Information

THERMAL METRIC ⁽¹⁾		SN74AHC1G86-Q1	
		DBV (SOT-23)	
		5 PINS	
			UNIT
R _{θJA}	Junction-to-ambient thermal resistance	224.1	°C/W
R _{θJC(top)}	Junction-to-case (top) thermal resistance	152.8	°C/W
R _{θJB}	Junction-to-board thermal resistance	131.8	°C/W
ψ _{JT}	Junction-to-top characterization parameter	65.7	°C/W
ψ _{JB}	Junction-to-board characterization parameter	131.0	°C/W
R _{θJC(bot)}	Junction-to-case (bottom) thermal resistance	N/A	°C/W

(1) For more information about traditional and new thermal metrics, see the [Semiconductor and IC Package Thermal Metrics](#) application report.

7.5 Electrical Characteristics

over operating free-air temperature range (unless otherwise noted)

PARAMETER	TEST CONDITIONS	V _{CC}	T _A = 25°C			MIN	MAX	UNIT
			MIN	TYP	MAX			
V _{OH}	I _{OH} = -50 μA	2 V	1.9	2		1.9	V	
		3 V	2.9	3		2.9		
		4.5 V	4.4	4.5		4.4		
	I _{OH} = -4 mA	3 V	2.58			2.48		
	I _{OH} = -8 mA	4.5 V	3.94			3.8		
V _{OL}	I _{OL} = 50 μA	2 V			0.1	0.1	V	
		3 V			0.1	0.1		
		4.5 V			0.1	0.1		
	I _{OL} = 4 mA	3 V			0.36	0.44		
	I _{OL} = 8 mA	4.5 V			0.36	0.44		
I _I	V _I = 5.5 V or GND	0 V to 5.5 V			±0.1	±1	μA	
I _{CC}	V _I = V _{CC} or GND, I _O = 0 A	5.5 V			1	10	μA	
C _I	V _I = V _{CC} or GND	5 V		4	10	10	pF	

7.6 Switching Characteristics

over recommended operating free-air temperature range, $V_{CC} = 3.3\text{ V} \pm 0.3\text{ V}$, $T_A = -40^\circ\text{C}$ to 125°C , see

PARAMETER	FROM (INPUT)	TO (OUTPUT)	LOAD CAPACITANCE	$T_A = 25^\circ\text{C}$			MIN	MAX	UNIT
				MIN	TYP	MAX			
t_{PLH}	A or B	Y	$C_L = 50\text{ pF}$	9.5	14.5		1	16.5	ns
t_{PHL}				9.5	14.5		1	16.5	

7.7 Switching Characteristics

over recommended operating free-air temperature range, $V_{CC} = 5\text{ V} \pm 0.5\text{ V}$, $T_A = -40^\circ\text{C}$ to 125°C , see

PARAMETER	FROM (INPUT)	TO (OUTPUT)	LOAD CAPACITANCE	$T_A = 25^\circ\text{C}$			MIN	MAX	UNIT
				MIN	TYP	MAX			
t_{PLH}	A or B	Y	$C_L = 50\text{ pF}$	6.3	8.8		1	10	ns
t_{PHL}				6.3	8.8		1	10	

7.8 Operating Characteristics

$V_{CC} = 5\text{ V}$, $T_A = 25^\circ\text{C}$

PARAMETER	TEST CONDITIONS	TYP	UNIT
C_{pd} Power dissipation capacitance	No load, $f = 1\text{ MHz}$	18	pF

7.9 Typical Characteristics

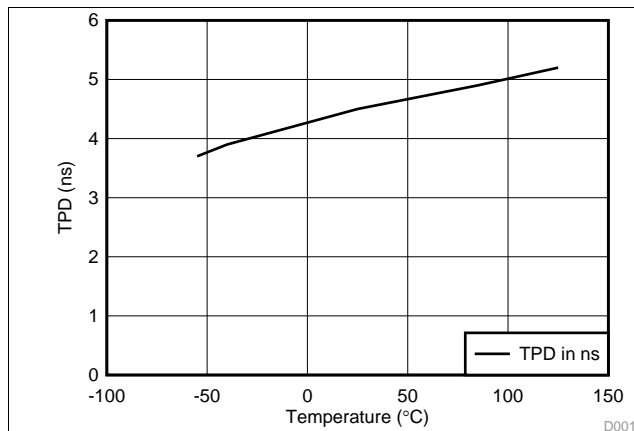

Figure 1. TPD vs Temperature

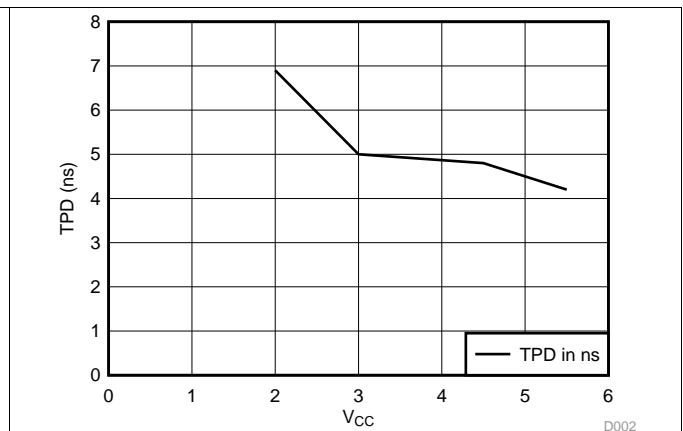
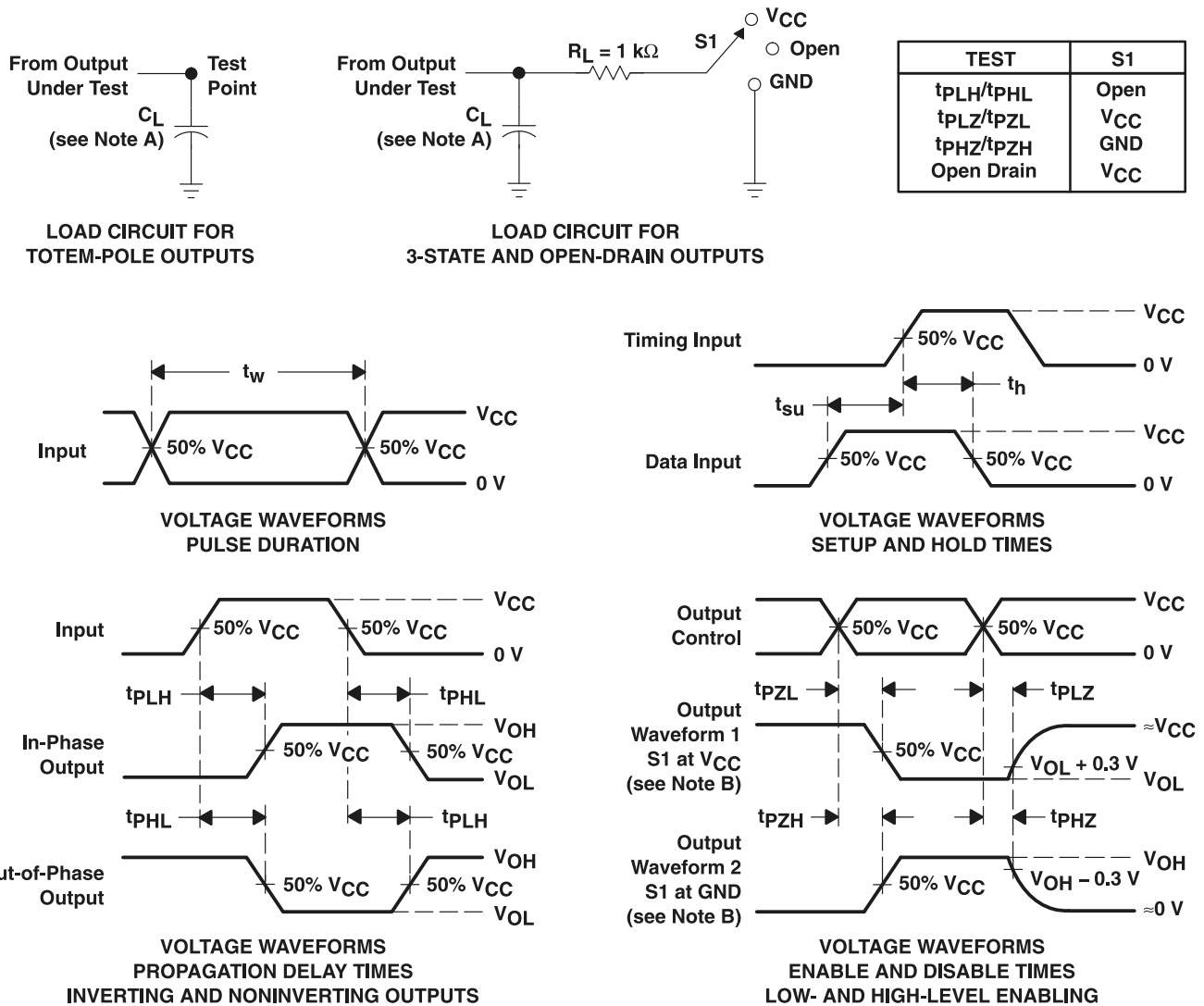

Figure 2. TPD vs V_{CC} at 25°C

8 Parameter Measurement Information



- NOTES: A. C_L includes probe and jig capacitance.
 B. Waveform 1 is for an output with internal conditions such that the output is low, except when disabled by the output control. Waveform 2 is for an output with internal conditions such that the output is high, except when disabled by the output control.
 C. All input pulses are supplied by generators having the following characteristics: PRR \leq 1 MHz, $Z_O = 50\ \Omega$, $t_r \leq 3\text{ ns}$, $t_f \leq 3\text{ ns}$.
 D. The outputs are measured one at a time, with one input transition per measurement.

Figure 3. Load Circuit and Voltage Waveforms

9 Detailed Description

9.1 Overview

The SN74AHC1G86-Q1 is an automotive qualified device that performs the Boolean function $Y = \bar{A}B + A\bar{B}$ in positive logic. This single 2-input exclusive-OR gate is designed for 2-V to 5.5-V V_{CC} operation.

A common application is as a true or complementary element. If one of the inputs is low, the other input is reproduced in true form at the output. If one of the inputs is high, the signal on the other input is reproduced inverted at the output.

9.2 Functional Block Diagram

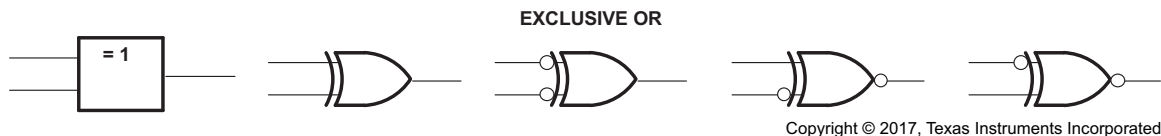

These are five equivalent exclusive-OR symbols valid for an SN74AHC1G86-Q1 gate in positive logic; negation may be shown at any two ports.

9.3 Feature Description

9.3.1 Balanced CMOS Push-Pull Outputs

A balanced output allows the device to sink and source similar currents. The drive capability of this device may create fast edges into light loads so routing and load conditions should be considered to prevent ringing. Additionally, the outputs of this device are capable of driving larger currents than the device can sustain without being damaged. It is important for the output power of the device to be limited to avoid damage due to over-current. The electrical and thermal limits defined in the must be followed at all times.

9.3.2 Standard CMOS Inputs

Standard CMOS inputs are high impedance and are typically modeled as a resistor in parallel with the input capacitance given in the . The worst case resistance is calculated with the maximum input voltage, given in the , and the maximum input leakage current, given in the , using ohm's law ($R = V \div I$).

Signals applied to the inputs need to have fast edge rates, as defined by $\Delta t/\Delta v$ in to avoid excessive current consumption and oscillations. If a slow or noisy input signal is required, a device with a Schmitt-trigger input should be used to condition the input signal prior to the standard CMOS input.

9.3.3 Clamping Diodes

The inputs have negative clamping diodes, and the outputs have positive and negative clamping diodes as depicted in [Figure 4](#).

CAUTION

Voltages beyond the values specified in the table can cause damage to the device. The input negative-voltage and output voltage ratings may be exceeded if the input and output clamp-current ratings are observed.

Feature Description (continued)

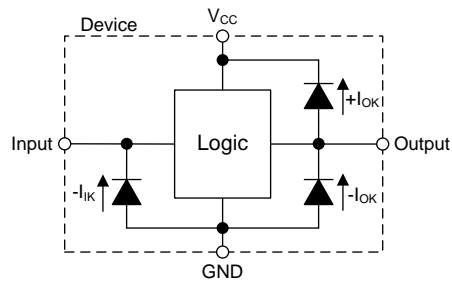

Figure 4. Electrical Placement of Clamping Diodes for Each Input and Output

9.3.4 Over-voltage Tolerant Inputs

Input signals to this device can be driven above the supply voltage so long as they remain below the maximum input voltage value specified in the .

9.4 Function Table

Table 1 lists the functional modes of the SN74AHC1G86-Q1 device.

Table 1. Function Table

INPUTS		OUTPUT Y
A	B	
L	L	L
L	H	H
H	L	H
H	H	L

10 Application and Implementation

NOTE

Information in the following applications sections is not part of the TI component specification, and TI does not warrant its accuracy or completeness. TI's customers are responsible for determining suitability of components for their purposes. Customers should validate and test their design implementation to confirm system functionality.

10.1 Application Information

The SN74AHC1G86-Q1 is a low-drive CMOS device that can be used for a multitude of bus interface type applications where output ringing is a concern. The low drive and slow edge rates will minimize overshoot and undershoot on the outputs. The inputs can accept voltages to 5.5 V at any valid V_{CC} making it ideal for down translation.

10.2 Typical Application

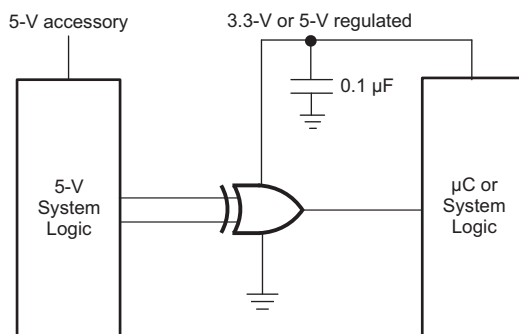

Figure 5. Typical Application Schematic

10.2.1 Design Requirements

This device uses CMOS technology and has balanced output drive. Take care to avoid bus contention because it can drive currents that would exceed maximum limits.

10.2.2 Detailed Design Procedure

1. Recommended Input Conditions
 - For rise time and fall time specifications, see $\Delta t/\Delta V$ in the table.
 - For specified High and low levels, see V_{IH} and V_{IL} in the table.
 - Inputs are overvoltage tolerant allowing them to go as high as 5.5 V at any valid V_{CC} .
2. Recommended Output Conditions
 - Load currents should not exceed 8 mA per output.
 - Outputs should not be pulled above V_{CC} .

Typical Application (continued)

10.2.3 Application Curve

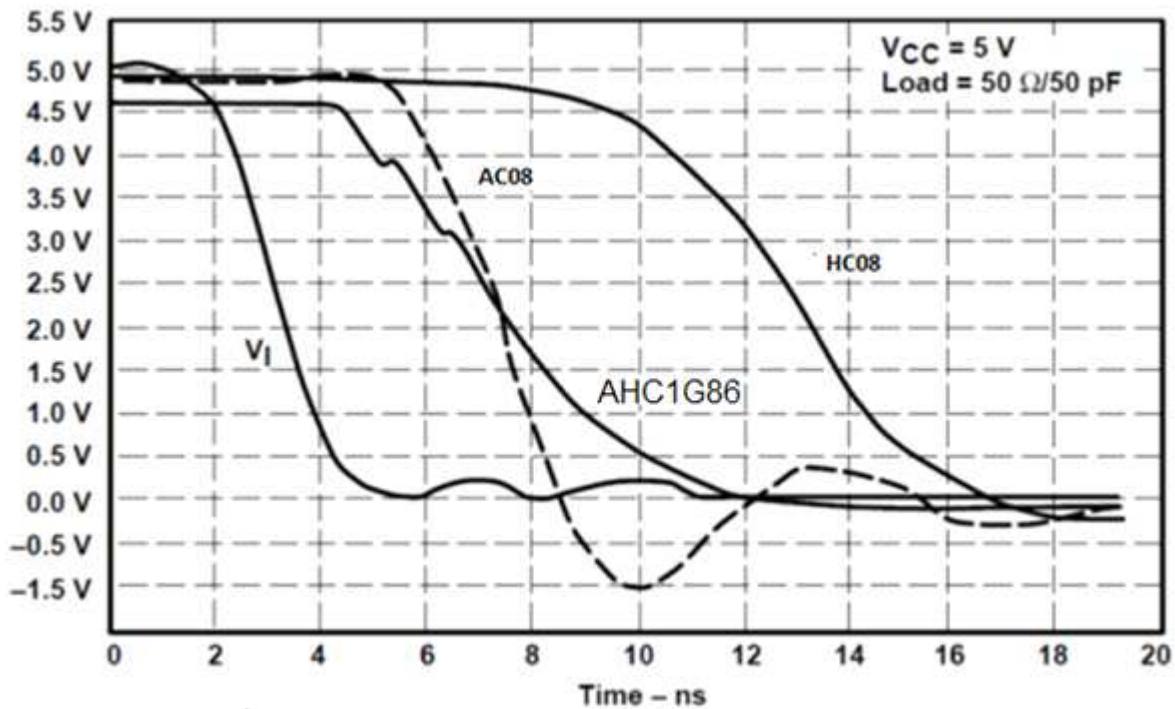

Figure 6. Switching Characteristics Comparison

11 Power Supply Recommendations

The power supply can be any voltage between the minimum and maximum supply voltage rating located in the table.

Each V_{CC} pin must have a good bypass capacitor to prevent power disturbance. For devices with a single supply, 0.1 μF is recommended. If there are multiple V_{CC} pins, 0.01 μF or 0.022 μF is recommended for each power pin. It is acceptable to parallel multiple bypass caps to reject different frequencies of noise. A 0.1- μF and 1- μF are commonly used in parallel. The bypass capacitor must be installed as close to the power pin as possible for best results.

12 Layout

12.1 Layout Guidelines

Even low data rate digital signals can have high frequency signal components due to fast edge rates. When a PCB trace turns a corner at a 90° angle, a reflection can occur. A reflection occurs primarily because of the change of width of the trace. At the apex of the turn, the trace width increases to 1.414 times the width. This increase upsets the transmission-line characteristics, especially the distributed capacitance and self-inductance of the trace which results in the reflection. Not all PCB traces can be straight and therefore some traces must turn corners. shows progressively better techniques of rounding corners. Only the last example (BEST) maintains constant trace width and minimizes reflections.

12.2 Layout Example

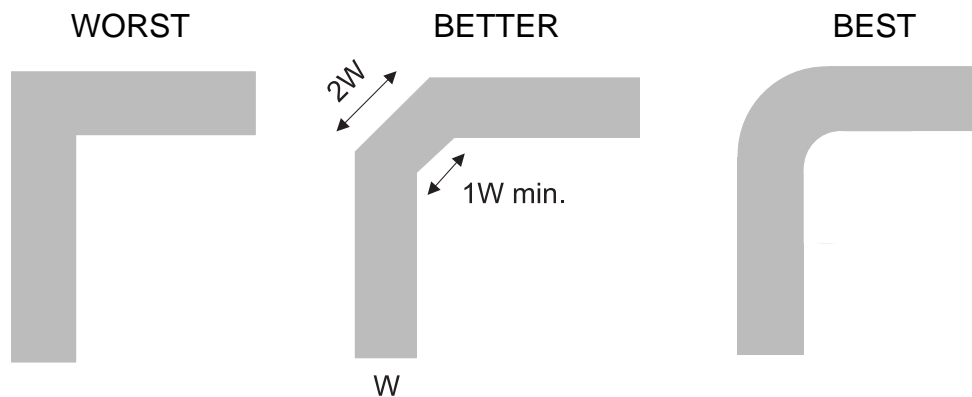

Figure 7. Trace Example

13 Device and Documentation Support

13.1 Receiving Notification of Documentation Updates

To receive notification of documentation updates, navigate to the device product folder on ti.com. In the upper right corner, click on *Alert me* to register and receive a weekly digest of any product information that has changed. For change details, review the revision history included in any revised document.

13.2 Community Resources

The following links connect to TI community resources. Linked contents are provided "AS IS" by the respective contributors. They do not constitute TI specifications and do not necessarily reflect TI's views; see TI's [Terms of Use](#).

TI E2E™ Online Community *TI's Engineer-to-Engineer (E2E) Community*. Created to foster collaboration among engineers. At e2e.ti.com, you can ask questions, share knowledge, explore ideas and help solve problems with fellow engineers.

Design Support *TI's Design Support* Quickly find helpful E2E forums along with design support tools and contact information for technical support.

13.3 Trademarks

E2E is a trademark of Texas Instruments.
All other trademarks are the property of their respective owners.

13.4 Electrostatic Discharge Caution



This integrated circuit can be damaged by ESD. Texas Instruments recommends that all integrated circuits be handled with appropriate precautions. Failure to observe proper handling and installation procedures can cause damage.

ESD damage can range from subtle performance degradation to complete device failure. Precision integrated circuits may be more susceptible to damage because very small parametric changes could cause the device not to meet its published specifications.

13.5 Glossary

[SLYZ022](#) — *TI Glossary*.

This glossary lists and explains terms, acronyms, and definitions.

14 Mechanical, Packaging, and Orderable Information

The following pages include mechanical, packaging, and orderable information. This information is the most current data available for the designated devices. This data is subject to change without notice and revision of this document. For browser-based versions of this data sheet, refer to the left-hand navigation.

PACKAGING INFORMATION

Orderable Device	Status (1)	Package Type	Package Drawing	Pins	Package Qty	Eco Plan (2)	Lead/Ball Finish (6)	MSL Peak Temp (3)	Op Temp (°C)	Device Marking (4/5)	Samples
SN74AHC1G86QDBVRQ1	ACTIVE	SOT-23	DBV	5	3000	Green (RoHS & no Sb/Br)	NIPDAU	Level-1-260C-UNLIM	-40 to 125	ACYU	Samples

(1) The marketing status values are defined as follows:

ACTIVE: Product device recommended for new designs.

LIFEBUY: TI has announced that the device will be discontinued, and a lifetime-buy period is in effect.

NRND: Not recommended for new designs. Device is in production to support existing customers, but TI does not recommend using this part in a new design.

PREVIEW: Device has been announced but is not in production. Samples may or may not be available.

OBSOLETE: TI has discontinued the production of the device.

(2) **RoHS:** TI defines "RoHS" to mean semiconductor products that are compliant with the current EU RoHS requirements for all 10 RoHS substances, including the requirement that RoHS substance do not exceed 0.1% by weight in homogeneous materials. Where designed to be soldered at high temperatures, "RoHS" products are suitable for use in specified lead-free processes. TI may reference these types of products as "Pb-Free".

RoHS Exempt: TI defines "RoHS Exempt" to mean products that contain lead but are compliant with EU RoHS pursuant to a specific EU RoHS exemption.

Green: TI defines "Green" to mean the content of Chlorine (Cl) and Bromine (Br) based flame retardants meet JS709B low halogen requirements of <=1000ppm threshold. Antimony trioxide based flame retardants must also meet the <=1000ppm threshold requirement.

(3) MSL, Peak Temp. - The Moisture Sensitivity Level rating according to the JEDEC industry standard classifications, and peak solder temperature.

(4) There may be additional marking, which relates to the logo, the lot trace code information, or the environmental category on the device.

(5) Multiple Device Markings will be inside parentheses. Only one Device Marking contained in parentheses and separated by a "~" will appear on a device. If a line is indented then it is a continuation of the previous line and the two combined represent the entire Device Marking for that device.

(6) Lead/Ball Finish - Orderable Devices may have multiple material finish options. Finish options are separated by a vertical ruled line. Lead/Ball Finish values may wrap to two lines if the finish value exceeds the maximum column width.

Important Information and Disclaimer: The information provided on this page represents TI's knowledge and belief as of the date that it is provided. TI bases its knowledge and belief on information provided by third parties, and makes no representation or warranty as to the accuracy of such information. Efforts are underway to better integrate information from third parties. TI has taken and continues to take reasonable steps to provide representative and accurate information but may not have conducted destructive testing or chemical analysis on incoming materials and chemicals. TI and TI suppliers consider certain information to be proprietary, and thus CAS numbers and other limited information may not be available for release.

In no event shall TI's liability arising out of such information exceed the total purchase price of the TI part(s) at issue in this document sold by TI to Customer on an annual basis.

OTHER QUALIFIED VERSIONS OF SN74AHC1G86-Q1 :

- Catalog: [SN74AHC1G86](#)
- Enhanced Product: [SN74AHC1G86-EP](#)

NOTE: Qualified Version Definitions:

- Catalog - TI's standard catalog product
- Enhanced Product - Supports Defense, Aerospace and Medical Applications

TAPE AND REEL INFORMATION



QUADRANT ASSIGNMENTS FOR PIN 1 ORIENTATION IN TAPE



*All dimensions are nominal

Device	Package Type	Package Drawing	Pins	SPQ	Reel Diameter (mm)	Reel Width W1 (mm)	A0 (mm)	B0 (mm)	K0 (mm)	P1 (mm)	W (mm)	Pin1 Quadrant
SN74AHC1G86QDBVRQ 1	SOT-23	DBV	5	3000	179.0	8.4	3.2	3.2	1.4	4.0	8.0	Q3

TAPE AND REEL BOX DIMENSIONS



*All dimensions are nominal

Device	Package Type	Package Drawing	Pins	SPQ	Length (mm)	Width (mm)	Height (mm)
SN74AHC1G86QDBVRQ1	SOT-23	DBV	5	3000	203.0	203.0	35.0

DBV0005A



PACKAGE OUTLINE

SOT-23 - 1.45 mm max height

SMALL OUTLINE TRANSISTOR

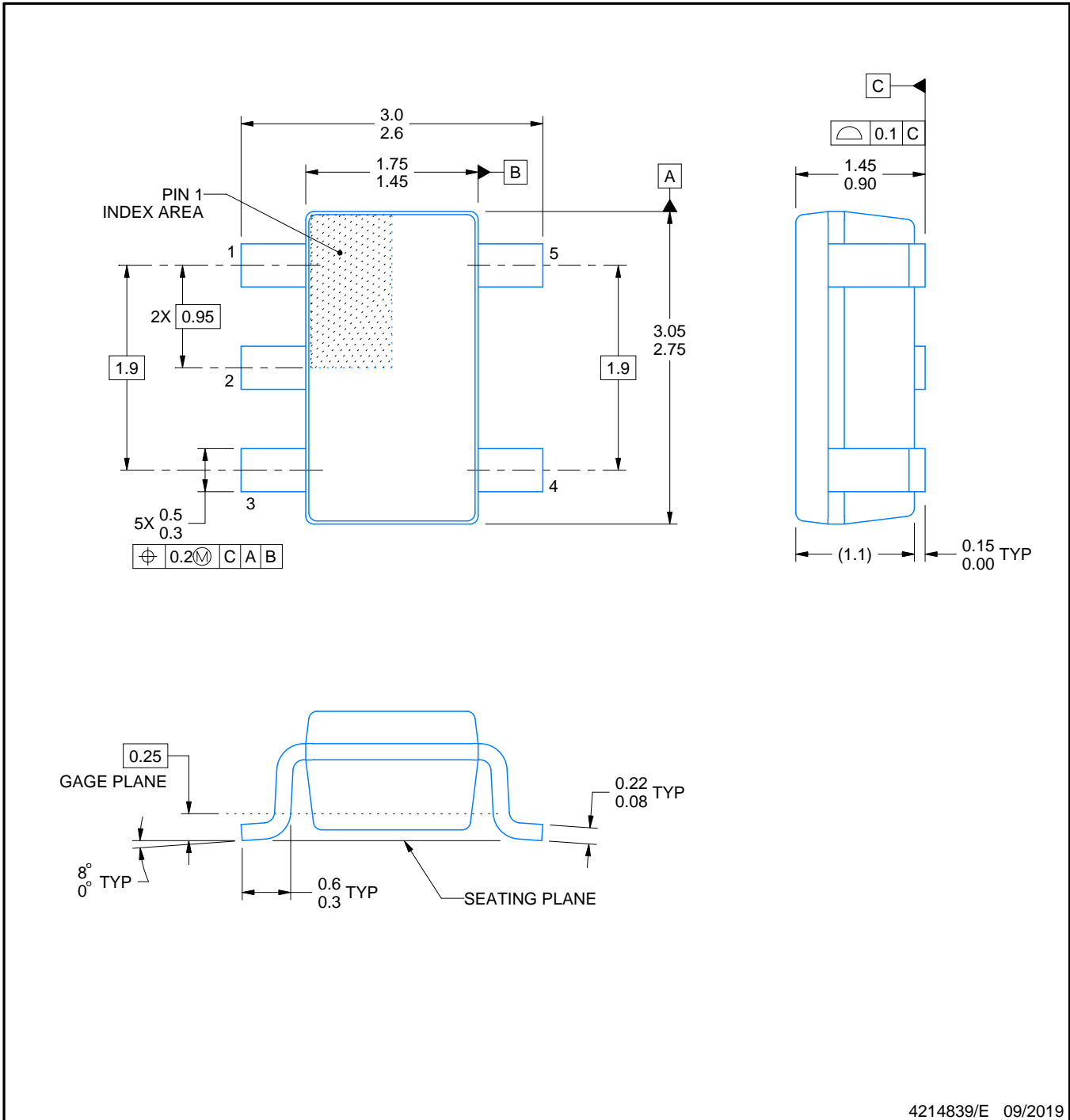

NOTES:

1. All linear dimensions are in millimeters. Any dimensions in parenthesis are for reference only. Dimensioning and tolerancing per ASME Y14.5M.
2. This drawing is subject to change without notice.
3. Reference JEDEC MO-178.
4. Body dimensions do not include mold flash, protrusions, or gate burrs. Mold flash, protrusions, or gate burrs shall not exceed 0.15 mm per side.

EXAMPLE BOARD LAYOUT

DBV0005A

SOT-23 - 1.45 mm max height

SMALL OUTLINE TRANSISTOR



LAND PATTERN EXAMPLE
EXPOSED METAL SHOWN
SCALE:15X



SOLDER MASK DETAILS

4214839/E 09/2019

NOTES: (continued)

- 5. Publication IPC-7351 may have alternate designs.
- 6. Solder mask tolerances between and around signal pads can vary based on board fabrication site.

EXAMPLE STENCIL DESIGN

DBV0005A

SOT-23 - 1.45 mm max height

SMALL OUTLINE TRANSISTOR



SOLDER PASTE EXAMPLE
BASED ON 0.125 mm THICK STENCIL
SCALE:15X

4214839/E 09/2019

NOTES: (continued)

7. Laser cutting apertures with trapezoidal walls and rounded corners may offer better paste release. IPC-7525 may have alternate design recommendations.
8. Board assembly site may have different recommendations for stencil design.

IMPORTANT NOTICE AND DISCLAIMER

TI PROVIDES TECHNICAL AND RELIABILITY DATA (INCLUDING DATASHEETS), DESIGN RESOURCES (INCLUDING REFERENCE DESIGNS), APPLICATION OR OTHER DESIGN ADVICE, WEB TOOLS, SAFETY INFORMATION, AND OTHER RESOURCES "AS IS" AND WITH ALL FAULTS, AND DISCLAIMS ALL WARRANTIES, EXPRESS AND IMPLIED, INCLUDING WITHOUT LIMITATION ANY IMPLIED WARRANTIES OF MERCHANTABILITY, FITNESS FOR A PARTICULAR PURPOSE OR NON-INFRINGEMENT OF THIRD PARTY INTELLECTUAL PROPERTY RIGHTS.

These resources are intended for skilled developers designing with TI products. You are solely responsible for (1) selecting the appropriate TI products for your application, (2) designing, validating and testing your application, and (3) ensuring your application meets applicable standards, and any other safety, security, or other requirements. These resources are subject to change without notice. TI grants you permission to use these resources only for development of an application that uses the TI products described in the resource. Other reproduction and display of these resources is prohibited. No license is granted to any other TI intellectual property right or to any third party intellectual property right. TI disclaims responsibility for, and you will fully indemnify TI and its representatives against, any claims, damages, costs, losses, and liabilities arising out of your use of these resources.

TI's products are provided subject to TI's Terms of Sale (www.ti.com/legal/termsofsale.html) or other applicable terms available either on ti.com or provided in conjunction with such TI products. TI's provision of these resources does not expand or otherwise alter TI's applicable warranties or warranty disclaimers for TI products.

Mailing Address: Texas Instruments, Post Office Box 655303, Dallas, Texas 75265
Copyright © 2020, Texas Instruments Incorporated