



High Precision TCXO / VCTCXO Oscillators

CONNOR WINFIELD



2111 Comprehensive Drive
Aurora, Illinois 60505
Phone: 630-851-4722
Fax: 630-851-5040
www.conwin.com

Description:

The Connor-Winfield M100, M170, and M200 models offer precise frequency stability and excellent phase noise in a 5x3.2mm package.

Through the use of analog temperature compensation, these TCXO's and VCTCXO's are capable of holding sub 100 ppb and 200ppb stabilities over the commercial or industrial temperature ranges.

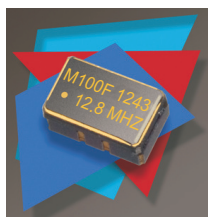

Applications:

Basestation	Communications
DSL / ADSL	Femtocell
IP Timing	LTE
Precision GPS	SONET / SDH
WiMAX / WiBro	WLAN

Features:

- Models: M100, M170, M200 Series**
- Package: 5 x 3.2mm, 8 Pads
 - Frequencies Available: 10, 12.8, 19.2, 19.44, 20.0, 24.576, or 40.0 MHz
 - 3.3 Vdc Operation
 - Output Logic: LVCMOS
 - Frequency Stability:
 - M100: ± 100 ppb, 0 to 70°C
 - M170: ± 100 ppb -20 to 70°C
 - M200: ± 200 ppb, -40 to 85°C
 - Fixed Frequency - TCXO
 - Optional Control Voltage - VCTCXO
 - Low Jitter <0.50 ps RMS
 - Low Phase Noise
 - Tape and Reel Packaging
 - RoHS Compliant / Lead Free

Absolute Maximum Ratings

Parameter	Minimum	Nominal	Maximum	Units	Notes
Storage Temperature	-40	-	85	°C	
Supply Voltage (Vcc)	-0.5	-	4.6	Vdc	
Input Voltage (Vc)	-0.5	-	Vcc + 0.5	Vdc	

Ordering Information

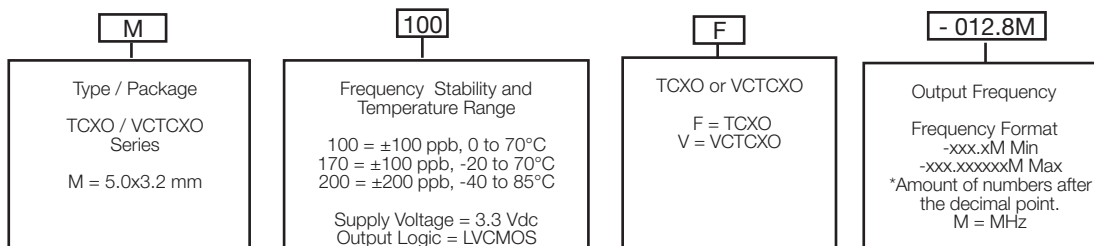

Example: Part Number

M100F-012.8M = 5x3.2mm package, ± 100 ppb, 0 to 70°C, 3.3 Vdc, LVCMOS Output, TCXO, 12.8 MHz
 M100V-019.2M = 5x3.2mm package, ± 100 ppb, 0 to 70°C, 3.3 Vdc, LVCMOS Output, VCTCXO, 19.2 MHz
 M200F-010.0M = 5x3.2mm package, ± 200 ppb, -40 to 85°C, 3.3 Vdc, LVCMOS Output, TCXO, 10 MHz
 M200V-020.0M = 5x3.2mm package, ± 200 ppb, -40 to 85°C, 3.3 Vdc, LVCMOS Output, VCTCXO, 20 MHz





Operating Specifications

Parameter	Minimum	Nominal	Maximum	Units	Notes
Output Frequency (Fo)	10.0, 12.8, 19.2, 19.44, 20.0, 24.576, 40.0			MHz	
Frequency Calibration @ 25 °C	-1.0	-	1.0	ppm	1
Frequency Stability	(See Ordering Information for full part number)				
Model M100x and M170x	-100	-	100	ppb	2
Model M200x	-200	-	200	ppb	2
Frequency vs. Load Stability	-0.20	-	0.20	ppm	±5%
Frequency vs. Voltage Stability	-0.20	-	0.20	ppm	±5%
Static Temperature Hysteresis	-	-	0.40	ppm	3
Freq. shift after reflow soldering	-1.0	-	1.0	ppm	4
Long Term Stability	-1.0	-	1.0	ppm	5
Aging					
per Life (20 Years)	-3.0	-	3.0	ppm	
per Day	-40	-	40	ppb	
per Second	-	4.63E-13	-	pps	
Operating Temperature Range	(See Ordering Information for full part number)				
Model M100x	0	-	70	°C	
Model M170x	-20	-	70	°C	
Model M200x	-40	-	85	°C	
Supply Voltage (Vcc)	3.135	3.30	3.465	Vdc	
Supply Current (Icc)	-	-	3.3	mA	
Jitter:					
Period Jitter	-	3.0	5.0	ps RMS	
Integrated Phase Jitter	-	0.5	1.0	ps RMS	6
SSB Phase Noise for Fo=12.8 MHz					
@ 10 Hz offset	-	-90	-	dBc/Hz	
@ 100 Hz offset	-	-120	-	dBc/Hz	
@ 1 KHz offset	-	-140	-	dBc/Hz	
@ 10 KHz offset	-	-150	-	dBc/Hz	
@ 100 KHz offset	-	-150	-	dBc/Hz	
@ 1 MHz offset	-	-152	-	dBc/Hz	
SSB Phase Noise for Fo=19.2MHz					
@ 10 Hz offset	-	-90	-	dBc/Hz	
@ 100 Hz offset	-	-115	-	dBc/Hz	
@ 1 KHz offset	-	-135	-	dBc/Hz	
@ 10 KHz offset	-	-151	-	dBc/Hz	
@ 100 KHz offset	-	-154	-	dBc/Hz	
@ 1 MHz offset	-	-155	-	dBc/Hz	
Start-Up Time	-	-	10	ms	

Control Voltage Input Characteristics

Parameter	Minimum	Nominal	Maximum	Units	Notes
Control Voltage	0.3	1.65	3.0	V	
Frequency Pullability	±10	-	-	ppm	
Control Voltage Slope	Positive Slope				
Monotonic Linearity	-	-	10	%	
Input Impedance	100K	-	-	Ohm	
Modulation Bandwidth (3dB)	10	-	-	KHz	

LVC MOS Output Characteristics

Parameter	Minimum	Nominal	Maximum	Units	Notes
Load (CL)	-	15	-	pF	7
Voltage (High) (Voh)	90%Vcc	-	-	Vdc	
(Low) (Vol)	-	-	10%Vcc	Vdc	
Duty Cycle at 50% of Vcc	45	50	55	%	
Rise / Fall Time 10% to 90%	-	4	8	ns	

Package Characteristics

Package Hermetically sealed ceramic package with grounded metal cover

Environmental Characteristics

Vibration: Vibration per Mil Std 883E Method 2007.3 Test Condition A.
Shock: Mechanical Shock per Mil Std 883E Method 2002.4 Test Condition B.
Soldering Process: RoHS compliant lead free. See soldering profile on page 2.

- Notes:**
1. Initial calibration @ 25°C. $\pm 2^\circ\text{C}$, for VCTCXO's $V_c = 1.65\text{V}$. Specifications at time of shipment after 48 hours of operation.
 2. Frequency stability vs. change in temperature. $[\pm(F_{\text{max}} - F_{\text{min}})/2.F_0]$. For VCTCXO's - $V_c = 1.65\text{V}$
 3. Frequency change after reciprocal temperature ramped over the operating range. Frequency measured before and after at 25°C
 4. Two consecutive reflows after 1 hour recovery @ 25°C.
 5. Frequency drift over 1 year @ 25°C.
 6. BW = 12 KHz to $F_0/2$
 7. Attention: To achieve optimal frequency stability, and in some cases to meet the specification stated on this data sheet, it is required that the circuit connected to this TCXO output must have the equivalent input capacitance that is specified by the nominal load capacitance. Deviations from the nominal load capacitance will have a graduated effect on the stability of approximately 20 ppb per pF load difference.

M100 - M200 Package Outline

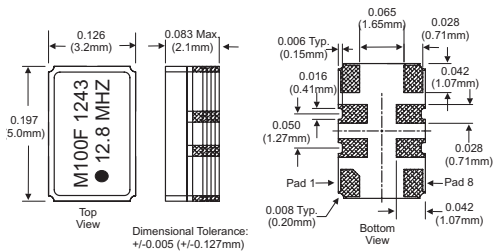

M100 - M200 Suggested Pad Layout

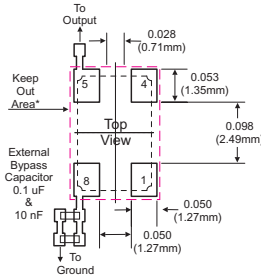

M100 - M200 Pad Connections

- 1: VCTCXO: Control Voltage (V_c)
- TCXO: N/C
- Do Not Connect
- Do Not Connect
- Ground
- Output
- Do Not Connect
- Do Not Connect
- Supply Voltage (V_{cc})

Alternate Package Layout for Select Frequencies

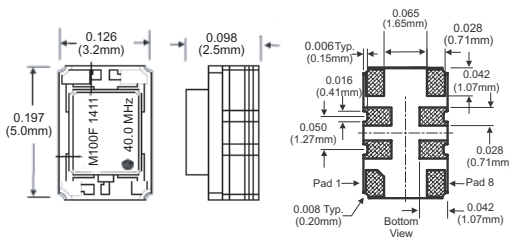

* Do not route any traces in the keep out area. It is recommended the next layer under the keep out area is to be ground plane.

M100 - M200 Design Recommendations

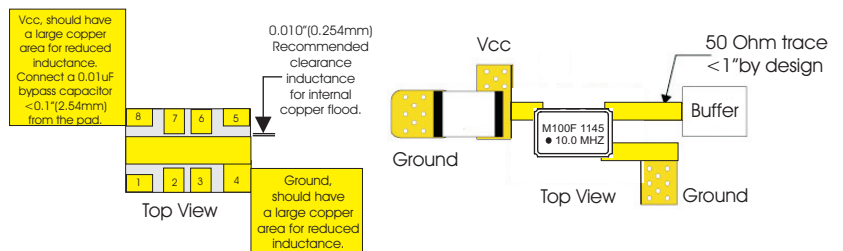

M100 - M200 Test Circuit

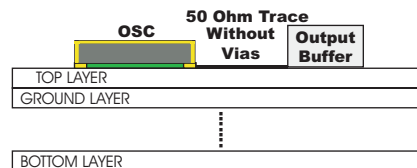
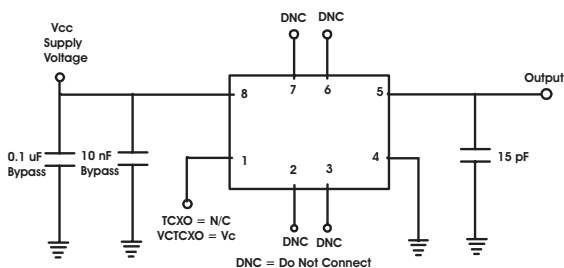

Phase Noise Information

M100V-019.2MHz Typical Phase Noise

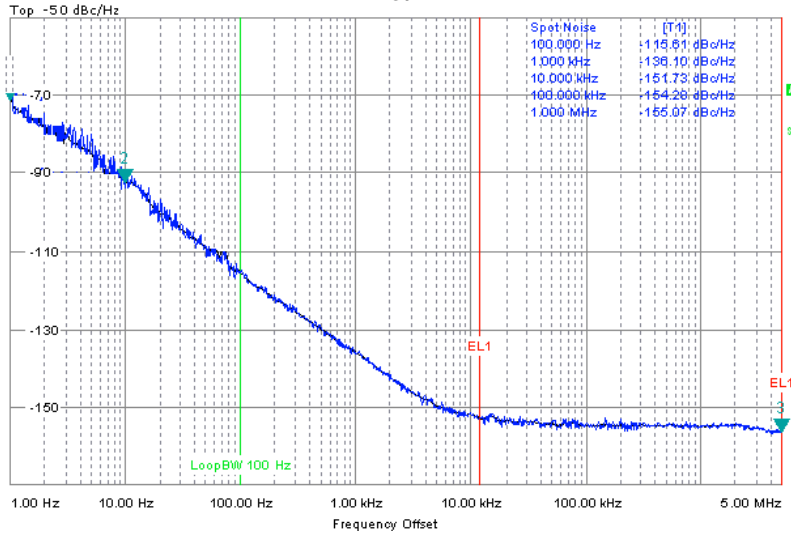

LVCMOS Output Waveform

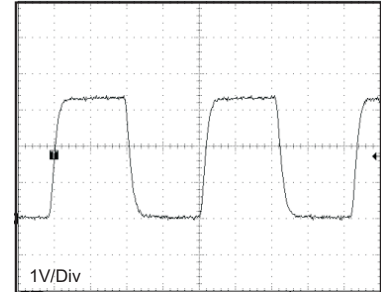

Solder Profile

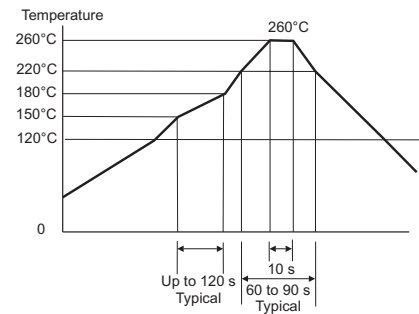

Meets IPC/JEDEC J-STD-020C

Tape and Reel Information

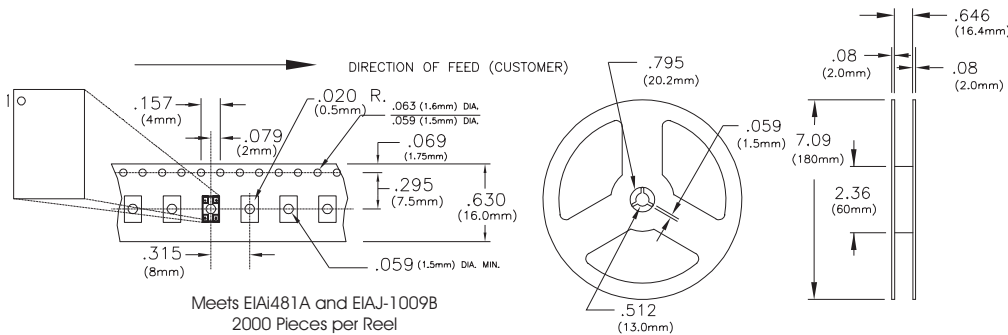

Revision History

Revision	Date	Changes
00	10/31/12	Data sheet released
01	09/02/14	Phase Noise Plot and Specifications Update
02	03/25/15	Updated Frequencies & Alternate Package
03	12/06/17	Added 19.44MHz to available frequency list.

Bulletin	Tx382
Page	4 of 4
Revision	03
Date	06 Dec 2017