

- RoHs Compliant and Halogen Free ①
- Low Profile (<0.6 mm)
- Dual Sided Cooling Compatible ①
- Ultra Low Package Inductance
- Optimized for High Frequency Switching ①
- Ideal for CPU Core DC-DC Converters
- Optimized for Sync. FET socket of Sync. Buck Converter ①
- Low Conduction and Switching Losses
- Compatible with existing Surface Mount Techniques ①
- 100% Rg tested

Typical values (unless otherwise specified)

| V_{DS} | | V_{GS} | | $R_{DS(on)}$ | | $R_{DS(on)}$ | |
|--------------|----------|-----------|----------|--------------|--------------|--------------|--|
| 25V max | | ±20V max | | 1.2mΩ@10V | | 2.0mΩ@4.5V | |
| $Q_{g\ tot}$ | Q_{gd} | Q_{gs2} | Q_{rr} | Q_{oss} | $V_{gs(th)}$ | | |
| 39nC | 12nC | 5.3nC | 28nC | 27nC | 1.9V | | |

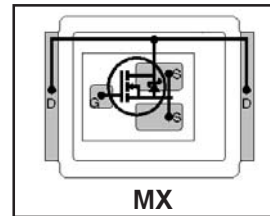

Applicable DirectFET Outline and Substrate Outline (see p.7,8 for details) ①

| | | | | | | | | | | |
|----|----|----|--|----|-----------|----|----|--|--|--|
| SQ | SX | ST | | MQ | MX | MT | MP | | | |
|----|----|----|--|----|-----------|----|----|--|--|--|

Description

The IRF6716MPbF combines the latest HEXFET® Power MOSFET Silicon technology with the advanced DirectFET™ packaging to achieve the lowest on-state resistance in a package that has the footprint of a SO-8 and only 0.6 mm profile. The DirectFET package is compatible with existing layout geometries used in power applications, PCB assembly equipment and vapor phase, infra-red or convection soldering techniques, when application note AN-1035 is followed regarding the manufacturing methods and processes. The DirectFET package allows dual sided cooling to maximize thermal transfer in power systems, improving previous best thermal resistance by 80%.

The IRF6716MPbF balances both low resistance and low charge along with ultra low package inductance to reduce both conduction and switching losses. The reduced total losses make this product ideal for high efficiency DC-DC converters that power the latest generation of processors operating at higher frequencies. The IRF6716MPbF has been optimized for parameters that are critical in synchronous buck including Rds(on), gate charge and Cdv/dt-induced turn on immunity. The IRF6716MPbF offers particularly low Rds(on) and high Cdv/dt immunity for synchronous FET applications.

Absolute Maximum Ratings

| | Parameter | Max. | Units |
|--------------------------|--|------|-------|
| V_{DS} | Drain-to-Source Voltage | 25 | V |
| V_{GS} | Gate-to-Source Voltage | ±20 | |
| $I_D @ T_A = 25^\circ C$ | Continuous Drain Current, $V_{GS} @ 10V$ ③ | 39 | A |
| $I_D @ T_A = 70^\circ C$ | Continuous Drain Current, $V_{GS} @ 10V$ ③ | 31 | |
| $I_D @ T_C = 25^\circ C$ | Continuous Drain Current, $V_{GS} @ 10V$ ④ | 180 | |
| I_{DM} | Pulsed Drain Current ⑤ | 320 | |
| E_{AS} | Single Pulse Avalanche Energy ⑥ | 330 | mJ |
| I_{AR} | Avalanche Current ⑤ | 32 | A |

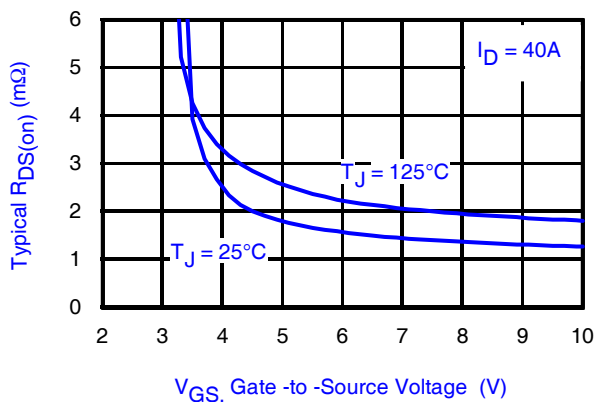

Fig 1. Typical On-Resistance vs. Gate Voltage

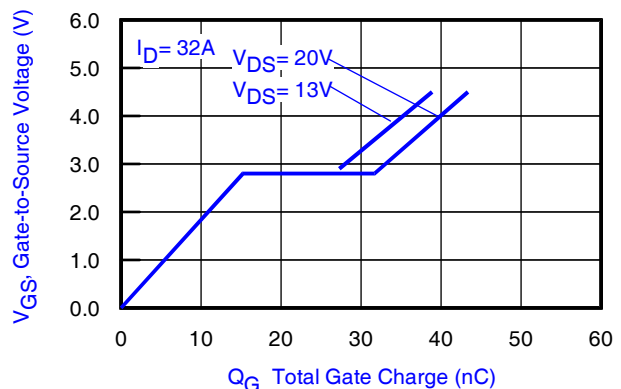

Fig 2. Typical Total Gate Charge vs. Gate-to-Source Voltage

Notes:

- ① Click on this section to link to the appropriate technical paper.
- ② Click on this section to link to the DirectFET Website.
- ③ Surface mounted on 1 in. square Cu board, steady state.

- ④ T_C measured with thermocouple mounted to top (Drain) of part.
- ⑤ Repetitive rating; pulse width limited by max. junction temperature.
- ⑥ Starting $T_J = 25^\circ C$, $L = 0.65mH$, $R_G = 25\Omega$, $I_{AS} = 32A$.

Static @ $T_J = 25^\circ\text{C}$ (unless otherwise specified)

| | Parameter | Min. | Typ. | Max. | Units | Conditions |
|--------------------------------|--------------------------------------|------|------|------|-------|--|
| BV_{DSS} | Drain-to-Source Breakdown Voltage | 25 | — | — | V | $V_{GS} = 0V, I_D = 250\mu A$ |
| $\Delta BV_{DSS}/\Delta T_J$ | Breakdown Voltage Temp. Coefficient | — | 17 | — | mV/°C | Reference to $25^\circ\text{C}, I_D = 1mA$ |
| $R_{DS(on)}$ | Static Drain-to-Source On-Resistance | — | 1.2 | 1.6 | mΩ | $V_{GS} = 10V, I_D = 40A$ ① |
| | | — | 2.0 | 2.6 | | $V_{GS} = 4.5V, I_D = 32A$ ① |
| $V_{GS(th)}$ | Gate Threshold Voltage | 1.4 | 1.9 | 2.4 | V | $V_{DS} = V_{GS}, I_D = 100\mu A$ |
| $\Delta V_{GS(th)}/\Delta T_J$ | Gate Threshold Voltage Coefficient | — | -6.1 | — | mV/°C | |
| I_{DSS} | Drain-to-Source Leakage Current | — | — | 1.0 | μA | $V_{DS} = 25V, V_{GS} = 0V$ |
| | | — | — | 150 | | $V_{DS} = 25V, V_{GS} = 0V, T_J = 125^\circ\text{C}$ |
| I_{GSS} | Gate-to-Source Forward Leakage | — | — | 100 | nA | $V_{GS} = 20V$ |
| | Gate-to-Source Reverse Leakage | — | — | -100 | | $V_{GS} = -20V$ |
| gfs | Forward Transconductance | 220 | — | — | S | $V_{DS} = 15V, I_D = 32A$ |
| Q_g | Total Gate Charge | — | 39 | 59 | nC | $V_{DS} = 13V$ $V_{GS} = 4.5V$ $I_D = 32A$ See Fig. 2 |
| Q_{gs1} | Pre-Vth Gate-to-Source Charge | — | 10 | — | | |
| Q_{gs2} | Post-Vth Gate-to-Source Charge | — | 5.3 | — | | |
| Q_{gd} | Gate-to-Drain Charge | — | 12 | — | | |
| Q_{godr} | Gate Charge Overdrive | — | 11.7 | — | | |
| Q_{sw} | Switch Charge ($Q_{gs2} + Q_{gd}$) | — | 17.3 | — | | |
| Q_{oss} | Output Charge | — | 27 | — | nC | $V_{DS} = 16V, V_{GS} = 0V$ |
| R_G | Gate Resistance | — | 1.0 | 1.6 | Ω | |
| $t_{d(on)}$ | Turn-On Delay Time | — | 26 | — | ns | $V_{DD} = 13V, V_{GS} = 4.5V$ ① $I_D = 32A$ $R_G = 1.8\Omega$ See Fig. 17 |
| t_r | Rise Time | — | 105 | — | | |
| $t_{d(off)}$ | Turn-Off Delay Time | — | 25 | — | | |
| t_f | Fall Time | — | 41 | — | | |
| C_{iss} | Input Capacitance | — | 5150 | — | | |
| C_{oss} | Output Capacitance | — | 1340 | — | pF | $V_{GS} = 0V$ $V_{DS} = 13V$ $f = 1.0MHz$ |
| C_{rss} | Reverse Transfer Capacitance | — | 610 | — | | |

Diode Characteristics

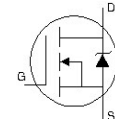
| | Parameter | Min. | Typ. | Max. | Units | Conditions |
|----------|---|------|------|------|-------|--|
| I_S | Continuous Source Current (Body Diode) | — | — | 4.5 | A | MOSFET symbol showing the integral reverse p-n junction diode.  |
| I_{SM} | Pulsed Source Current (Body Diode) ② | — | — | 320 | | |
| V_{SD} | Diode Forward Voltage | — | — | 1.0 | V | $T_J = 25^\circ\text{C}, I_S = 32A, V_{GS} = 0V$ ① |
| t_{rr} | Reverse Recovery Time | — | 28 | 42 | ns | $T_J = 25^\circ\text{C}, I_F = 32A$ |
| Q_{rr} | Reverse Recovery Charge | — | 28 | 42 | nC | $di/dt = 200A/\mu s$ ① |

Notes:

① Pulse width $\leq 400\mu s$; duty cycle $\leq 2\%$.

② Repetitive rating; pulse width limited by max. junction temperature.

Absolute Maximum Ratings

| | Parameter | Max. | Units |
|--------------------------------|----------------------------|--------------|-------|
| $P_D @ T_A = 25^\circ\text{C}$ | Power Dissipation ① | 3.6 | W |
| $P_D @ T_A = 70^\circ\text{C}$ | Power Dissipation ① | 2.3 | |
| $P_D @ T_C = 25^\circ\text{C}$ | Power Dissipation ④ | 78 | |
| T_P | Peak Soldering Temperature | 270 | °C |
| T_J | Operating Junction and | -40 to + 150 | |
| T_{STG} | Storage Temperature Range | | |

Thermal Resistance

| | Parameter | Typ. | Max. | Units |
|--------------------|--------------------------|-------|------|-------|
| $R_{\theta JA}$ | Junction-to-Ambient ①⑤ | — | 35 | °C/W |
| $R_{\theta JA}$ | Junction-to-Ambient ②⑤ | 12.5 | — | |
| $R_{\theta JA}$ | Junction-to-Ambient ③⑤ | 20 | — | |
| $R_{\theta JC}$ | Junction-to-Case ④⑤ | — | 1.6 | |
| $R_{\theta J-PCB}$ | Junction-to-PCB Mounted | 1.0 | — | |
| | Linear Derating Factor ① | 0.031 | | W/°C |

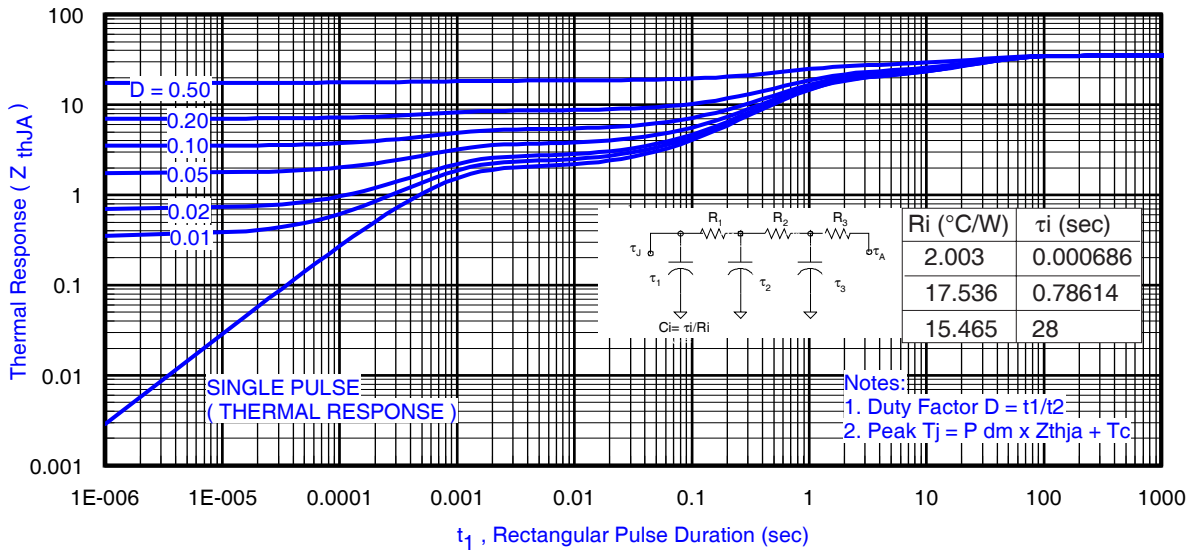
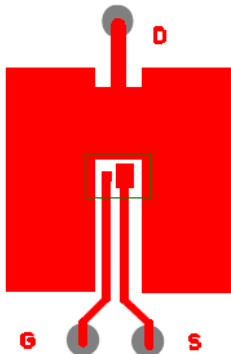

Fig 3. Maximum Effective Transient Thermal Impedance, Junction-to-Ambient ①

Notes:

- ① Surface mounted on 1 in. square Cu board, steady state.
- ② Used double sided cooling, mounting pad.
- ③ Mounted on minimum footprint full size board with metalized back and with small clip heatsink.
- ④ T_C measured with thermocouple incontact with top (Drain) of part.
- ⑤ R_{θ} is measured at T_J of approximately 90°C .



① Surface mounted on 1 in. square Cu (still air).

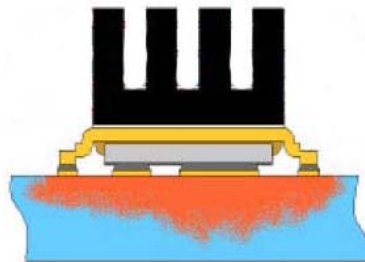

② Mounted to a PCB with small clip heatsink (still air)

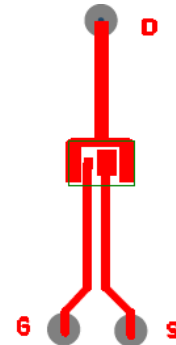

③ Mounted on minimum footprint full size board with metalized back and with small clip heatsink (still air)

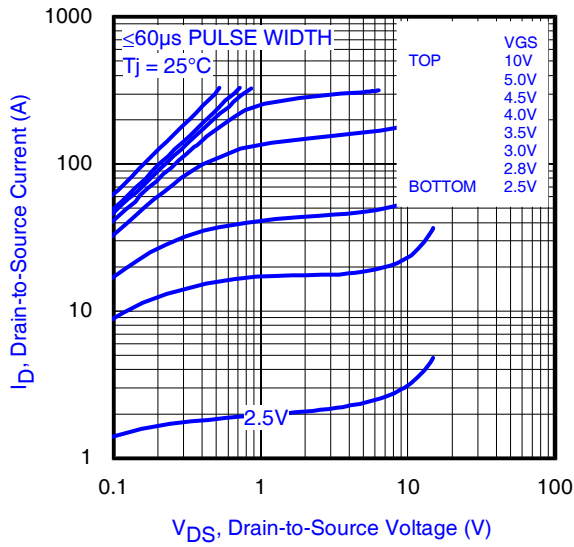

Fig 4. Typical Output Characteristics

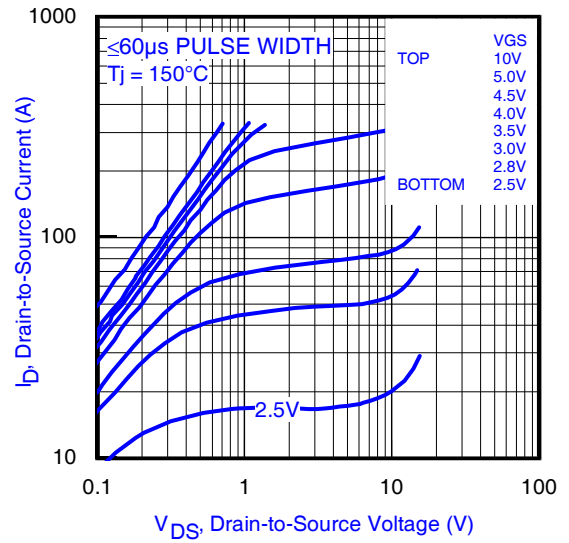

Fig 5. Typical Output Characteristics

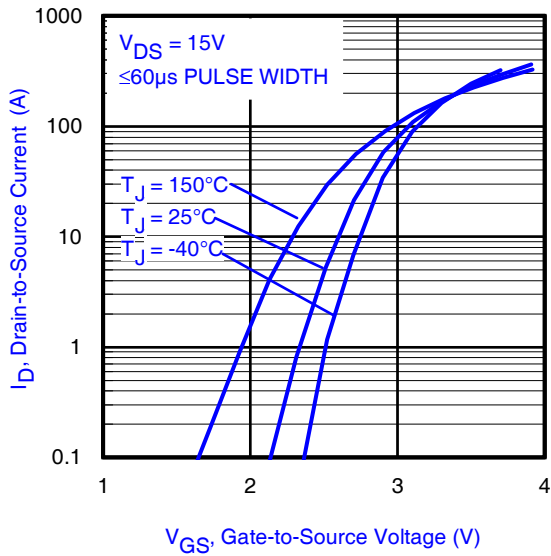

Fig 6. Typical Transfer Characteristics

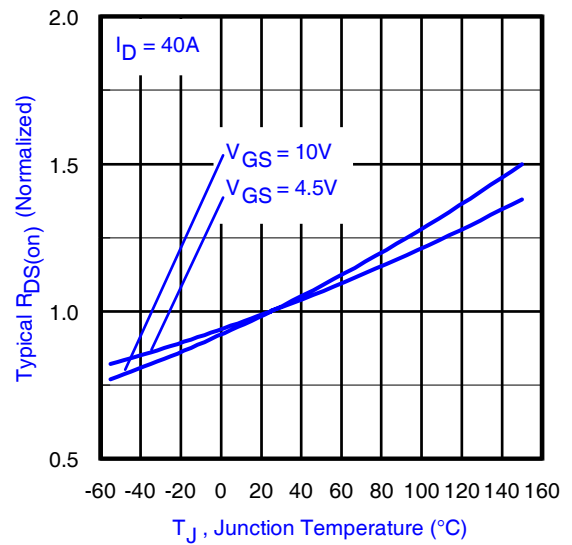

Fig 7. Normalized On-Resistance vs. Temperature

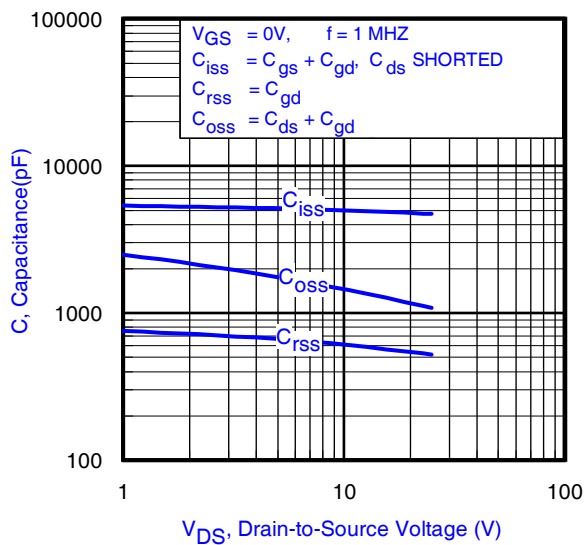

Fig 8. Typical Capacitance vs. Drain-to-Source Voltage

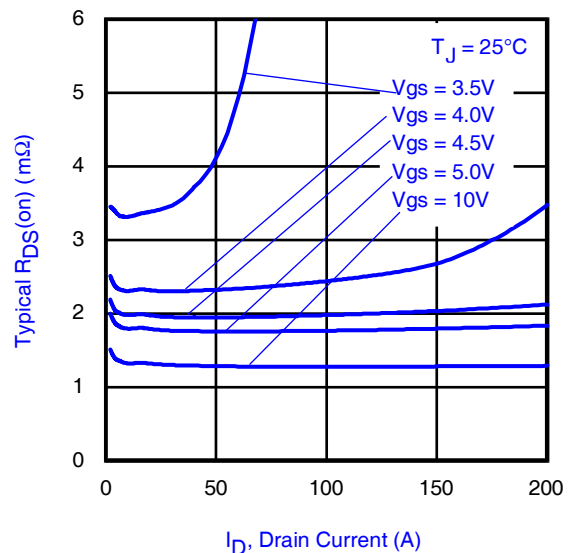

Fig 9. Typical On-Resistance vs. Drain Current and Gate Voltage

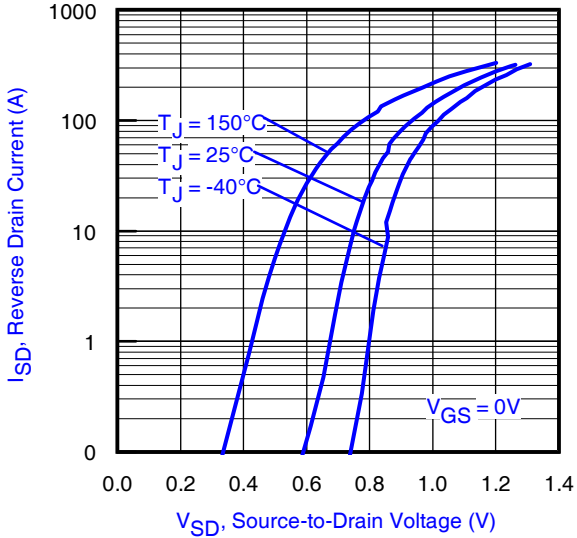

Fig 10. Typical Source-Drain Diode Forward Voltage

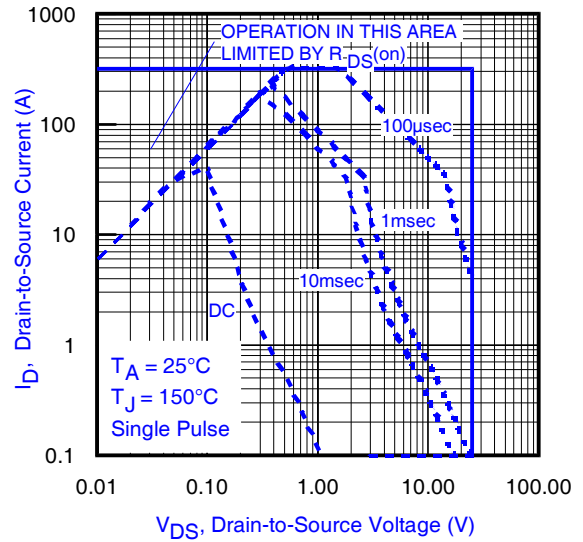

Fig 11. Maximum Safe Operating Area

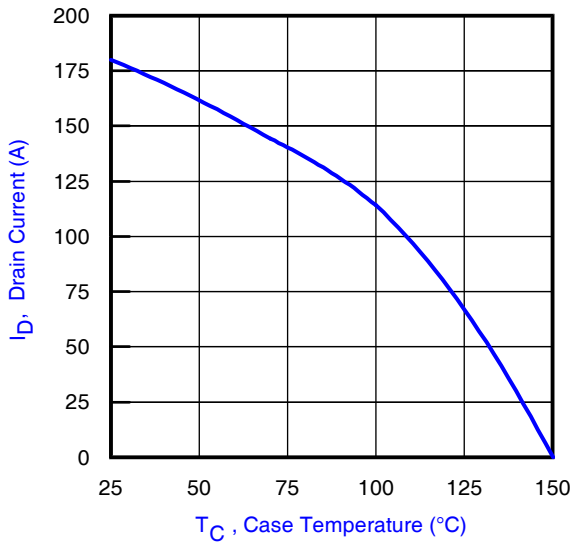

Fig 12. Maximum Drain Current vs. Case Temperature

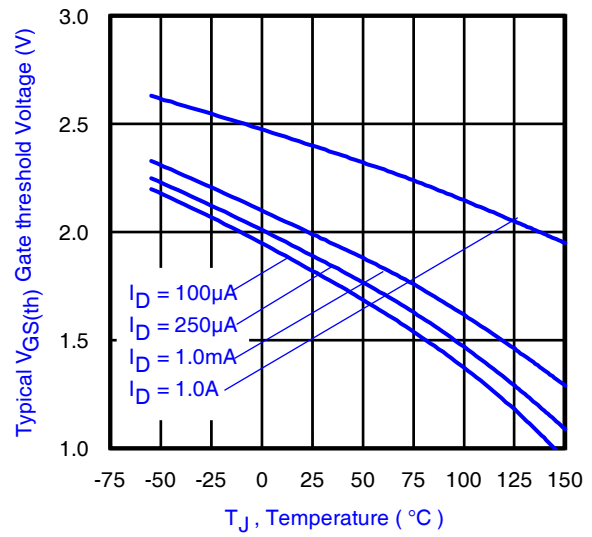

Fig 13. Typical Threshold Voltage vs. Junction Temperature

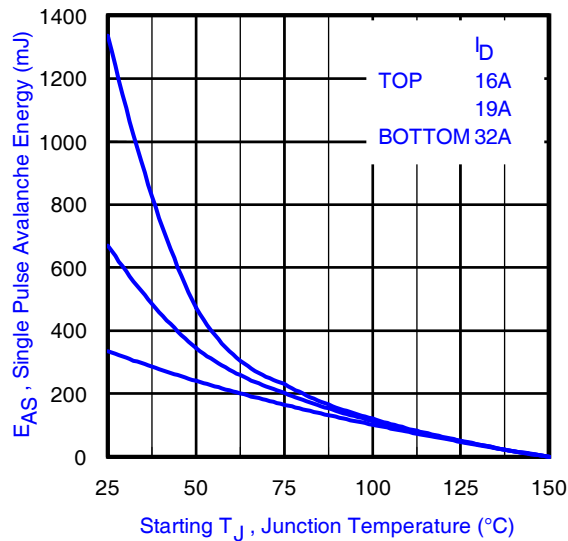

Fig 14. Maximum Avalanche Energy vs. Drain Current

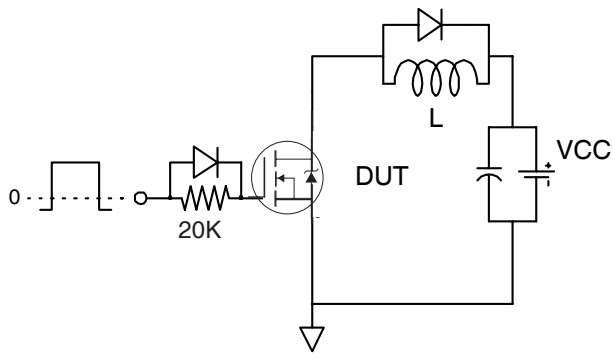

Fig 15a. Gate Charge Test Circuit

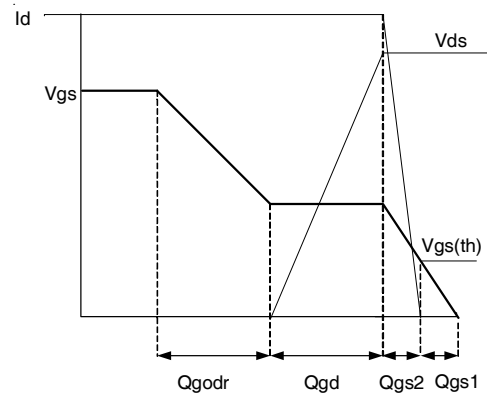

Fig 15b. Gate Charge Waveform

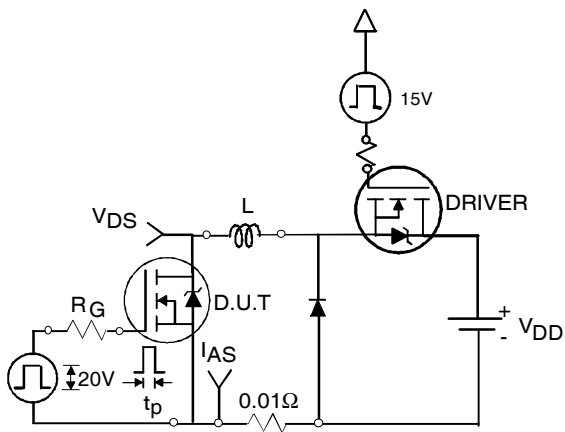

Fig 16a. Unclamped Inductive Test Circuit

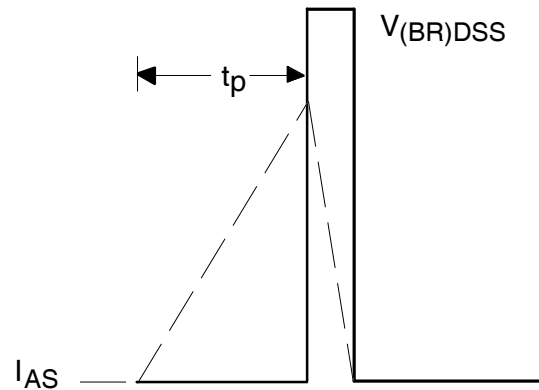

Fig 16b. Unclamped Inductive Waveforms

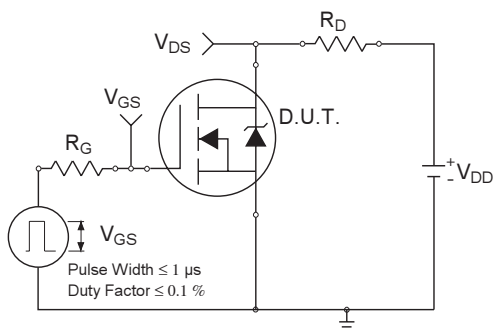

Fig 17a. Switching Time Test Circuit

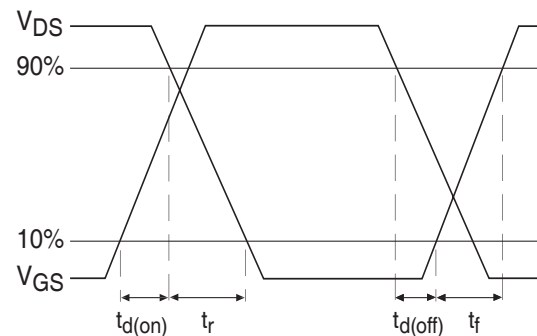

Fig 17b. Switching Time Waveforms

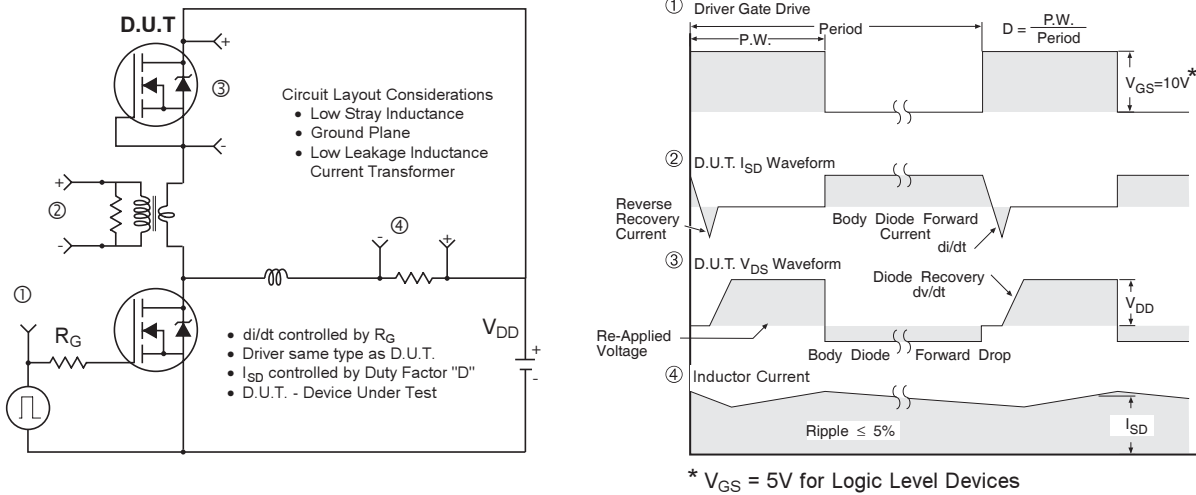
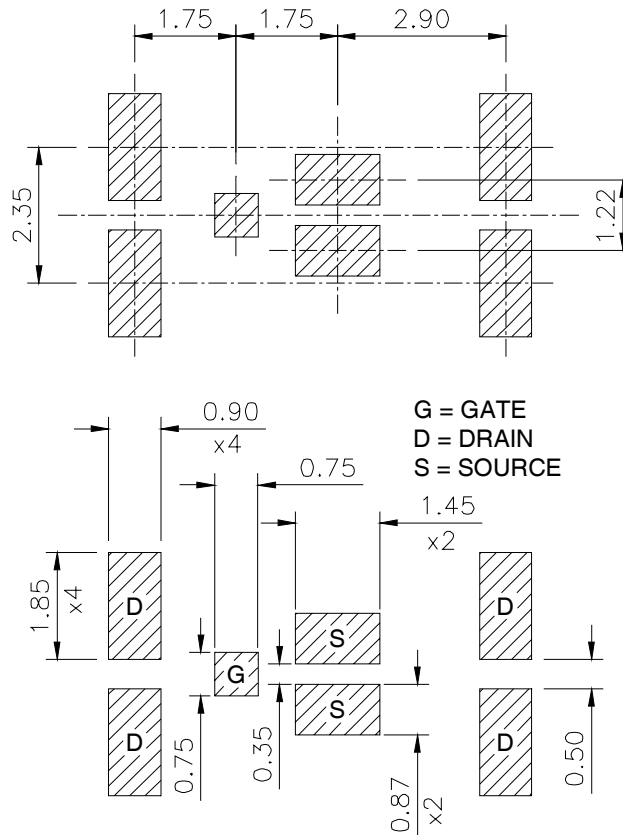

Fig 18. Diode Reverse Recovery Test Circuit for N-Channel HEXFET® Power MOSFETs

DirectFET™ Board Footprint, MX Outline (Medium Size Can, X-Designation).

Please see DirectFET application note AN-1035 for all details regarding the assembly of DirectFET. This includes all recommendations for stencil and substrate designs.



Note: For the most current drawing please refer to IR website at <http://www.irf.com/package/>

IRF6716MPbF

DirectFET™ Outline Dimension, MX Outline (Medium Size Can, X-Designation).

Please see DirectFET application note AN-1035 for all details regarding the assembly of DirectFET. This includes all recommendations for stencil and substrate designs.

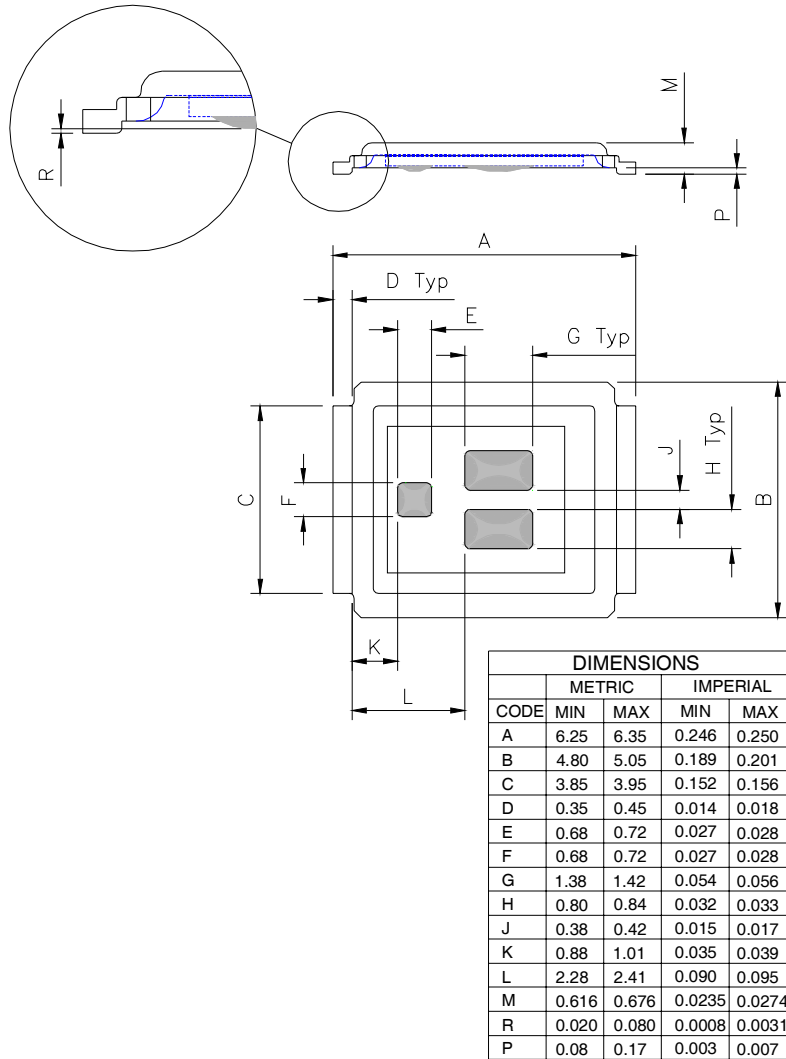

DirectFET™ Part Marking

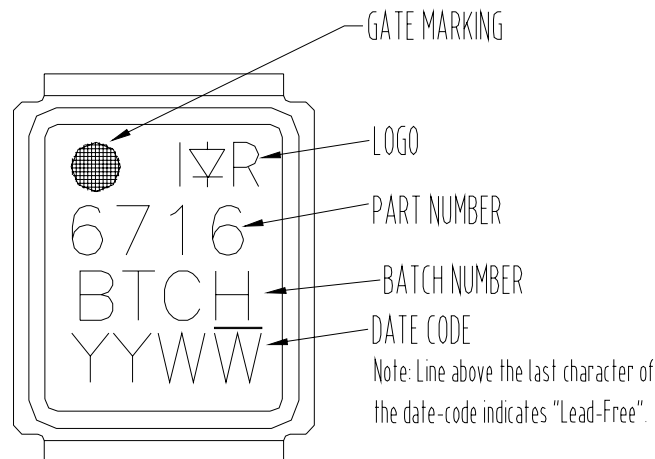

Note: For the most current drawing please refer to IR website at <http://www.irf.com/package/>

DirectFET™ Tape & Reel Dimension (Showing component orientation).

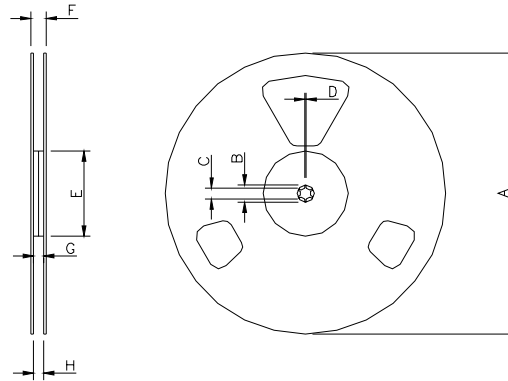

NOTE: Controlling dimensions in mm
 Std reel quantity is 4800 parts. (ordered as IRF6716). For 1000 parts on 7" reel, order IRF6716TR1

| REEL DIMENSIONS | | | | | | | | |
|-----------------|----------------------------|------|----------|-------|-----------------------|-------|----------|------|
| CODE | STANDARD OPTION (QTY 4800) | | | | TR1 OPTION (QTY 1000) | | | |
| | METRIC | | IMPERIAL | | METRIC | | IMPERIAL | |
| A | 330.0 | N.C | 12.992 | N.C | 177.77 | N.C | 6.9 | N.C |
| B | 20.2 | N.C | 0.795 | N.C | 19.06 | N.C | 0.75 | N.C |
| C | 12.8 | 13.2 | 0.504 | 0.520 | 13.5 | 12.8 | 0.53 | 0.50 |
| D | 1.5 | N.C | 0.059 | N.C | 1.5 | N.C | 0.059 | N.C |
| E | 100.0 | N.C | 3.937 | N.C | 58.72 | N.C | 2.31 | N.C |
| F | N.C | 18.4 | N.C | 0.724 | N.C | 13.50 | N.C | 0.53 |
| G | 12.4 | 14.4 | 0.488 | 0.567 | 11.9 | 12.01 | 0.47 | N.C |
| H | 11.9 | 15.4 | 0.469 | 0.606 | 11.9 | 12.01 | 0.47 | N.C |

LOADED TAPE FEED DIRECTION

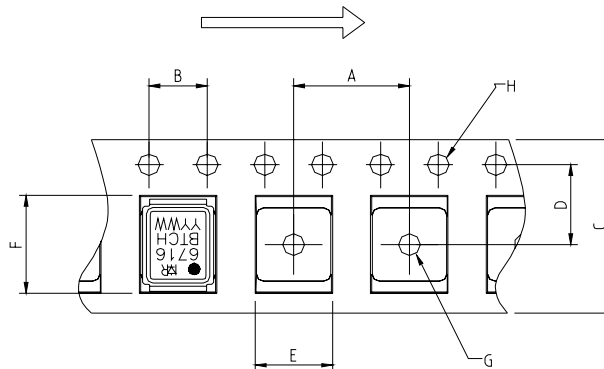

NOTE: CONTROLLING DIMENSIONS IN MM

| CODE | DIMENSIONS | | | |
|------|------------|-------|----------|-------|
| | METRIC | | IMPERIAL | |
| A | 7.90 | 8.10 | 0.311 | 0.319 |
| B | 3.90 | 4.10 | 0.154 | 0.161 |
| C | 11.90 | 12.30 | 0.469 | 0.484 |
| D | 5.45 | 5.55 | 0.215 | 0.219 |
| E | 5.10 | 5.30 | 0.201 | 0.209 |
| F | 6.50 | 6.70 | 0.256 | 0.264 |
| G | 1.50 | N.C | 0.059 | N.C |
| H | 1.50 | 1.60 | 0.059 | 0.063 |

Note: For the most current drawing please refer to IR website at <http://www.irf.com/package/>

Data and specifications subject to change without notice.
 This product has been designed and qualified for the Consumer market.
 Qualification Standards can be found on IR's Web site.

Mouser Electronics

Authorized Distributor

Click to View Pricing, Inventory, Delivery & Lifecycle Information:

[Infineon:](#)

[IRF6716MTRPBF](#)