

GENERAL DESCRIPTION

The XRP2525 and XRP2526 devices are respectively single and dual channel integrated high-side power distribution switches with independent enables and fault flags. A wide 1.8V to 5.5V input voltage range allows for operations from industry standard 1.8V, 3.3V and 5V power rails.

Optimized for USB V_{BUS} power distribution, the XRP2525 and XRP2526 are compliant with the latest USB 3.0 specification and can be used in any self or bus powered USB applications. The power-switch rise and fall times are controlled to minimize current surges during turn on/off.

The XRP2525 and XRP2526 are pin and function compatible to respectively Exar’s SP2525A and SP2526A.

Built-in over current, under voltage lockout (UVLO), reverse current and over temperature protections insure safe operations under abnormal operating conditions.

XRP2525 and XRP2526 are offered in a RoHS compliant “green”/halogen free 8-pin NSOIC package.

APPLICATIONS

- Self Powered USB 2.0 and 3.0 Hubs
- USB Compliant V_{BUS} Power Distribution
- Audio-Video Equipments
- Generic Power Switching

FEATURES

- **Single/Dual Channel Current Switch**
 - 900mA per channel capable
 - 1.15A Over-current Limit
 - 1.8V to 5.5V Input Voltage Range
- **USB 2.0/3.0 Compliant**
- **Active High or Low Individual Enable**
- **Individual Channel Fault Flag Indicator**
- **Under voltage Lockout, Reverse Current and Thermal Shutdown Protection**
- **RoHS Compliant, Green/Halogen Free 8-Pin NSOIC Package**

TYPICAL APPLICATION DIAGRAM

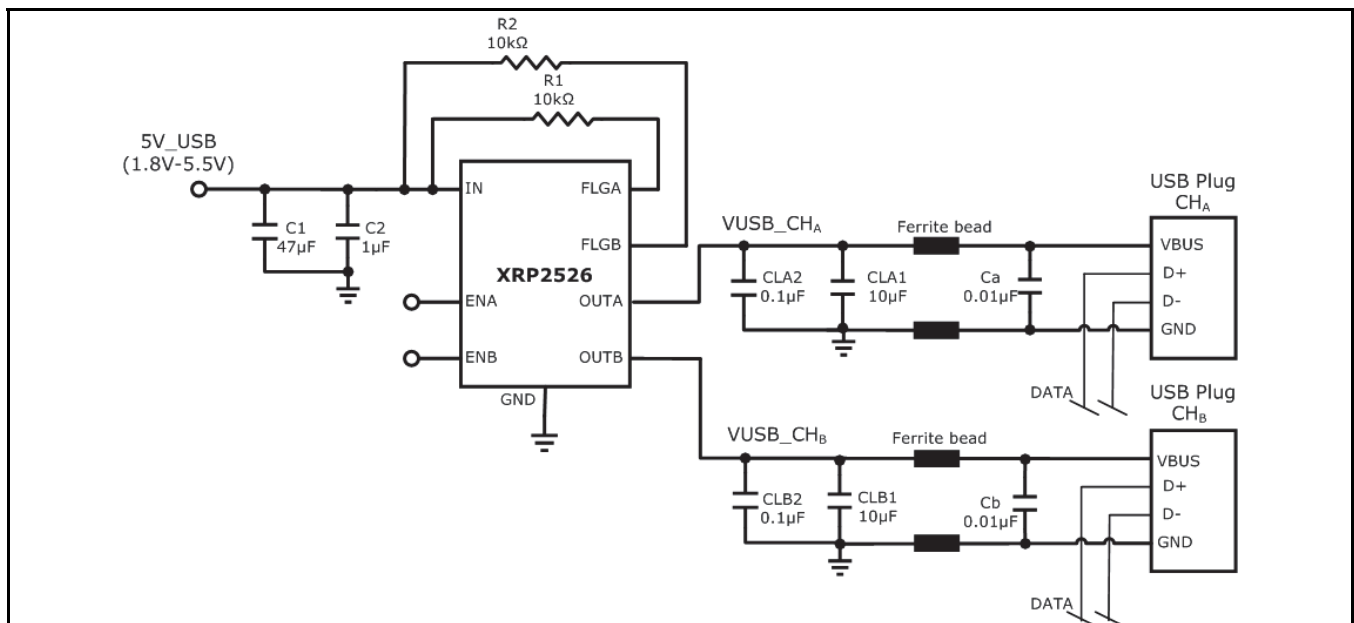

Fig. 1: XRP2526 Application Diagram



ABSOLUTE MAXIMUM RATINGS

These are stress ratings only and functional operation of the device at these ratings or any other above those indicated in the operation sections of the specifications below is not implied. Exposure to absolute maximum rating conditions for extended periods of time may affect reliability.

- V_{IN}..... -0.3V to 7.0V
- V_{EN}, V_{FLG} 7.0V
- Storage Temperature..... -65°C to 150°C
- Power Dissipation Internally Limited
- Lead Temperature (Soldering, 10 sec) 300°C
- ESD Rating (HBM - Human Body Model) 2kV
- ESD Rating (MM - Machine Model)200V

OPERATING RATINGS

- Input Voltage Range V_{IN}..... 1.75V to 5.5V
- Junction Temperature Range-40°C to 125°C
- Thermal Resistance θ_{JA} 128.4°C/W

ELECTRICAL SPECIFICATIONS

Specifications are for an Operating Junction Temperature of T_J = 25°C only; limits applying over the full Operating Junction Temperature range are denoted by a “•”. Minimum and Maximum limits are guaranteed through test, design, or statistical correlation. Typical values represent the most likely parametric norm at T_J = 25°C, and are provided for reference purposes only. Unless otherwise indicated, 1.8V to 5.5V, C_{IN} = 47µF//1µF, C_{OUT} = 10µF, T_J = -40°C to 125°C.

Parameter	Min.	Typ.	Max.	Units	Conditions
Input Supply Voltage	1.8		5.5	V	•
Input Quiescent Current		80	150	µA	• XRP2526 (Both Channels enabled) V _{IN} =5V, I _{OUT1} = I _{OUT2} =0mA
Input Quiescent Current		52	100	µA	• XRP2525 & XRP2526 (1 Channel enabled) V _{IN} =5V, I _{OUT1} =0mA
Input Shutdown Current			3	µA	• V _{IN} =5V, Channel(s) disabled
Maximum Output Current per channel	900			mA	• XRP2525 and XRP2526
Output Leakage Current			10	µA	V _{IN} =5V, V _{OUT} =0V, Each channel, Switch off
Reverse Leakage Current			10	µA	V _{IN} =0V, V _{OUT} =5V, Each channel, Switch off
Output MOSFET Resistance		80	140	mΩ	• I _{OUT} =0.3A, Each channel
Output turn-on delay		1000		µs	V _{IN} =5V, R _L =10Ω, C _{OUT} =1µF, each output
Output turn-on rise time		2000	4000	µs	V _{IN} =5V, R _L =10Ω, C _{OUT} =1µF, each output
Output turn-off delay		10	20	µs	V _{IN} =5V, R _L =10Ω, C _{OUT} =1µF, each output
Output turn-off fall time		22	50	µs	V _{IN} =5V, R _L =10Ω, C _{OUT} =1µF, each output
Current limit threshold	0.90	1.15	1.40	A	• V _{IN} - V _{OUT} =0.3V, Internally set
Short Circuit Current Limit		0.66xI _{LIM}		A	V _{OUT} =0V
Output Voltage Short Circuit Detect Threshold		925		mV	Operates in short circuit current limit mode when output voltage is below threshold.
Safe Operating Area (SOA) Current Limit		3		A	
Over temperature shutdown threshold		135		°C	Temperature rising
Over temperature shutdown threshold hysteresis		10		°C	Temperature decreasing
Under-voltage lockout threshold	1.55	1.68	1.75	V	V _{IN} rising or falling
Under-voltage lockout hysteresis		50		mV	
FLG output logic low voltage		100	250	mV	I _{FLG} =10mA, V _{IN} =5.5V
FLG output high leakage			1	µA	
FLG blanking time		10		ms	
EN input logic high voltage	1.5			V	•
EN input logic low voltage			0.5	V	•
EN input leakage current	-1	0	1	µA	V _{EN} =0V or V _{EN} =5.5V

BLOCK DIAGRAM

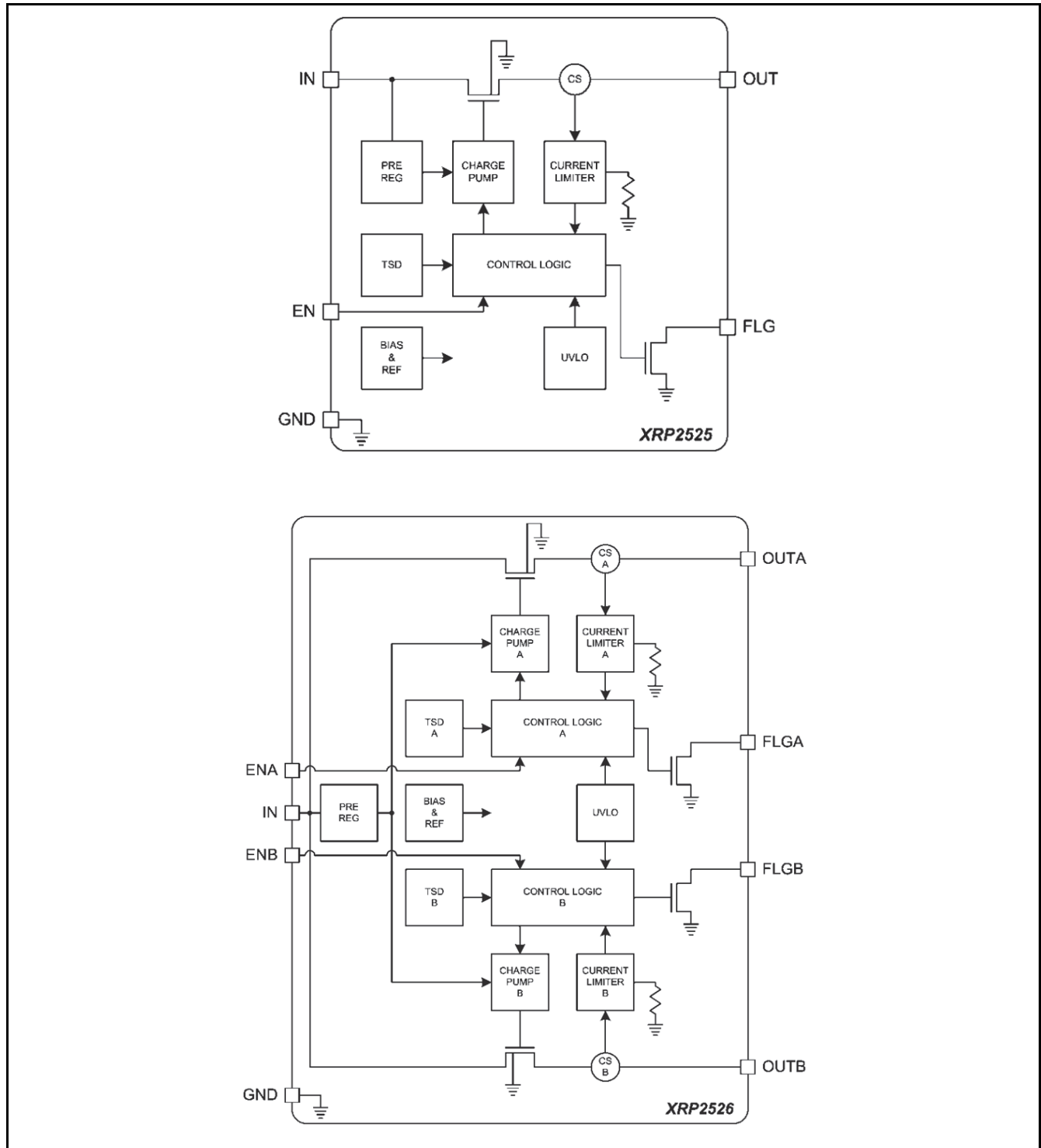

Fig. 2: XRP2525 and XRP2526 Block Diagrams

PIN ASSIGNMENT

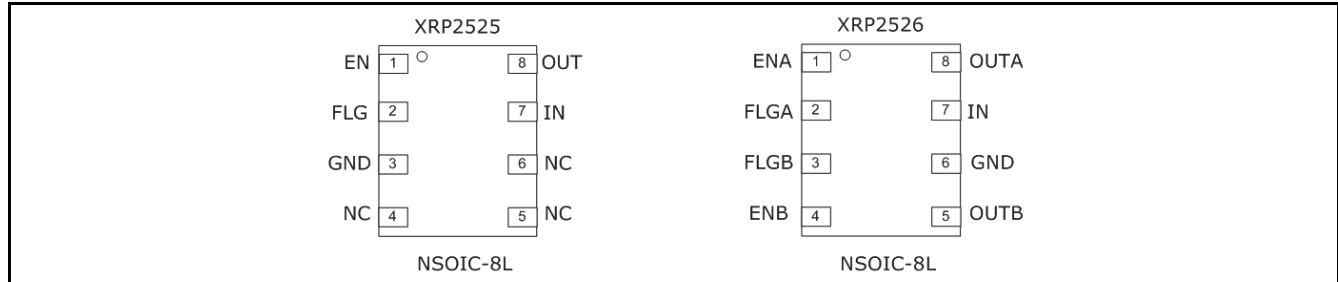

Fig. 3: XRP2525 - XRP2526 Pin Assignment

PIN DESCRIPTION – XRP2525

Name	Pin Number	Description
EN	1	Channel Enable Input Active High for XRP2525-1 and Active Low for XRP2525-2
FLG	2	Error Flag Signal Active low open drain output. Active on over-current, over-temperature or UVLO conditions.
GND	3	Ground Signal
NC	4,5,6	No Connect
IN	7	Voltage Input Pin
OUT	8	Voltage Output Pin

PIN DESCRIPTION – XRP2526

Name	Pin Number	Description
EN _x	1,4	Channel Enable Input Active High for XRP2526-1 and Active Low for XRP2526-2
FLG _x	2,3	Error Flag Signal Active low open drain output. Active on over-current, over-temperature or UVLO conditions.
GND	6	Ground Signal
IN	7	Voltage Input Pin
OUT _x	5,8	Voltage Output Pin

ORDERING INFORMATION

Part Number	Temperature Range	Marking	Package	Packing Quantity	Note 1	Note 2
XRP2525ID-1-F	-40°C ≤ T _A ≤ +85°C	2525ID 1 YYWW X	NSOIC8	Bulk	Lead Free and Halogen Free	Single Channel Active high
XRP2525IDTR-1-F				2.5K/Tape & Reel		
XRP2525ID-2-F	-40°C ≤ T _A ≤ +85°C	2525ID 2 YYWW X	NSOIC8	Bulk	Lead Free and Halogen Free	Single Channel Active low
XRP2525IDTR-2-F				2.5K/Tape & Reel		
XRP2526ID-1-F	-40°C ≤ T _A ≤ +85°C	2526ID 1 YYWW X	NSOIC8	Bulk	Lead Free and Halogen Free	Dual Channel Active high
XRP2526IDTR-1-F				2.5K/Tape & Reel		
XRP2526ID-2-F	-40°C ≤ T _A ≤ +85°C	2526ID 2 YYWW X	NSOIC8	Bulk	Lead Free and Halogen Free	Dual Channel Active low
XRP2526IDTR-2-F				2.5K/Tape & Reel		
XRP2525EVB	XRP2525 Evaluation Board					
XRP2526EVB	XRP2526 Evaluation Board					

“YY” = Year – “WW” = Work Week – “X” = Lot Number; when applicable.

TYPICAL PERFORMANCE CHARACTERISTICS

All data taken at $V_{IN} = 5V$, $C_{IN} = 47\mu F // 1\mu F$, $C_{OUT} = 10\mu F$, $T_J = T_A = 25^\circ C$, unless otherwise specified - Schematic and BOM from Application Information section of this datasheet.

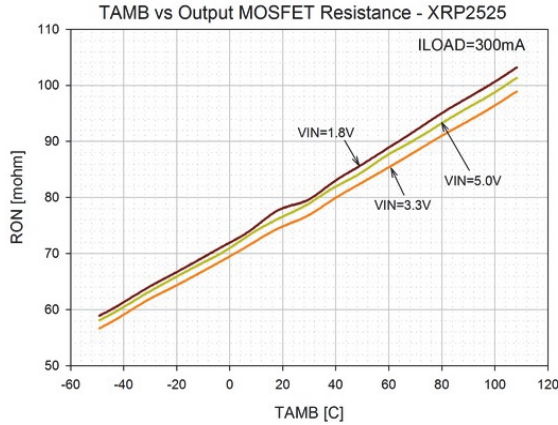

Fig. 4: Output On-Resistance vs. Temperature (XRP2525)

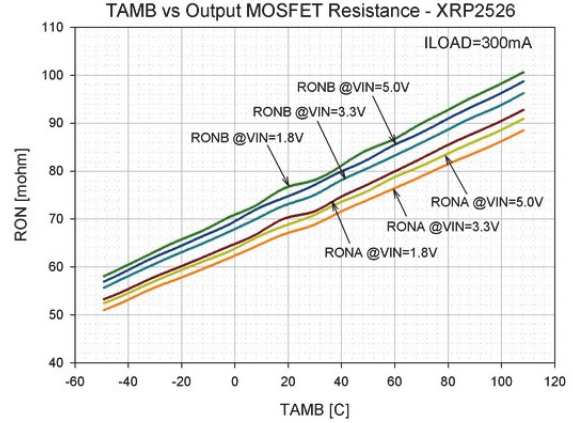

Fig. 5: Output On-Resistance vs. Temperature (XRP2526)

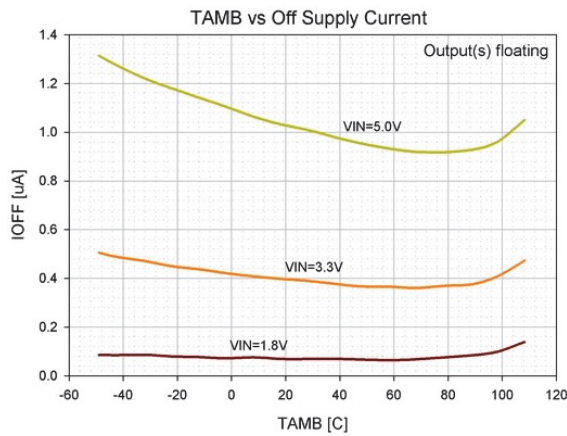

Fig. 6: Off Supply Current vs. Temperature

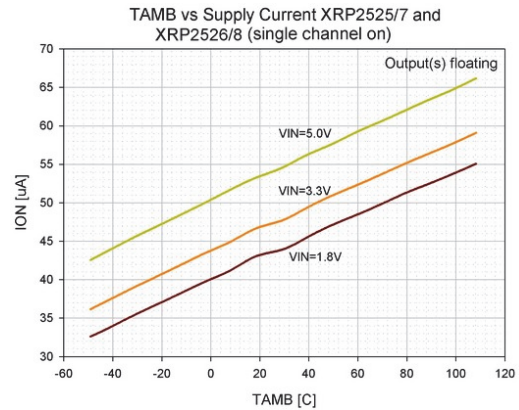

Fig. 7: Quiescent Current vs. Temperature XRP2525 and XRP2526 (1-channel on)

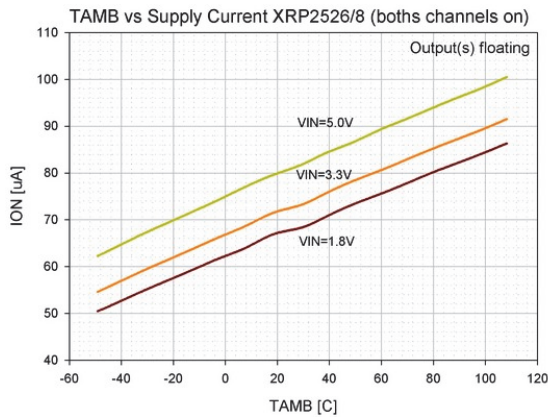

Fig. 8: Quiescent Current vs. Temperature XRP2526 (2-channels on)

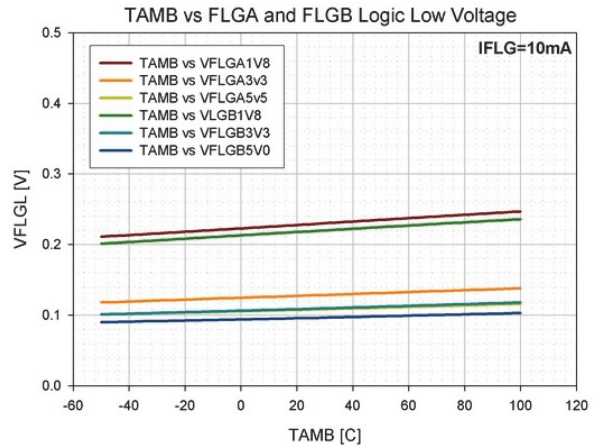

Fig. 9: FLG Logic Low Voltage vs. Temperature



XRP2525 - XRP2526

Single/Dual Channel USB 3.0 Power Distribution Switch

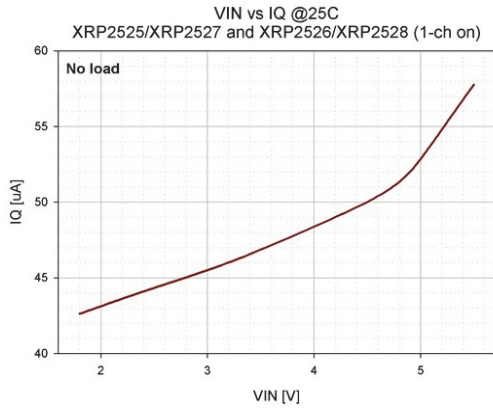

Fig. 10: Quiescent Current vs. Input Voltage XRP2525 and XRP2526 (1-channel on)

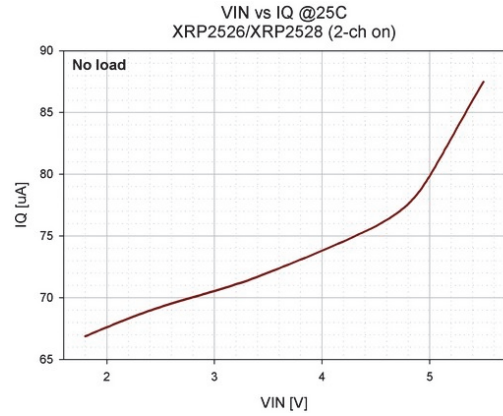

Fig. 11: Quiescent Current vs. Input Voltage XRP2526 (2-channels on)

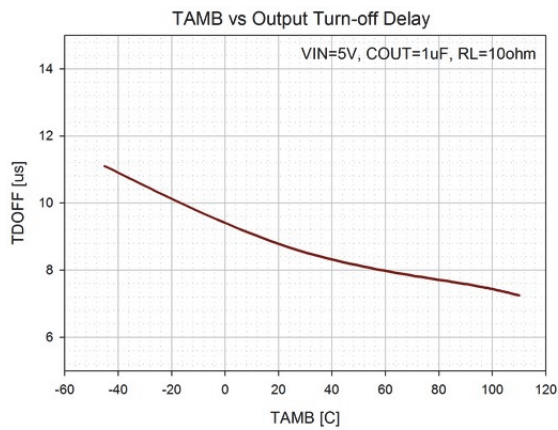

Fig. 12: Output Turn-Off Delay vs. Temperature

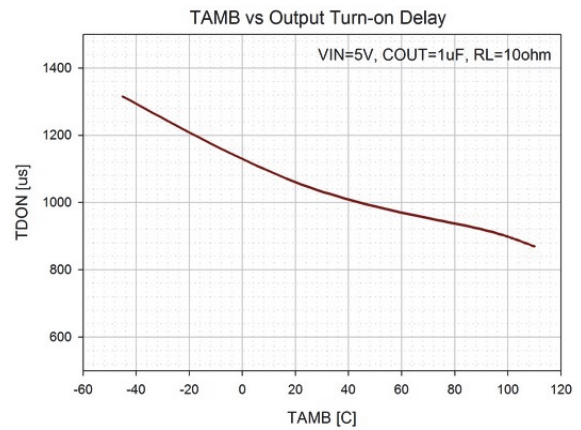

Fig. 13: Output Turn-on Delay vs. Temperature

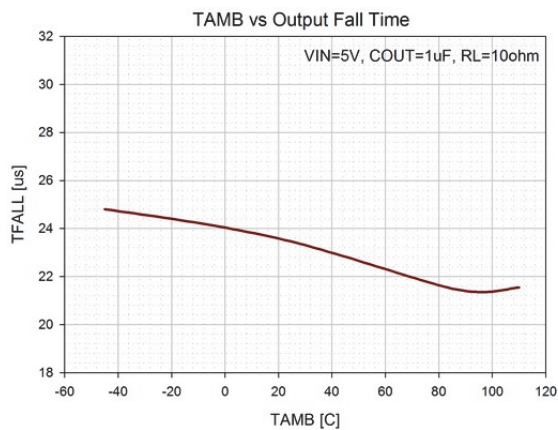

Fig. 14: Output Fall Time vs. Temperature

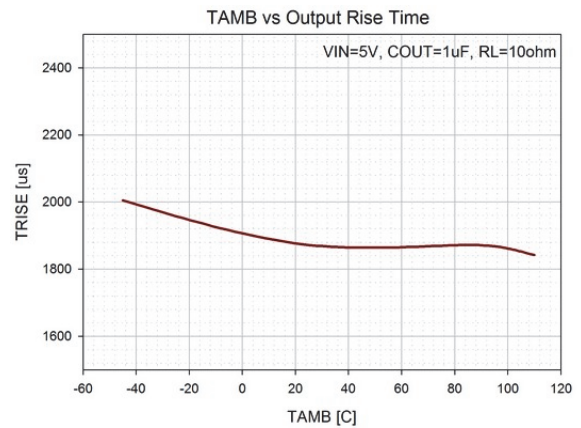

Fig. 15: Output Rise Time vs. Temperature

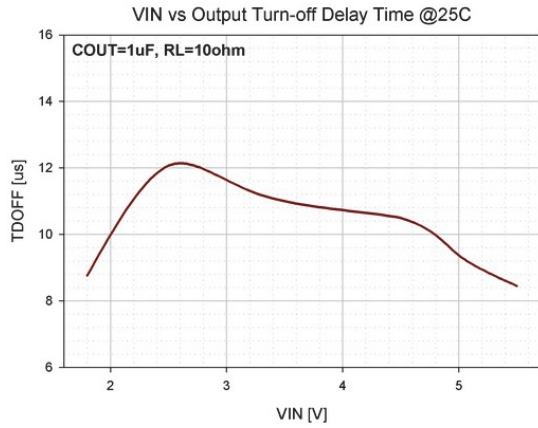

Fig. 16: Output Turn-Off Delay Time vs. Input Voltage

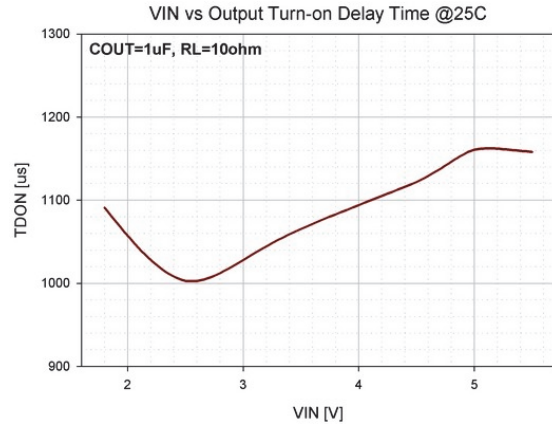

Fig. 17: Output Turn-On Delay Time vs. Input Voltage

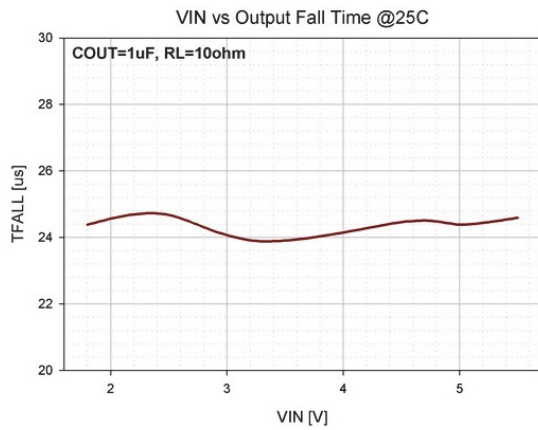

Fig. 18: Output Fall Time vs. Input Voltage

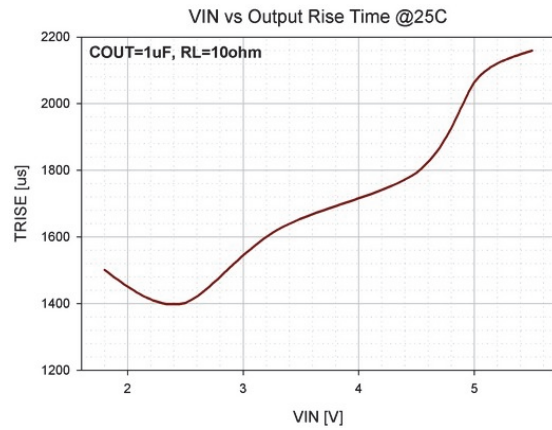

Fig. 19: Output Rise Time vs. Input Voltage

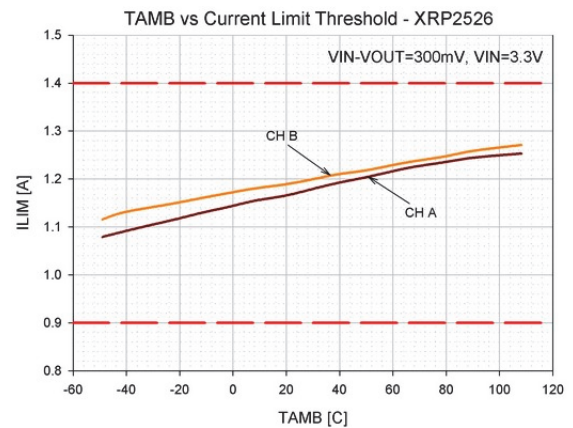
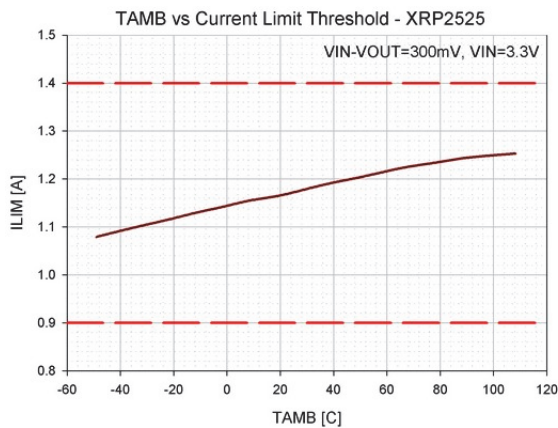

Fig. 20: Current Limit Threshold vs. Temperature (XRP2525) Fig. 21: Current Limit Threshold vs. Temperature (XRP2526)

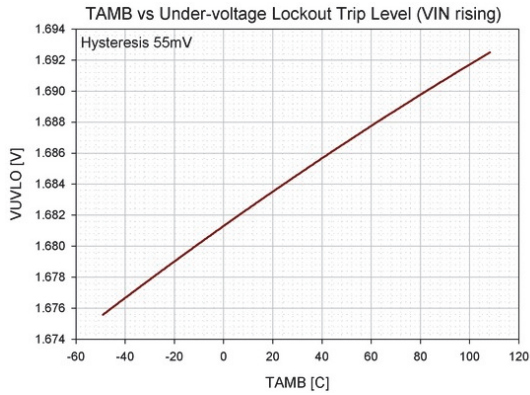

Fig. 22: Under-voltage lockout trip level vs. Temperature (VIN Rising)

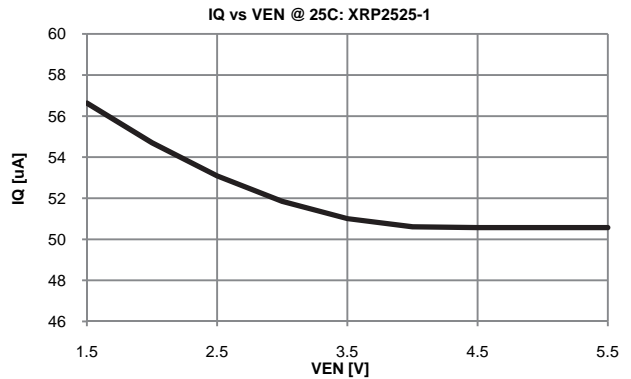

Fig. 23: Quiescent Current vs. Enable pin Voltage XRP2525-1

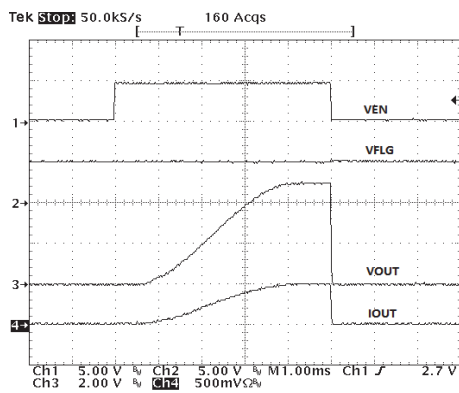

Fig. 24: Turn-On, Turn-Off Characteristics (XRP2526-1) COUT = 1uF, Load = 10Ω

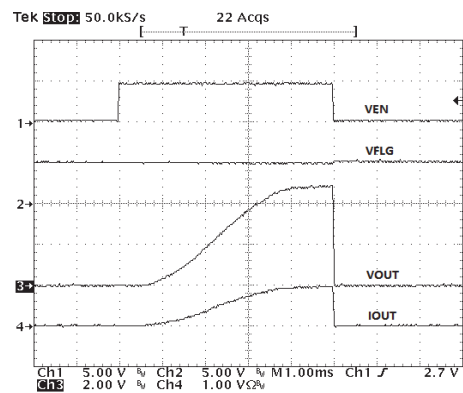

Fig. 25: Turn-On, Turn-Off Characteristics (XRP2526-1) COUT = 1uF, Load = 5.1Ω

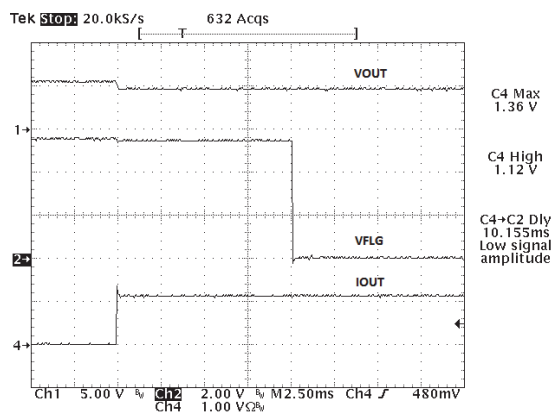

Fig. 26: Current Limit Operation (XRP2525-1): VIN=5.5V, Load = 3.9Ω

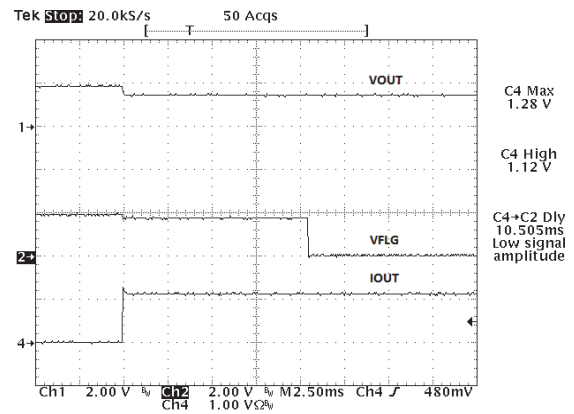

Fig. 27: Current Limit Operation (XRP2526-1): VIN=1.8V, Load = 1.5Ω

THEORY OF OPERATION

The XRP2525 and XRP2526 devices are respectively single and dual channel integrated high-side power distribution switches that can be used in any self or bus powered USB applications. They are compliant with the latest USB 3.0 specifications. The reverse current protection feature prevents current to flow from OUT to IN when the device is disabled.

INPUT & OUTPUT

Placing bulk capacitances of at least 47 μ F and 10 μ F at the input and output pins respectively reduces power supply transients under heavy current load conditions.

It is important to place a 1 μ F ceramic bypass capacitor from IN to GND as close as possible to the device in order to control supply transients.

Furthermore, bypassing the output pin with a 0.1 μ F to 1 μ F ceramic capacitor improves the device response to short-circuit transients.

ERROR FLAG

The error flag signal (FLG_x output pin) is an open-drain output and is pulled low (active low) upon detection of the following conditions:

- Over-current condition
- Over-temperature condition
- Under voltage lockout condition

Over-temperature and under voltage lockout conditions are flagged immediately while the over – current condition is reported only if this condition persists continuously for longer than the blanking time of 10ms. The blanking time prevents erroneous reporting of current faults due to brief output current spikes.

Once activated, the error flag signal remains low until all fault conditions have been removed and is independent for each individual channel.

CURRENT LIMIT

The current limit threshold is preset internally. It protects the output MOSFET switches from

damages resulting from undesirable short circuit conditions or excess inrush current, which is often encountered during hot plug-in. The low limit of the current limit threshold of the XRP2525 and XRP2526 allows a minimum current of 0.9A through the MOSFET switches.

When an overcurrent condition is detected, the output current is limited to a constant current limit threshold value and output voltage is reduced accordingly. Triggering the current limit function is signaled by the Error Flag after 10ms of blanking time period.

UNDER-VOLTAGE LOCKOUT

Under-voltage lockout function (UVLO) keeps the internal power switch from being turned on until the power supply has reached at least 1.68V, even if the switch is enabled. Upon detection of an input voltage below approximately 1.68V, the power switch is turned off while a fault condition is reported by the error flag signal.

THERMAL PROTECTION

Internal thermal sensing circuitry monitors the operating temperature of the device for each channel independently. Upon detection of a temperature in excess of 135°C, the power switch for the given channel is disabled preventing any damages to the device while a fault condition is reported by the error flag signal. A built-in 10°C hysteresis allows the device to cool down to 125°C before resuming normal operations on the faulty channel at which point the error flag signal is cleared.

TEST CIRCUIT

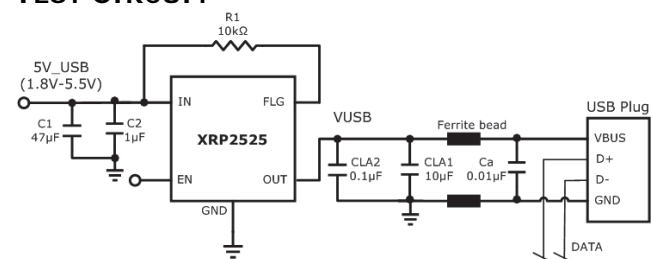



XRP2525 - XRP2526

Single/Dual Channel USB 3.0 Power Distribution Switch

PACKAGE SPECIFICATION

8-PIN NSOIC

Top View

Side View

Front View

8 Pin SOICN		JEDEC MS-012		Variation AA		
SYMBOLS	DIMENSIONS IN MM (Control Unit)			DIMENSIONS IN INCH (Reference Unit)		
	MIN	NOM	MAX	MIN	NOM	MAX
A	1.35	—	1.75	0.053	—	0.069
A1	0.10	—	0.25	0.004	—	0.010
A2	1.25	—	1.65	0.049	—	0.065
b	0.31	—	0.51	0.012	—	0.020
c	0.17	—	0.25	0.007	—	0.010
E	6.00 BSC			0.236 BSC		
E1	3.90 BSC			0.154 BSC		
e	1.27 BSC			0.050 BSC		
h	0.25	—	0.50	0.010	—	0.020
L	0.40	—	1.27	0.016	—	0.050
L1	1.04 REF			0.041 REF		
L2	0.25 BSC			0.010 BSC		
R	0.07	—	—	0.003	—	—
R1	0.07	—	—	0.003	—	—
θ	0°	—	8°	0°	—	8°
θ1	5°	—	15°	5°	—	15°
θ2	0°	—	—	0°	—	—
D	4.90 BSC			0.193 BSC		
N	8			8		

REVISION HISTORY			
REV.	DESCRIPTION	DATE	APP'D
A	DRAWING ORIGINATOR	08/16/05	JL
B	DRAWING FORMAT MODIFICATION	07/19/06	JL
C	CHANGE DRAWING LOGO AND COMPANY NAME	11/16/07	JL

By: JL Date: 11/16/07

Revision: C Sheet: 1 OF 1

Packaging Approval: EXAR CORPORATION

8 PIN SOICN PACKAGE OUTLINE

Drawing No: 8-PIN SOICN



REVISION HISTORY

Revision	Date	Description
1.0.0	05/13/2011	Initial release of datasheet
1.1.0	07/14/2011	Corrections of typographical errors

FOR FURTHER ASSISTANCE

Email: customersupport@exar.com
Exar Technical Documentation: <http://www.exar.com/TechDoc/default.aspx?>

EXAR CORPORATION

HEADQUARTERS AND SALES OFFICES

48720 Kato Road
Fremont, CA 94538 – USA
Tel.: +1 (510) 668-7000
Fax: +1 (510) 668-7030
www.exar.com



NOTICE

EXAR Corporation reserves the right to make changes to the products contained in this publication in order to improve design, performance or reliability. EXAR Corporation assumes no responsibility for the use of any circuits described herein, conveys no license under any patent or other right, and makes no representation that the circuits are free of patent infringement. Charts and schedules contained here in are only for illustration purposes and may vary depending upon a user's specific application. While the information in this publication has been carefully checked; no responsibility, however, is assumed for inaccuracies.

EXAR Corporation does not recommend the use of any of its products in life support applications where the failure or malfunction of the product can reasonably be expected to cause failure of the life support system or to significantly affect its safety or effectiveness. Products are not authorized for use in such applications unless EXAR Corporation receives, in writing, assurances to its satisfaction that: (a) the risk of injury or damage has been minimized; (b) the user assumes all such risks; (c) potential liability of EXAR Corporation is adequately protected under the circumstances.

Reproduction, in part or whole, without the prior written consent of EXAR Corporation is prohibited.

Mouser Electronics

Authorized Distributor

Click to View Pricing, Inventory, Delivery & Lifecycle Information:

[MaxLinear:](#)

[XRP2525EVB](#) [XRP2525ID-1-F](#) [XRP2525ID-2-F](#) [XRP2525IDTR-1-F](#) [XRP2525IDTR-2-F](#) [XRP2526EVB](#) [XRP2526ID-1-F](#) [XRP2526ID-2-F](#) [XRP2526IDTR-2-F](#)