

Ultrafast recovery diode

Datasheet – production data

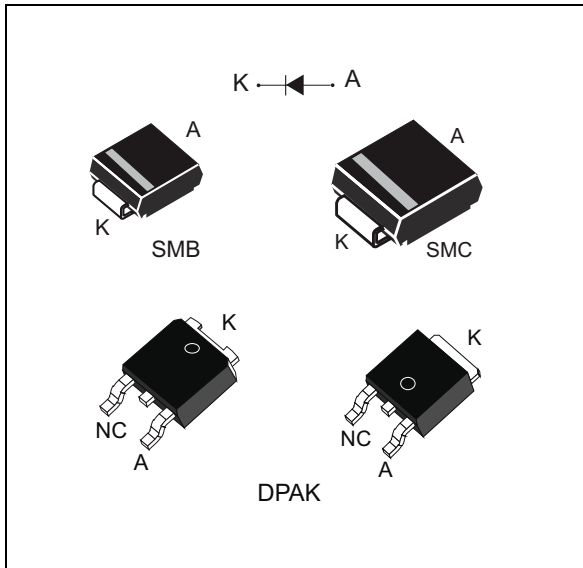

Description

The STTH4R02 uses ST's new 200 V planar Pt doping technology, and it is specially suited for switching mode base drive and transistor circuits.

Packaged in DPAK, SMB and SMC, this device is intended for use in low voltage, high frequency inverters, freewheeling and polarity protection.

Table 1. Device summary

Symbol	Value
$I_{F(AV)}$	4 A
V_{RRM}	200 V
V_F (typ)	0.76 V
T_j (max)	175 °C
t_{rr} (typ)	16 ns

Features

- Negligible switching losses
- High junction temperature
- Very low conduction losses
- Low forward and reverse recovery times
- ECOPACK[®]2 compliant component for DPAK on demand

1 Characteristics

Table 2. Absolute ratings (limiting values at 25 °C, unless otherwise specified)

Symbol	Parameter		Value	Unit
V_{RRM}	Repetitive peak reverse voltage		200	V
$I_{F(RMS)}$	Forward rms current	DPAK	10	A
		SMB / SMC	70	
$I_{F(AV)}$	Average forward current, $\delta = 0.5$, square wave	DPAK	4	A
		SMB / SMC		
I_{FSM}	Surge non repetitive forward current	$t_p = 10$ ms sinusoidal	70	A
T_{stg}	Storage temperature range		-65 to +175	°C
T_j	Maximum operating junction temperature		175	°C

Table 3. Thermal parameters

Symbol	Parameter		Max. value	Unit
$R_{th(j-c)}$	Junction to case	DPAK	3.5	°C/W
$R_{th(j-l)}$	Junction to lead	SMB / SMC	20	

Table 4. Static electrical characteristics

Symbol	Parameter	Test conditions		Min.	Typ.	Max.	Unit
$I_R^{(1)}$	Reverse leakage current	$T_j = 25$ °C	$V_R = V_{RRM}$	-		3	μA
		$T_j = 125$ °C		-	2	20	
$V_F^{(2)}$	Forward voltage drop	$T_j = 25$ °C	$I_F = 12$ A	-	1.15	1.25	V
			$I_F = 4$ A	-	0.95	1.05	
		$T_j = 150$ °C	-	0.76	0.83		

1. Pulse test: $t_p = 5$ ms, $\delta < 2\%$
2. Pulse test: $t_p = 380$ μs , $\delta < 2\%$

To evaluate the conduction losses, use the following equation:

$$P = 0.67 \times I_{F(AV)} + 0.04 \times I_{F(RMS)}^2$$

Table 5. Dynamic electrical characteristics

Symbol	Parameter	Tests conditions		Min.	Typ.	Max.	Unit
t_{rr}	Reverse recovery time	$T_j = 25\text{ °C}$	$I_F = 1\text{ A}$ $di_F/dt = -50\text{ A}/\mu\text{s}$ $V_R = 30\text{ V}$	-	24	30	ns
			$I_F = 1\text{ A}$ $di_F/dt = -100\text{ A}/\mu\text{s}$ $V_R = 30\text{ V}$	-	16	20	
I_{RM}	Reverse recovery current	$T_j = 125\text{ °C}$	$I_F = 4\text{ A}$ $di_F/dt = -200\text{ A}/\mu\text{s}$ $V_R = 160\text{ V}$	-	4.4	5.5	A
t_{fr}	Forward recovery time	$T_j = 25\text{ °C}$	$I_F = 4\text{ A}$ $di_F/dt = 50\text{ A}/\mu\text{s}$ $V_{FR} = 1.1 \times V_{Fmax}$	-	80		ns
V_{FP}	Forward recovery voltage		$I_F = 4\text{ A}$ $di_F/dt = 50\text{ A}/\mu\text{s}$	-	1.6		V

Figure 1. Peak current versus duty cycle

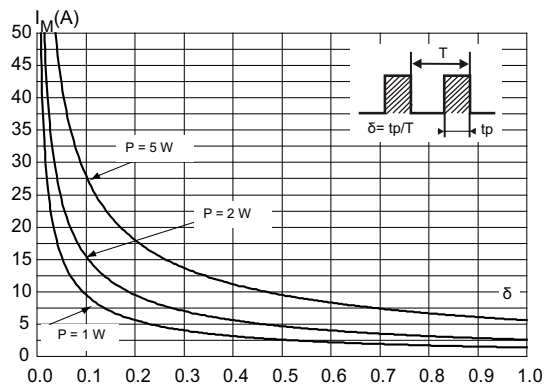

Figure 2. Forward voltage drop versus forward current (typical values)

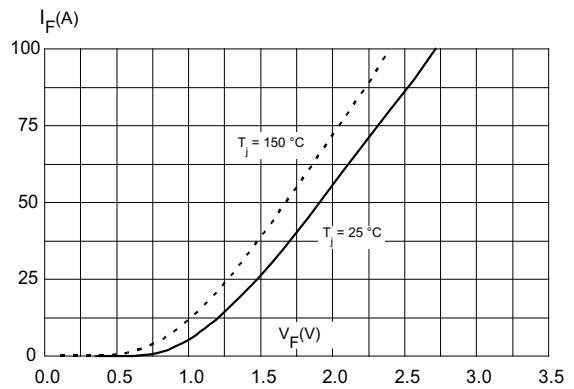

Figure 3. Forward voltage drop versus forward current (maximum values)

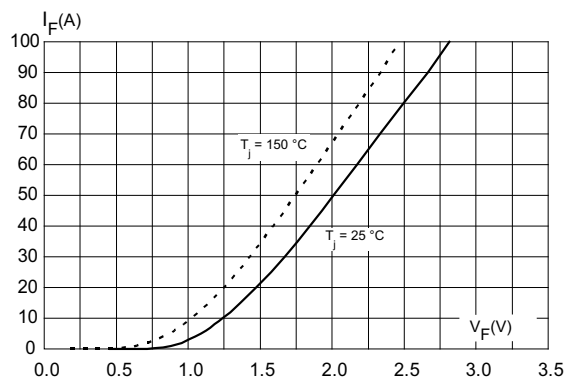

Figure 4. Relative variation of thermal impedance, junction to case, versus pulse duration

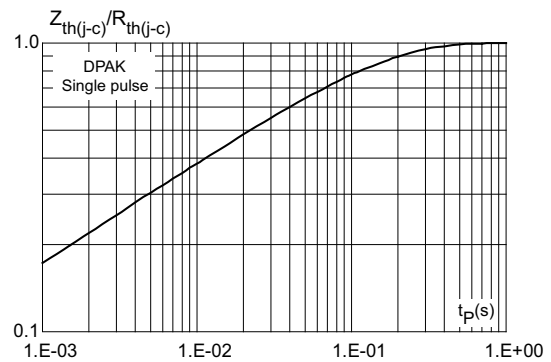

Figure 5. Relative variation of thermal impedance, junction to ambient, versus pulse duration (SMB)

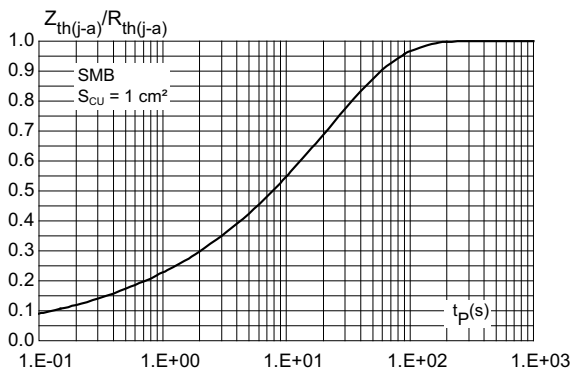

Figure 6. Relative variation of thermal impedance, junction to ambient, versus pulse duration (SMC)

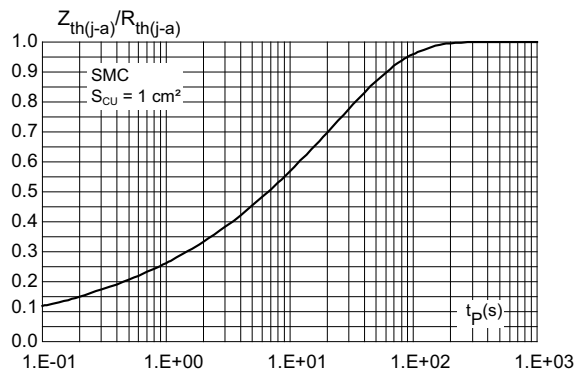

Figure 7. Junction capacitance versus reverse applied voltage (typical values)

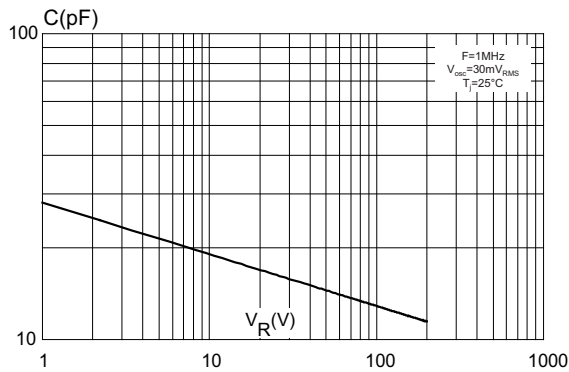

Figure 8. Reverse recovery charges versus di_F/dt (typical values)

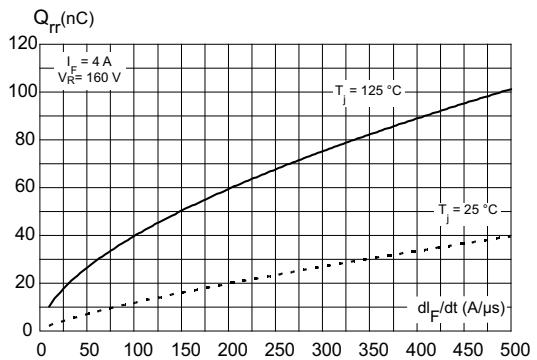

Figure 9. Reverse recovery time versus di_F/dt (typical values)

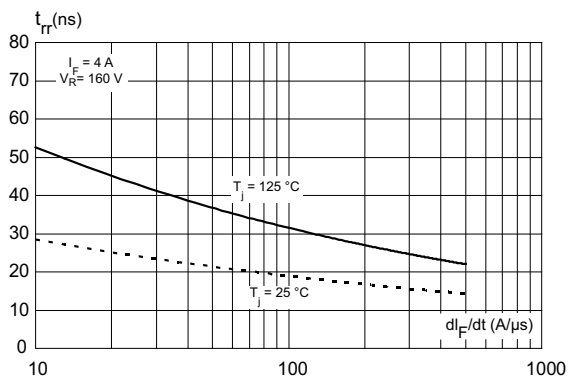

Figure 10. Peak reverse recovery current versus di_F/dt (typical values)

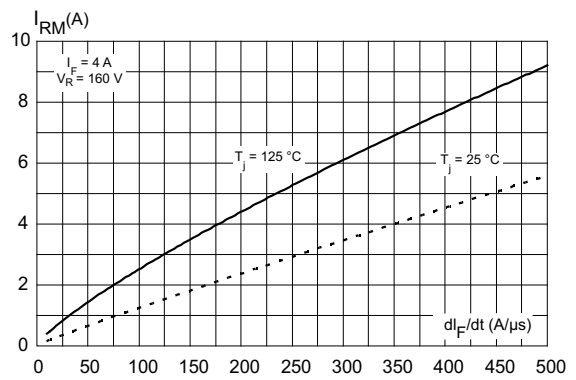

Figure 11. Dynamic parameters versus junction temperature (reference: $T_j = 125^\circ\text{C}$)

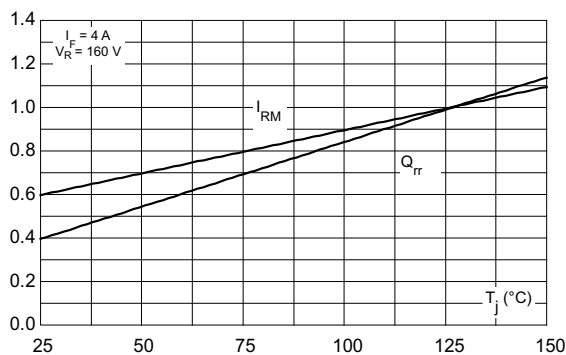

Figure 12. Thermal resistance, junction to ambient, versus copper surface under each lead

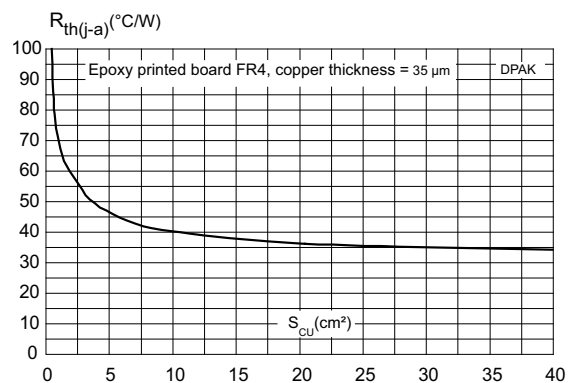

Figure 13. Thermal resistance, junction to ambient, versus copper surface under each lead

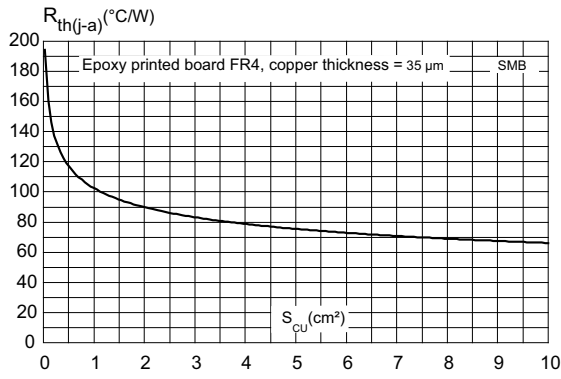
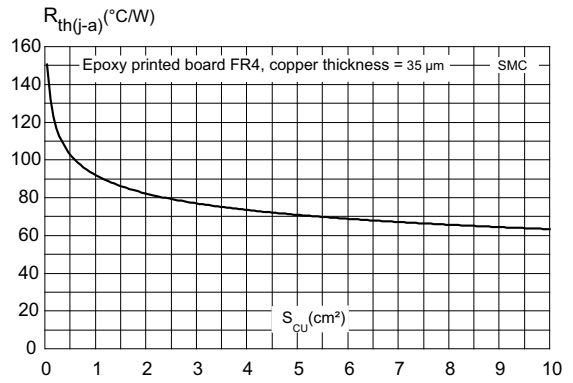

Figure 14. Thermal resistance, junction to ambient, versus copper surface under tab



2 Package information

- Epoxy meets UL94,V0
- Cooling method: by conduction (C)
- Band indicates cathode

In order to meet environmental requirements, ST offers these devices in different grades of ECOPACK® packages, depending on their level of environmental compliance. ECOPACK® specifications, grade definitions and product status are available at: www.st.com. ECOPACK® is an ST trademark.

2.1 DPAK package information

Figure 15. DPAK package outline

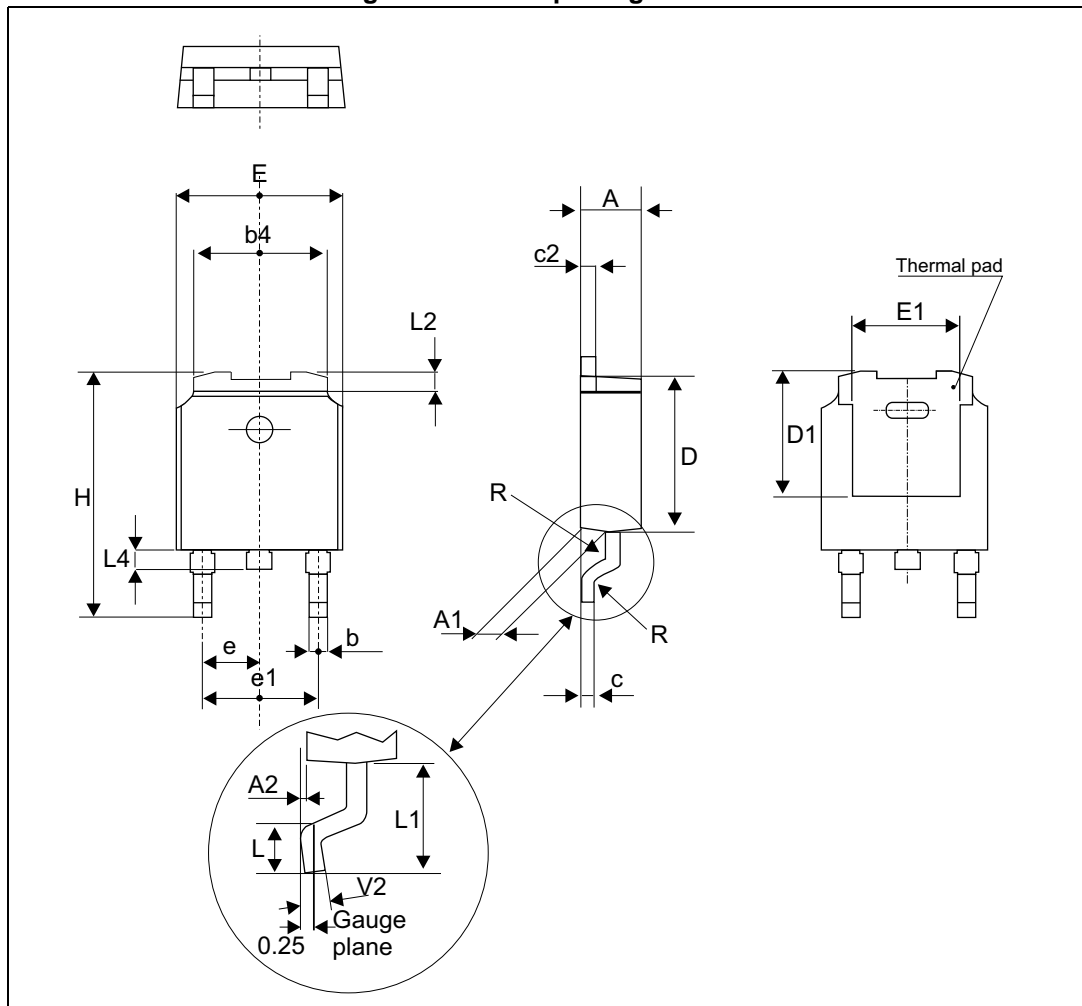

Note: This package drawing may slightly differ from the physical package. However, all the specified dimensions are guaranteed.

Table 6. DPAK package mechanical data

Ref.	Dimensions					
	Millimeters			Inches		
	Min.	Typ.	Max.	Min.	Typ.	Max.
A	2.18		2.40	0.085		0.094
A1	0.90		1.10	0.035		0.043
A2	0.03		0.23	0.001		0.009
b	0.64		0.90	0.025		0.035
b4	4.95		5.46	0.194		0.214
c	0.46		0.61	0.018		0.024
c2	0.46		0.60	0.018		0.023
D	5.97		6.22	0.235		0.244
D1	4.95		5.60	0.194		0.220
E	6.35		6.73	0.250		0.264
E1	4.32		5.50	0.170		0.216
e		2.28			0.090	
e1	4.40		4.70	0.173		0.185
H	9.35		10.40	0.368		0.409
L	1.00		1.78	0.039		0.070
L2			1.27			0.050
L4	0.60		1.02	0.023		0.040
V2	-8°		+8°	-8°		8°

Figure 16. DPAK footprint dimensions (in mm)

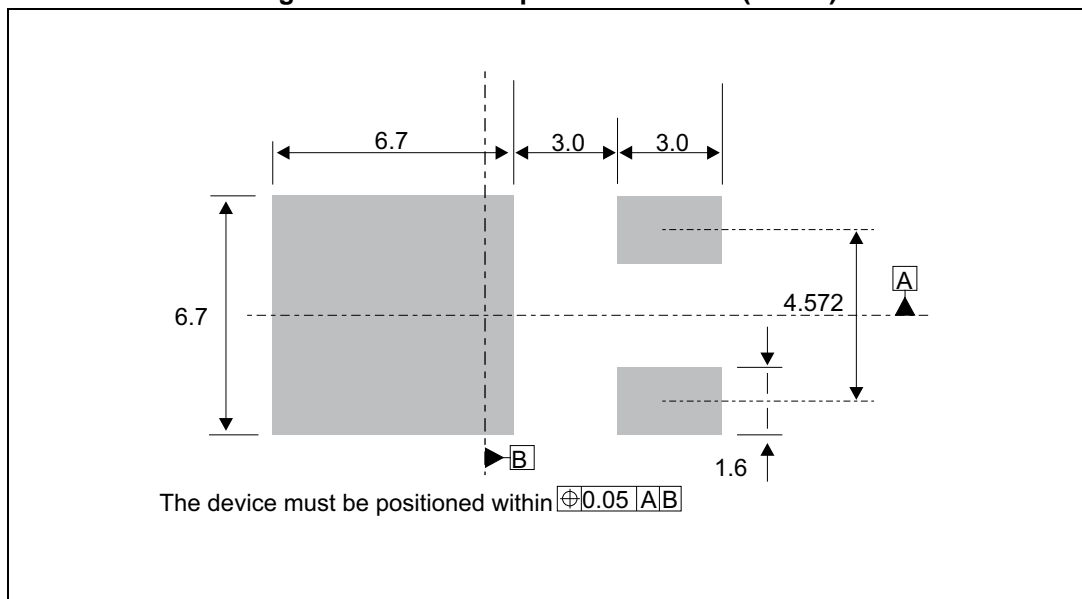

2.2 SMB package information

Figure 17. SMB package outline

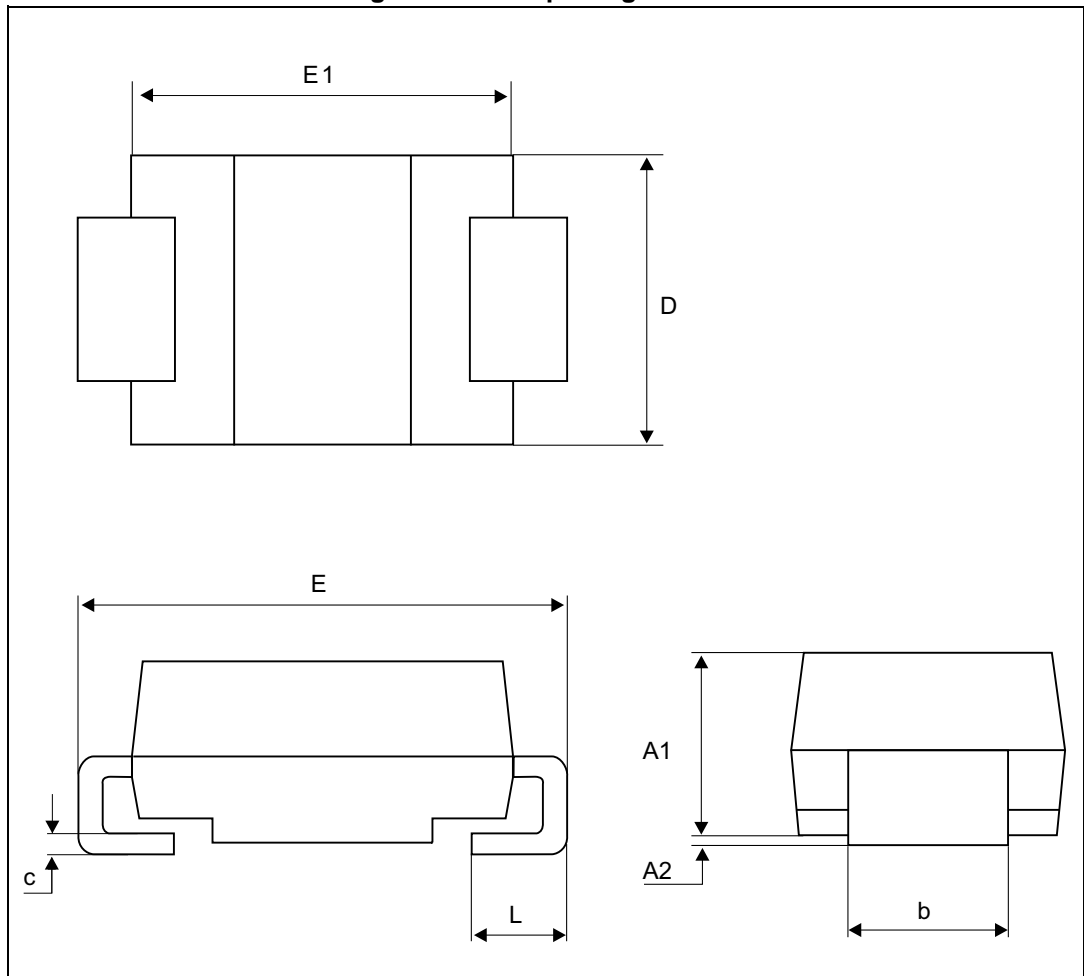
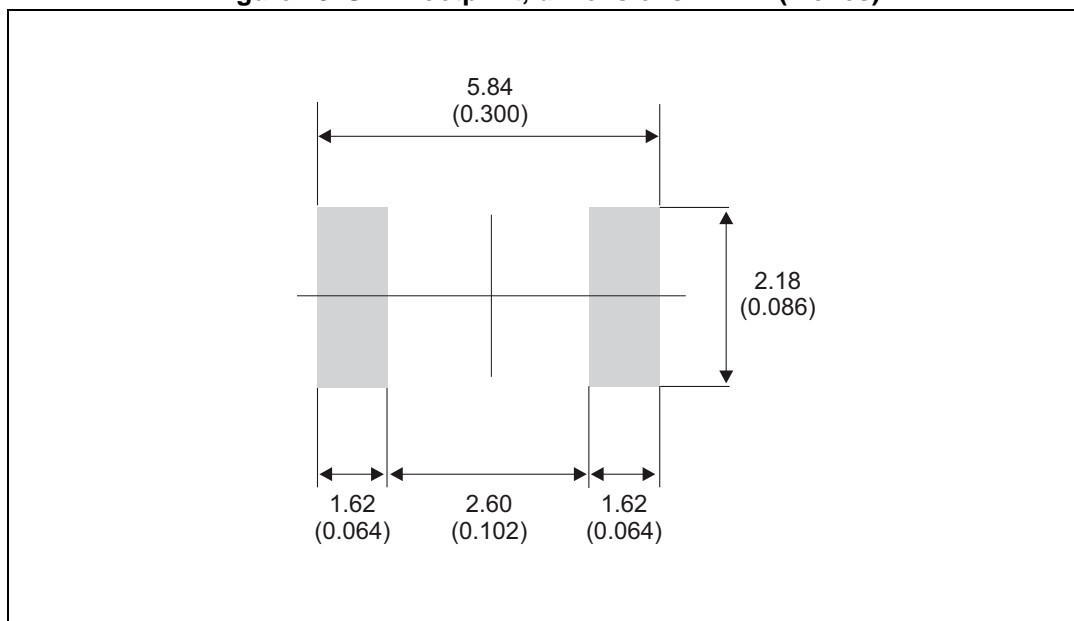

Table 7. SMB package mechanical data

Ref.	Dimensions			
	Millimeters		Inches	
	Min.	Max.	Min.	Max.
A1	1.90	2.45	0.075	0.096
A2	0.05	0.20	0.002	0.008
b	1.95	2.20	0.077	0.087
c	0.15	0.40	0.006	0.016
D	3.30	3.95	0.130	0.156
E	5.10	5.60	0.201	0.220
E1	4.05	4.60	0.159	0.181
L	0.75	1.50	0.030	0.059

Figure 18. SMB footprint, dimensions in mm (inches)



2.3 SMC package information

Figure 19. SMC package outline

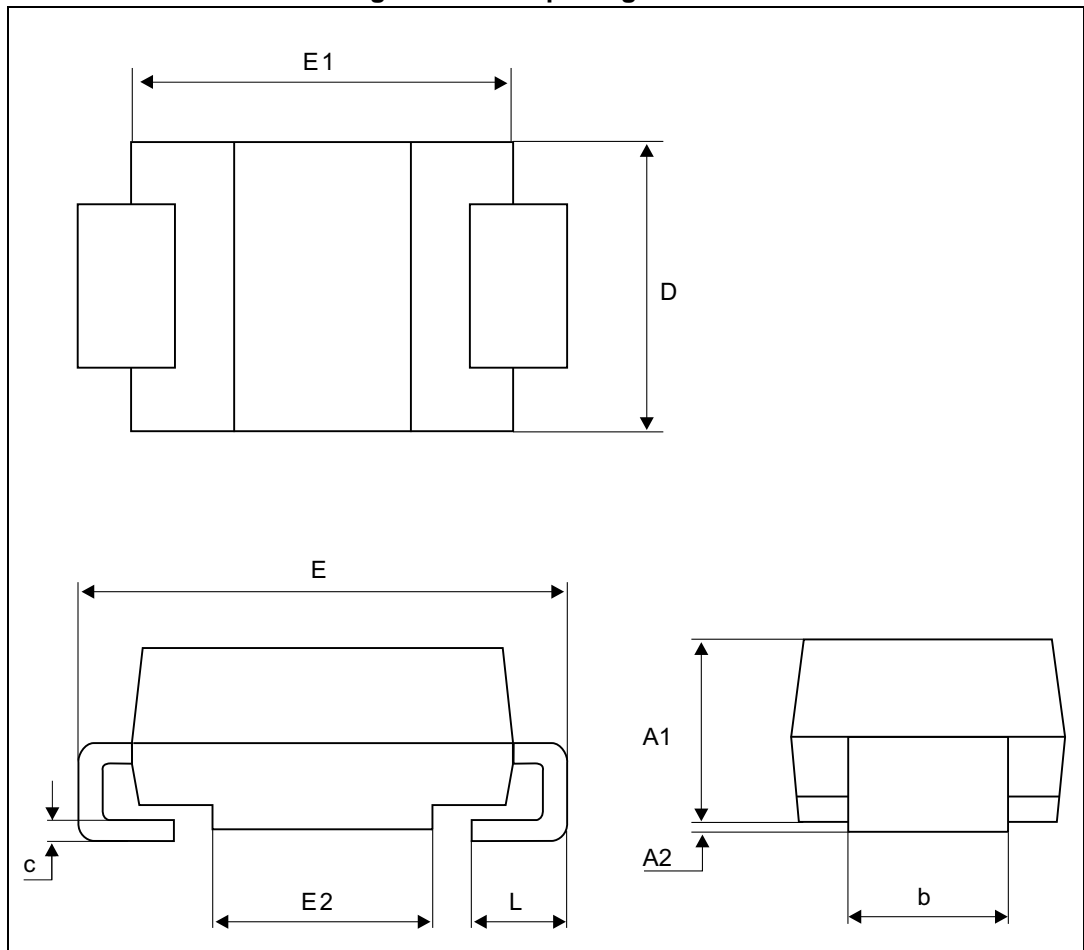
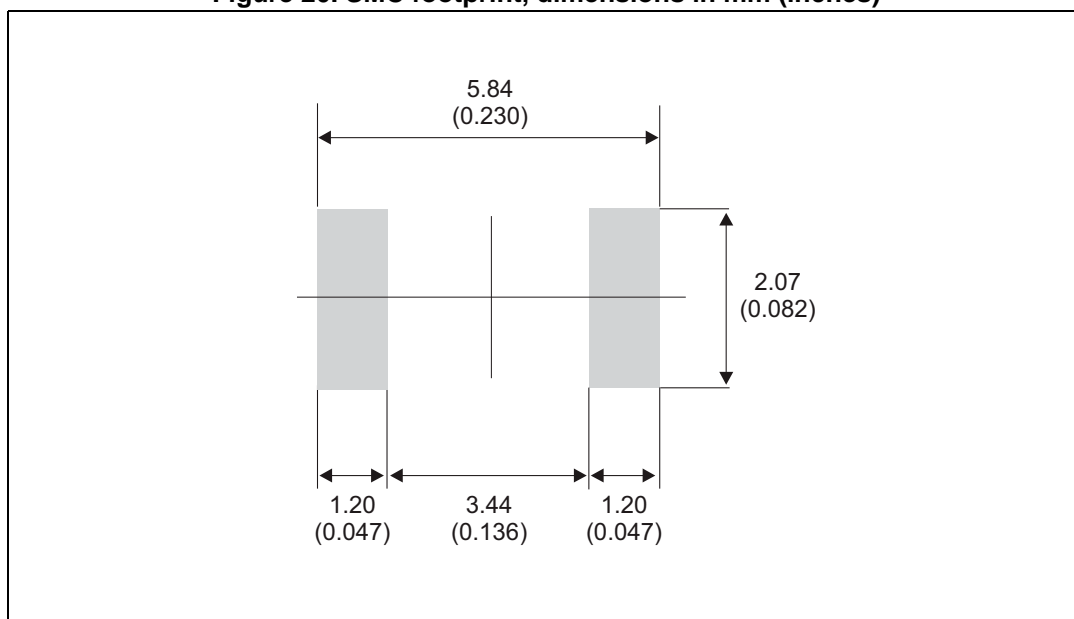

Table 8. SMC package mechanical data

Ref.	Dimensions			
	Millimeters		Inches	
	Min.	Max.	Min.	Max.
A1	1.90	2.45	0.075	0.096
A2	0.05	0.20	0.002	0.008
b ⁽¹⁾	2.90	3.20	0.114	0.126
c ⁽¹⁾	0.15	0.40	0.006	0.016
D	5.55	6.25	0.218	0.246
E	7.75	8.15	0.305	0.321
E1	6.60	7.15	0.260	0.281
E2	4.40	4.70	0.173	0.185
L	0.75	1.50	0.030	0.059

1. Dimensions b and c apply to plated leads

Figure 20. SMC footprint, dimensions in mm (inches)



3 Ordering information

Table 9. Ordering information

Order code	Marking	Package	Weight	Base qty	Delivery mode
STTH4R02B-TR	STTH 4R02	DPAK	0.32 g	2500	Tape and reel
STTH4R02U	4R2U	SMB	0.110 g	2500	Tape and reel
STTH4R02S	4R2S	SMC	0.243 g	2500	Tape and reel

4 Revision history

Table 10. Document revision history

Date	Revision	Changes
03-May-2006	1	First issue.
10-Oct-2006	2	Added SMC package
13-Apr-2010	3	Updated ECOPACK statement. Updated dimensions tables for SMB and SMC.
01-Jul-2010	4	Separated junction to lead values from junction to case values in <i>Table 3</i> .
20-Nov-2014	5	Removed TO-220AC, TO-220FPAC and DO-201AB package informations.
02-Nov-2016	6	Updated DPAK package information and reformatted to current standard.

IMPORTANT NOTICE – PLEASE READ CAREFULLY

STMicroelectronics NV and its subsidiaries ("ST") reserve the right to make changes, corrections, enhancements, modifications, and improvements to ST products and/or to this document at any time without notice. Purchasers should obtain the latest relevant information on ST products before placing orders. ST products are sold pursuant to ST's terms and conditions of sale in place at the time of order acknowledgement.

Purchasers are solely responsible for the choice, selection, and use of ST products and ST assumes no liability for application assistance or the design of Purchasers' products.

No license, express or implied, to any intellectual property right is granted by ST herein.

Resale of ST products with provisions different from the information set forth herein shall void any warranty granted by ST for such product.

ST and the ST logo are trademarks of ST. All other product or service names are the property of their respective owners.

Information in this document supersedes and replaces information previously supplied in any prior versions of this document.

© 2016 STMicroelectronics – All rights reserved

Mouser Electronics

Authorized Distributor

Click to View Pricing, Inventory, Delivery & Lifecycle Information:

[STMicroelectronics:](#)

[STTH4R02S](#) [STTH4R02](#) [STTH4R02B](#) [STTH4R02B-TR](#) [STTH4R02RL](#) [STTH4R02U](#) [STTH4R02D](#) [STTH4R02FP](#)